

hp LaserJet 4100 mfp



i n v e n t

use



hp LaserJet 4100 mfp series multifunction printer



use



© 2001-2004 Copyright Hewlett-Packard Development Company, L.P.

Reproduction, adaptation or translation without prior written permission is prohibited, except as allowed under the copyright laws.

The information contained herein is subject to change without notice.

The only warranties for HP products and services are set forth in the express warranty statements accompanying such products and services. Nothing herein should be construed as constituting an additional warranty. HP shall not be liable for technical or editorial errors or omissions contained herein.

Edition 3, 2/2004

Trademark Credits

Adobe®, Acrobat®, and PostScript® are trademarks of Adobe Systems Incorporated.

AutoCAD® is a U.S. trademark of Autodesk, Inc.

HP-UX Release 10.20 and later and HP-UX Release 11.00 and later (in both 32- and 64-bit configurations) on all HP 9000 computers are Open Group UNIX branded products.

Microsoft®, MS Windows®, Windows®, and Windows NT® are registered trademarks of Microsoft Corporation.

Netscape is a U.S. trademark of Netscape Communications Corporation.

UNIX® is a registered trademark of the Open Group.



ENERGY STAR® is a U.S. registered service mark of the U.S. EPA.



Contents

About this guide

How to use this online guide	7
Navigational features in this guide	7
Features of Acrobat Reader	8
Where to look for more information	10



1 Introduction

Overview	11
Product configurations	12
Product benefits	13
Digital-sending	13
Walk-up copying	13
Network printing	13
Multitasking	13
Product features	14
Parts	16
Embedded Web server	18



2 Basic operations

Overview	19
Using the ADF	20
Using the scanner glass	21
Selecting the output bin	22
Printing to the top output bin	22
Printing to the rear output bin	22
Loading Tray 1	23
Loading Tray 2 and optional Trays 3 and 4	24
Using special media	25
Using small or narrow paper	25
Using letterhead, prepunched, or preprinted paper	25
Using envelopes	26
Using labels	27
Using transparencies	27
Using cards and custom-size or heavy paper	28
Duplex copying and printing	29
Guidelines for duplexing	29
Media placement requiring specific orientation	30
Layout options for duplexing	31
Job-handling priorities	32



3 Control panel and control panel menus

Overview	33
Layout and operation	34
Navigation	35
Status bar	35
Control panel screens	36
Menus	37
Retrieve Job menu	37
Information menu	37
Paper Handling menu	38



Configure Device menu	39
Diagnostics menu	42
Service menu	42
Online Help system	42

4 Walk-up copying

Overview	43
Performing basic copying	44
Copy defaults	44
One-touch copying	44
Multiple copies	44
User-defined copy settings	45
Using the Describe Original screen	45
Using the Copy Settings screen	46
Duplexing a copy job	47
Adjusting the contrast	48
Improving copy quality	48
Reducing or enlarging copies	48



5 Sending to e-mail

Overview	49
Introduction	49
Sending documents	50
Describe Original screen	50
Send Options screen	50
Basic sending procedures	50
Available file formats	52
Address books	53

6 Network printing

Overview	55
Installing the printer software	56
Printer drivers	58
Software for Windows-based computers	59
Software for Macintosh computers	60
Software for networks	60
HP Web JetAdmin	60
UNIX and Linux	61
Performing advanced printing tasks	61
Using features in the printer driver	61
Printing multiple pages on one sheet of media	62
Customizing trays for printing or copying	63
Using the job-storage features	65
Reaching the job storage features	65
Printing stored jobs	66
Deleting stored jobs	66
Printing with the FIR port	67
Preparing to print with Windows	67
Preparing to print with Macintosh computers	67
Printing a job using FIR	68
Interrupting and resuming FIR printing	68



7 Product maintenance

Overview	69
Managing the toner cartridge	70
HP toner cartridges	70

Toner cartridge authentication	70
Toner cartridge life expectancy	70
Toner cartridge storage	70
Toner low and toner out conditions	71
Cleaning the product	71
General guidelines.	71
Cleaning procedure	72
Cleaning the fuser	73
Running the cleaning page automatically	73
Cleaning the ADF paper delivery guide.	74
Cleaning the scanner glass	75
Cleaning the calibration strip	75
Performing preventative maintenance	76



8 Problem solving

Overview	77
Clearing jams	78
Jam locations.	78
Clearing jams from the top cover and toner cartridge area	79
Clearing jams from input trays	80
Clearing jams from the duplexer	81
Clearing jams from the rear output slot	82
Clearing jams from the fuser area	83
Clearing jams from the ADF	84
Solving repeated jams.	85
Understanding control panel messages.	86
Understanding mopy disk-error messages	95
Troubleshooting the hard disk	96
Correcting output quality problems	97
Light print (partial page).	97
Light print (entire page)	97
Specks	97
Dropouts	98
Lines	98
Gray background	98
Toner smear	99
Loose toner	99
Repeating defects	99
Repeating image	100
Misformed characters	100
Curl or wave	100
Page skew	100
Wrinkles or creases.	101
Vertical white lines.	101
Tire tracks	101
White spots on black.	101
ADF recalibration.	102
Troubleshooting PostScript issues.	103
Troubleshooting optional HP Fast InfraRed Connect problems.	104
Troubleshooting an HP Jetdirect print server.	105



9 Service and support

HP customer care service and support	107
Online services	107
Customer support options	108
HP Customer Care Center and product repair assistance for the U.S. and Canada	108
Warranty information	108

Hewlett-Packard limited warranty statement	109
Limited warranty for toner cartridge life	110
HP software license terms	111

Appendix A Specifications

Overview	113
Paper specifications	113
Supported types of paper	117
Guidelines for using paper	118
Labels	119
Transparencies	119
Envelopes	120
Card stock and heavy paper	121
Product specifications	122
Physical dimensions	122
Product weight (without toner cartridge)	123
Environmental specifications	123



Appendix B Ordering information

Available accessories	125
Part numbers	126

Appendix C Regulatory information

FCC regulations	131
Environmental product stewardship program	132
Protecting the environment	132
Material safety data sheets	133
Safety statements	135
Laser safety statement	135
Canadian DOC regulations	135
VCCI statement (Japan)	135
Laser statement for Finland	136

Appendix D System administrator guide

Overview	137
Using the embedded Web server	138
Configuring and verifying an IP address	139
TCP/IP assignment	139
Verifying the TCP/IP configuration	139
Changing an IP address	140
Configuring multitasking priorities	141
Scan ahead submenu	141
Auto job interrupt submenu	141
Copy job interrupt submenu	141
Hold off print job submenu	142
Reset copy timeout submenu	142
Reset send timeout submenu	142
Using digital-sending settings	143
LDAP addressing settings	143
Preferences settings	143
Using HP Web JetAdmin with the embedded Web server	144
Configuring product alerts	144
Installing a DIMM	145
Understanding printer commands	147



Index

About this guide

How to use this online guide

This guide is provided in an Adobe® Acrobat® portable document format (PDF file). This section familiarizes you with how to use PDF documents.

The Adobe Acrobat Reader is not included in the product software, but can be downloaded from <http://www.adobe.com>.



Navigational features in this guide



Click the **Table of Contents** icon to go to the table of contents for the online guide. The entries are linked to their related locations in this *use* guide.



Click the **Introduction** icon to return to this section for tips about using this *use* guide.



Click the **Index** icon to go to the index for the online guide. The index entries are linked to their related topics.



Click the **Up Arrow** icon to go to the previous page.



Click the **Down Arrow** icon to go to the next page.



Features of Acrobat Reader

Finding information in PDF documents

To find specific information in a PDF document, click **Contents** or **Index** in the upper-left corner of the Acrobat Reader window, and then click the topic you want. You can also use the Acrobat Reader **Find** tool.

Viewing PDF documents

For complete instructions about how to view PDF documents, see the online Help included with Acrobat Reader.



Magnifying the page view

You can use the zoom-in tool, the magnification box on the status bar, or the toolbar buttons to change the screen magnification. When you zoom in on a document, you can use the hand tool to move the page around.

Acrobat Reader also offers magnification-level choices that control how the page fits on the screen:



Fit Page scales the page to fit within the main window.

Fit Width scales the page to fit the width of the main window.

Fit Visible fills the window with the page's content area only.



To increase magnification: Select the zoom-in tool and click on the document page to double the current magnification.

To decrease magnification: Select the zoom-in tool while holding down **CTRL** (Microsoft® Windows®, and UNIX®) or **Option** (Macintosh), and click the center of the area you want to reduce.

Paging through a document

The following options are available for paging through a document.

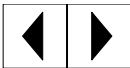

To go to the next page: Click the **Next Page** icon on the toolbar, or click the **Right Arrow** or **Down Arrow** icon.

To return to the previous page: Click the **Previous Page** icon on the toolbar, or click the **Left Arrow** or **Up Arrow** icon.

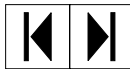

To go to the first page: Click the **First Page** icon on the toolbar.

To go to the last page: Click the **Last Page** icon on the toolbar.



To jump to a specific numbered page: Click the page number box on the status bar at the bottom of the main window, type the page number, and click **OK**.



Browsing with thumbnails

A thumbnail is a miniature view of each document page. You can display thumbnails in the overview area. Use the thumbnail icons to jump quickly to a page and to adjust the view of the current page.



Click a thumbnail to move to the page it represents.

Finding words

Use the **Find** tool to find part of a word, a complete word, or multiple words in the active document.



Click the **Find** icon, or click **Find** on the **Edit** menu.



Printing the guide

To print selected pages: On the **File** menu, click **Print**. Click **Pages**. In the **From** and **To** boxes, type the range of pages you wish to print. Then click **OK**.

To print the entire document: On the **File** menu, click **Print**. Click **All n pages** (*n* represents the total number of pages in the document), and then click **OK**.

Note

Go to <http://www.adobe.com/> for the latest versions and additional languages of Adobe Acrobat Reader.



Where to look for more information

The following references are available for this product (see below). You can also see the *HP Jetdirect Print Server Administrator's Guide*. Additional information is available at <http://www.hp.com/lj4100mfp>.

- *start guide*

This guide provides information for setting up the HP LaserJet 4100 mfp series, and is included with the product. For additional copies, contact an HP-authorized dealer.



- *how-to poster*

This wall poster, also included with the product, provides quick-reference information for commonly performed tasks. For additional copies, contact an HP-authorized dealer.



- Online Help

Online Help provides information about the options available from the printer drivers. Several detailed, preformatted Help documents are also available through the Help feature. Help files can be viewed and printed through the printer driver.



- HP Fast InfraRed Receiver User Guide

This guide provides information about using and troubleshooting the HP Fast InfraRed Receiver (FIR).

- Accessory guides

These guides are included with accessories or toner cartridges, and provide instructions for installation and use.



1 Introduction

Overview

Congratulations on your purchase of the HP LaserJet 4100 mfp series multifunction printer (MFP). This product combines convenient send-to-e-mail and one-touch copying features with high-quality laser printing.

See the *start* guide included with the product for setup instructions.

Before using the product, familiarize yourself with the following features described in this chapter:

- product configurations
- product benefits and features
- parts and their locations
- basic features of the embedded Web server



Product configurations

The HP LaserJet 4100 mfp series is available in two configurations:

HP LaserJet 4100 mfp (C9148A)

- 64 MB RAM; 5 GB (or larger) hard disk for RIP ONCE, transmit and scan once, job retention, and font, form, and signature storage
- HP Jetdirect 10/100Base-TX print server card for network connection
- 100-sheet media input tray
- 500-sheet media input tray
- automatic document feeder (ADF) with 30-sheet capacity

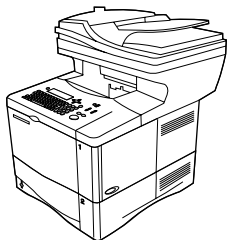

HP LaserJet 4101 mfp (C9149A)

- 64 MB RAM; 5 GB (or larger) hard disk for RIP ONCE, transmit and scan once, job retention, and font, form, and signature storage
- HP Jetdirect 10/100Base-TX print server card for network connection
- 100-sheet media input tray
- two 500-sheet media input trays
- duplexer for automatic duplexing (two-sided printing)
- ADF with 30-sheet capacity

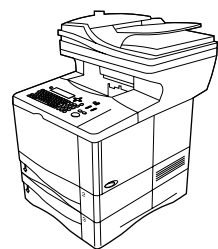

Product benefits

The HP LaserJet 4100 mfp series is designed to be shared by a workgroup and lets you print, make copies, and e-mail digital documents with a single device. The MFP's multitasking capability enables multiple functions to proceed simultaneously.

Note

If the product is to be used as a network printer, the printer drivers must be installed on all computers that will send print jobs to the MFP.



Digital-sending

Digital-sending is similar to faxing information, but offers significant advantages.

- sends e-mail to multiple e-mail addresses simultaneously, saving time and delivery costs
- ensures privacy by sending information directly to e-mail in-boxes rather than to a fax machine, which might have many users
- delivers files at near-original quality in black and white or in color
- sends files in PDF, JPEG, TIFF, or M-TIFF file formats, which can be modified by the recipient as needed



Walk-up copying

The product offers efficient copying services for the workgroup. Making a copy is as easy as pressing the **START** button to use the system defaults. The product offers full office copying functionality.

Network printing

The product is fully compatible with other HP LaserJet printers. When the installation software is loaded, network printing is available through the HP Jetdirect 10/100Base-TX print server card that is supplied with the product. Use the parallel port or the optional Fast InfraRed receiver (FIR) port for direct printing.

Multitasking

The HP LaserJet 4100 mfp series allows full multitasking capabilities to enhance office efficiency. System defaults can be set to define how multiple incoming jobs are managed and how these defaults can be overridden to meet special requirements.



Product features

Product speed and throughput

- printing and copying of letter-size media at 25 pages per minute (ppm) or A4-size media at 24 ppm
- monochrome scanning of letter-size originals at 25 ppm or A4-size originals at 24 ppm, and color scanning at 8 ppm
- instant-on fuser
- scan-once copying and transmit-once printing
- RIP ONCE print and copy capability
- scan-ahead capability to start copying or sending while the printer is busy
- monthly duty cycle of 150,000 pages



Image quality

- FastRes 1200: 1200 dpi (dots per inch) print quality for fast, high-quality printing of business text and graphics
- ProRes 1200: 1200 dpi for printing best image quality
- copying and scanning at a resolution of 600 pixels per inch (ppi)
- up to 256 levels of gray for smooth, photo-like images
- HP UltraPrecise toner cartridge for crisp, sharp output

Paper handling

- HP LaserJet 4100 mfp: the 100-page and 500-page input trays are standard
- HP LaserJet 4101 mfp: the 100-page and two 500-page input trays are standard
- capable of printing and copying on a wide range of media sizes, types, and weights
- expandable to hold up to 1600 sheets of media
- standard 250-sheet face-down output
- duplexer is standard on HP LaserJet 4101 mfp
- scanner glass handles media sizes up to letter/A4 sizes
- ADF with 30-page capacity handles media sizes up to legal size

Printing features

- fully compatible with HP LaserJet 4100 series printers
- HP printer command language (PCL) 6, PCL 5e, and PostScript® (PS) 3 Emulation
- 80 fonts for Microsoft Windows
- additional fonts available for download from the Internet



Digital-sending capability

- full send-to-e-mail capability
- SMTP mail service support
- Lightweight Directory Access Protocol (LDAP) compatibility
- digital-sending service software standard with the HP LaserJet 4101 mfp



Copying capability

- easy-to-use copy functionality
- document collation
- multiple copies
- multiple pages per sheet (n-up)
- document reduction to 25 percent and enlargement to 400 percent in one-percent increments
- automatic page-to-page enlargement or reduction
- image-quality improvement through background removal, best-quality mode, and contrast adjustment



Toner cartridge

- standard 10,000-page toner cartridge
- no-shake cartridge design
- HP smart print supplies system verifies that authentic HP toner cartridges are installed
- supplies status page contains toner gauge, page counter, and information about media sizes
- supplies purchasing available through embedded Web server or online

Expandable design

- stackable 500-sheet trays (up to two additional trays can be added to the basic product)
- power envelope feeder (holds as many as 75 envelopes)
- duplexer (standard with the HP LaserJet 4101 mfp)
- Fast InfraRed printing adapter (FIR port)
- digital-sending service software standard with the HP LaserJet 4101 mfp
- memory can be expanded by installing additional dual inline memory modules (DIMMs)



Parts

Product parts (front view)

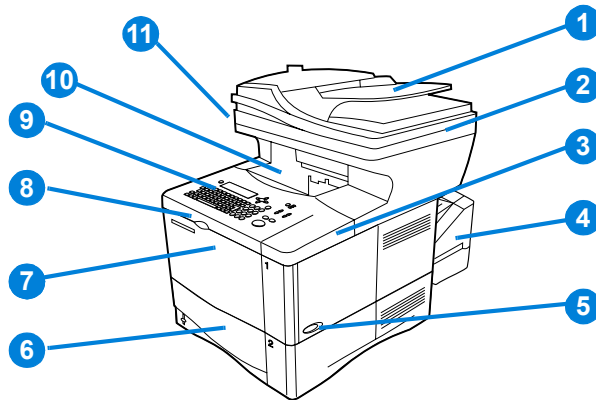

- 1 ADF
- 2 ADF cover (lifts for access to scanner glass)
- 3 Top cover (access to toner cartridge; serial and part numbers are underneath cover)
- 4 Duplexer or Tray 2 dust cover (dust cover is removed if duplexer is installed)
- 5 Power switch
- 6 Tray 2 (holds 500 sheets; Trays 3 and 4 are stacked below, if installed)
- 7 Tray 1 (holds 100 sheets)
- 8 Access to toner cartridge
- 9 Control panel
- 10 Output bin
- 11 Scanner lock (located on the left side of the MFP)



Product parts (back view)

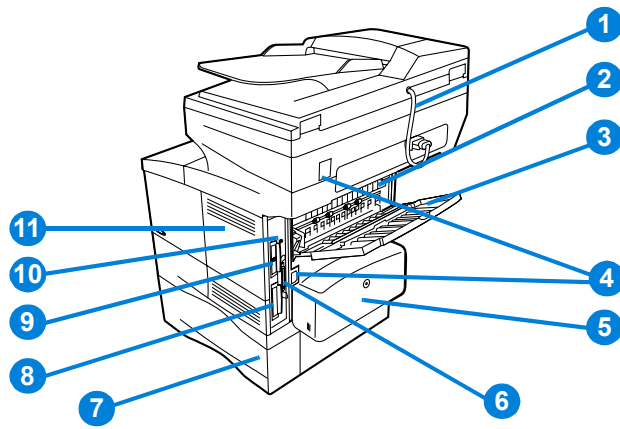

- 1 ADF connector cable
- 2 Fuser (can be removed to clear jams)
- 3 Rear output slot (straight-through paper path)
- 4 Power/jumper cable connectors
- 5 Duplexer or Tray 2 dust cover (dust cover is removed if duplexer is installed)
- 6 Parallel interface port
- 7 Tray 3
- 8 Hard disk
- 9 HP Jetdirect print server card
- 10 Fast InfraRed Connect (FIR port)
- 11 Memory access door (more than one DIMM can be installed)



Embedded Web server

The product has an embedded Web server that allows the system administrator to configure and manage all networked HP LaserJet 4100 mfp series products remotely. The MFP must be connected to a local area network (LAN) through the HP Jetdirect card before the embedded Web server can be enabled.

The embedded Web server should be used only by a system administrator. See [“System administrator guide” on page 137](#) for details about product configuration and management using the embedded Web server.



2 Basic operations

Overview

This chapter introduces the basic copying, sending, and printing operations of the HP LaserJet 4100 mfp series. Specific information about each of these functions is presented in later chapters. This chapter includes these topics:

- using the ADF
- using the scanner glass
- selecting the output bin
- loading Tray 1
- loading Trays 2, 3, and 4
- printing and copying on both sides of paper (duplexing)
- using special media, such as envelopes, letterhead, and transparencies
- understanding job-handling priorities



Using the ADF

Using the automatic document feeder (ADF) is a fast, convenient way to feed multipage originals for copying or digital-sending. You can load the ADF with as many as 30 sheets of paper. The ADF accepts documents that meet the following specifications:

- single-sided or double-sided originals
- documents on standard letter-, A4-, and legal-size paper
- documents ranging in size from 148.5 by 210.0 mm (5.9 by 8.3 inches) to 215.9 by 355.6 mm (8.5 by 14.0 inches)
- documents ranging in weight from 60 to 135 g/m² (16 to 36 lb)
- documents that are free of tears or perforations
- documents that are square or rectangular and in good condition (not fragile or worn)
- documents that are free of glue, correction fluid, or wet ink



Note

Do not use multipart forms.

The ADF passes the original document across the scanner glass, and returns it to the upper-level tray located to the right of the ADF. Copies made using the ADF are delivered to the output bin beneath the scanner.

General guidelines for using the ADF

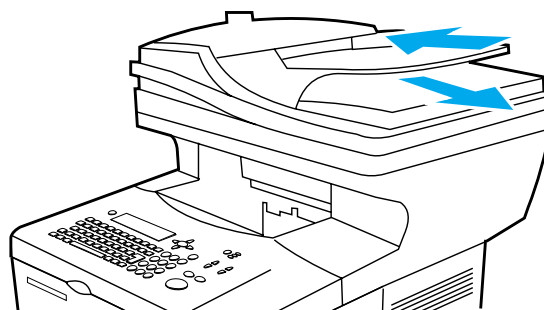

Before placing documents into the ADF, prepare the documents by doing the following:

- Flatten curls or wrinkles.
- Remove staples, paper clips, sticky notes, and similar materials.



Using the scanner glass

You can also use the digital-sending and copying features by using the scanner glass, located below the ADF. The scanner can accommodate letter- or A4-size and smaller originals, books, manuals, receipts, and similar documents. Irregular and worn documents, stapled documents, and photographs can also easily be sent or copied using the scanner glass. Multiple-page, letter-size documents can be fed using the ADF. To send or copy larger documents, see [“Using the ADF” on page 20](#).



General guidelines for using the scanner glass

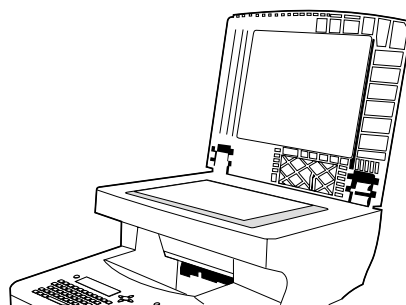

- 1 Open the scanner cover and place the original document face down on the scanner glass. Lower the cover.
- 2 On the control panel, select the desired sending or copying options. See [“Walk-up copying” on page 43](#) and [“Sending to e-mail” on page 49](#) for specific information about using these functions.
- 3 After making your selections, press **START**. Copies are sent to the output bin beneath the scanner.
- 4 When the scan is complete, remove the original document from the scanner glass.



Selecting the output bin

The printer has two output locations: the rear output bin and the top output bin. To use the top output bin, be sure the rear output bin is closed. To use the rear output bin, open it.

- If paper coming out of the top output bin has problems, such as excessive curl, try printing to the rear output bin.
- To avoid paper jams, do not open or close the rear output bin while the printer is printing.



Printing to the top output bin

The top output bin collects paper face-down, in correct order. The top output bin should be used for most print jobs and for transparencies.

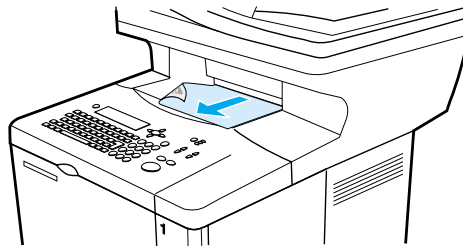

Printing to the rear output bin

The printer always prints to the rear output bin if the bin is open. Paper printed to this bin will be face-up, with the last page on top.

To open the rear output bin, grasp the handle at the top of the bin. Pull the bin down, and slide out the extension.

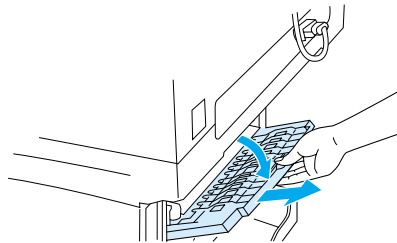

Printing from Tray 1 to the rear output bin provides the straightest paper path (which can reduce curl). Opening the rear output bin might improve performance with the following:

- envelopes
- labels
- small custom-size paper
- postcards
- paper heavier than 105 g/m² (28 lb)



Note

Opening the rear output bin disables the duplexer (if installed) and the top output bin.

Loading Tray 1

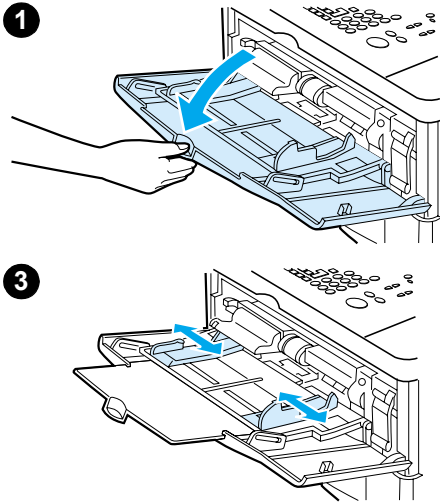

Tray 1 is a multipurpose tray that holds as many as 100 sheets of paper, 10 envelopes, or 20 sheets of cardstock. The default action is to pull media from Tray 1 first. To change the default, see [“Customizing trays for printing or copying” on page 63](#).

Tray 1 provides a convenient way to print envelopes, transparencies, custom-size media, or other types of special media without unloading the other trays. It can also be used as an additional input tray. For supported sizes of media, see [“Supported paper sizes and weights” on page 114](#).

- 1 Open Tray 1.
- 2 Pull out the tray extension.
- 3 Set the side guides to the desired width.
- 4 Load media in the tray.

Note

Make sure that the media fits under the tabs on the guides and not above the load-level indicators.

Generally, load media with the side to be printed facing up, and the top, short edge toward the product. For information about loading special media, see [“Using special media” on page 25](#).

- 5 Adjust the side guides so that they touch the media stack but do not bend the media.

CAUTION

To avoid jams, do not load trays while the product is printing.



Loading Tray 2 and optional Trays 3 and 4

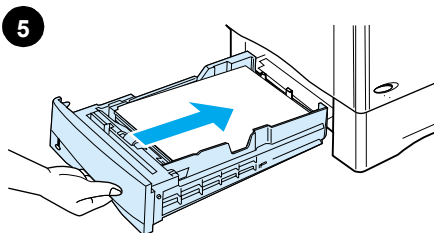
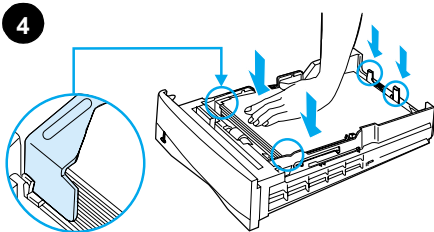
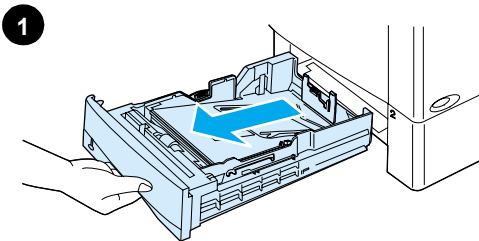

Trays 2, 3, and 4 are 500-sheet media input trays. Tray 2 is standard on the HP LaserJet 4100 mfp. Trays 2 and 3 are standard on the HP LaserJet 4101 mfp, and Tray 4 is an available option. Both Trays 3 and 4 are available as options for the HP 4100 LaserJet mfp.

The trays adjust for six standard sizes and many custom sizes (for details, see [“Supported paper sizes and weights for Trays 2, 3, and 4”](#) on page 115). When the paper guides are adjusted properly, the product automatically senses the media size that is loaded.

CAUTION

To avoid jams, do not load trays while the product is printing.

- 1 Pull the tray out of the product.
- 2 Adjust paper guides as needed:
 - To adjust the width, squeeze the lever on the left guide and slide the guides into place.
 - To adjust the length, squeeze the lever on the rear paper guide and slide it to the desired media size until it clicks into place.
 - Squeeze the blue tab on the right side of the tray and move it to the correct position for the media size.
- 3 Load paper into the tray.

Note

Load media with the side to be printed on face down and the top edge of the media towards you.

- 4 Make sure the paper is flat in the tray at all four corners and below the front and back tabs.
- 5 Slide the tray back into the product.

Note

If the tray is not properly adjusted, the control panel might show an error message or the media might jam.

For information about duplexing, see [“Media placement requiring specific orientation”](#) on page 30. For information about loading special media, see [“Using special media”](#) on page 25.



Using special media

This section discusses printing and copying on types of media that require special handling:

- small or narrow paper
- letterhead, prepunched, or preprinted paper
- envelopes
- labels
- transparencies
- cards and custom-size or heavy paper



Using small or narrow paper

Follow these guidelines if you plan to print or copy primarily on small or narrow media:

- Use the 6,000-page toner cartridge (part number C8061A). The toner might leak if large quantities of small or narrow media are printed using the 10,000-page cartridge (part number C8061X). (See [“Ordering information” on page 125.](#))
- Print from Tray 1 to the rear output slot if you experience problems such as jams or curling. Using this output slot provides a straight-through paper path.

See [“Using cards and custom-size or heavy paper” on page 28](#) for further information about printing on non-standard sizes.

Using letterhead, prepunched, or preprinted paper

When printing letterhead, prepunched, or preprinted paper, it is important to orient the paper correctly.

- When using Tray 1, load the paper with the side to be printed facing up, and the top, short edge toward the product.
- For all other trays, load paper with the side to be printed facing down, and the top edge toward you.

Note

Follow the guidelines in this section for printing on one side only. To duplex, see [“Guidelines for duplexing” on page 29.](#)



Using envelopes

You can print many types of envelopes from Tray 1. As many as ten envelopes can be stacked in the tray. For information about acceptable envelope specifications, see [“Envelopes” on page 120](#).

Printing performance depends on the construction of the envelope. Always test a few sample envelopes before purchasing a large quantity. To print envelopes:

- In your software program, set the margins at least 15 mm (0.6 inch) from the edge of the envelope.
- Before you load envelopes, make sure they are flat and not damaged or stuck together.
- Open the rear output slot to create a straight paper path. This produces better results if the envelopes tend to curl. If you print large quantities of envelopes continuously, or if you alternate envelopes with wide paper, you might need to select `SMALL PAPER SPEED=SLOW` in the Fuser Mode option of the Configure Device menu. The proper setting reduces the throughput speed of narrow paper to allow the heat generated from printing to dissipate. Although using this feature slows throughput speed, it helps prevent product damage while ensuring excellent print quality.



CAUTION

Envelopes with clasps, snaps, windows, coated linings, exposed self-stick adhesives, or other synthetic materials can severely damage the product. To avoid jams, emission of noxious fumes, and possible product damage, never print on both sides of an envelope.

Loading envelopes in Tray 1

- Open Tray 1, but do not pull out the extension. You might need to use the extension if you print oversize envelopes.
- Load as many as ten envelopes in the center of Tray 1 with the side to be printed facing up, and the postage-end toward the product. Slide the envelopes into the tray as far as they will go without forcing them.
- Adjust the guides to touch the envelope stack without bending the envelopes. Make sure that the envelopes fit under the tabs on the guides and the envelope feeder is not overfilled.
- Lower the envelope weight onto the stack of envelopes.

Note

Select the envelope size from the software program (if the setting is available) or the printer driver. To print by type and size of media, see [“Specifying type and size of media \(locking trays\)” on page 63](#). If the envelopes curl when printing, open the rear output slot to create a straight-through paper path.

Using an optional power envelope feeder

With the optional power envelope feeder accessory, the product can automatically feed as many as 75 envelopes to the printer. To order a power envelope feeder, see [“Ordering information” on page 125](#). See the documentation included with the accessory for instructions about operation and use.



Using labels

To ensure excellent printing quality and avoid damage to the product, use only labels that are recommended for use in laser printers. Make sure that the labels meet the correct specifications (see [“Labels” on page 119](#)).

Do:

- Print a stack of as many as 50 sheets of labels from Tray 1.
- Load labels in Tray 1 with the side to be printed facing up, and the top, short edge toward the product.



Do not:

- Do not use labels that are separating from the backing sheet or are wrinkled or damaged in any way.
- Do not use labels that have the backing sheet exposed.
- Do not feed a sheet of labels through the product more than once. The adhesive backing is designed for only one pass through the product.
- Do not print on both sides of labels.
- Do not print on sheets from which labels have been removed.



CAUTION

Failure to follow these instructions can damage the product.

Using transparencies

Use only transparencies recommended for use in laser printers. For transparency specifications, see [“Transparencies” on page 119](#).

- Load transparencies face up in Tray 1, with the top toward the product. As many as 50 transparencies can be loaded in Tray 1.
- As many as 50 transparencies can be printed or copied from Tray 2, 3, or 4. Load them with the side to be printed facing down, and the top edge toward you.
- Remove each transparency from the output bin before the next transparency prints.
- Do not feed transparencies through the product more than once.
- Print on only one side of a transparency.
- Place the transparencies on a flat surface to cool after removing them from the product.
- Select the transparency media type in the printer driver so that the product uses the low-fuser mode that is best for printing them.
- Fan the input stack if two or more transparencies feed at the same time.



Using cards and custom-size or heavy paper

Custom-size paper can be printed or copied from any tray. For acceptable paper specifications, see [“Paper specifications” on page 113](#).

Tray	Minimum size	Maximum size
Tray 1	76 by 127 mm (3 by 5 inches)	216 by 356 mm (8.5 by 14.0 inches)
Tray 2, 3, or 4	148 by 210 mm (5.8 by 8.2 inches)	216 by 356 mm (8.5 by 14.0 inches)

The maximum acceptable paper weight is 199 g/m² (53 lb) from Tray 1 and 105 g/m² (28 lb) from Tray 2, 3, or 4.

Note

The control panel can be set to handle only one custom media size at a time. Do not load more than one size of custom media into the product.



Guidelines for using custom paper

- Do not attempt to print on paper smaller than 76 mm (3 inches) wide or 127 mm (5 inches) long.
- In the software program, set the page margins at least 4.23 mm (0.17 inch) from the edges.
- Feed the short edge of the page first.

Setting custom paper sizes

When custom paper is loaded, select the appropriate size settings in the software program (the preferred method), the printer driver, or the control panel.

Note

Settings in the software program and printer driver override control panel settings. Software program settings generally override printer driver settings.

If the desired settings are not available in the software, set the custom paper size on the control panel:

- 1 From the Paper Handling menu, select `TRAY <N> CUSTOM`.
- 2 Using the `TRAY <N> CUSTOM` option, select inches or millimeters as the unit of measurement.
- 3 Using the `TRAY <N> CUSTOM` option, set the dimension for the top edge of the media. This dimension can be 76 to 216 mm (3.0 to 8.5 inches).
- 4 While in the `TRAY <N> CUSTOM` option, set the dimension for the side edge of the media. This dimension can be 127 to 356 mm (5 to 14 inches). For example, if the custom paper is 203 by 254 mm (8 by 10 inches), set the front-edge dimension to 203 mm and the side-edge dimension to 254 mm.
- 5 If custom media is loaded into Tray 1, set `TRAY 1 MODE=CASSETTE` and then set `TRAY 1 SIZE=CUSTOM` from the Paper Handling menu in the control panel. See [“Customizing Tray 1 operation” on page 63](#). If custom media is loaded in Tray 2, 3, or 4, be sure that the paper size slider is set to **Custom** (see [“Loading Tray 2 and optional Trays 3 and 4” on page 24](#)). For more information see [“Customizing trays for printing or copying” on page 63](#).



Duplex copying and printing

If a duplexer is installed, you can print or copy on both sides of the paper. The duplexer supports the following media sizes:

- Letter
- Legal
- Executive
- A4
- B5 (JIS)

The duplexer does not support custom sizes.

Note

The Tray 2 dust cover must be removed when the duplexer is installed. See the documentation included with the duplexer for installation and usage instructions.

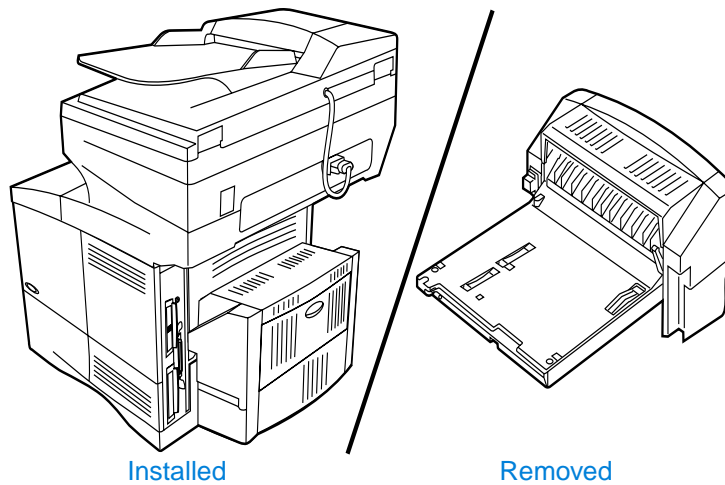

Guidelines for duplexing

- Do not print or copy on both sides of labels, transparencies, envelopes, vellum, or media heavier than 105 g/m² (28 lb). Jams might occur with these types of media, and damage to the product might occur with labels.
- You might need to configure the printer driver to recognize the duplexer. See the printer driver online Help for details.
- To duplex, make the appropriate selection in your software program or printer driver. See the printer driver Help.
- If you do not use the printer driver that came with the product, you might need to change the **Duplexing** setting in the Printing menu to **DUPLEXING=ON**. Also in the Printing menu, set **Binding** to long-edge or short-edge. For more information, see [“Layout options for duplexing” on page 31](#).
- Close the rear output bin when using the duplexer. Opening the rear output bin disables the duplexer.



Media placement requiring specific orientation

Several kinds of paper require a specific orientation when you duplex—for example, letterhead, preprinted paper, and paper with watermarks or prepunched holes. The duplexer prints or copies on the second side of the paper first. Orient the paper in the trays as shown below.

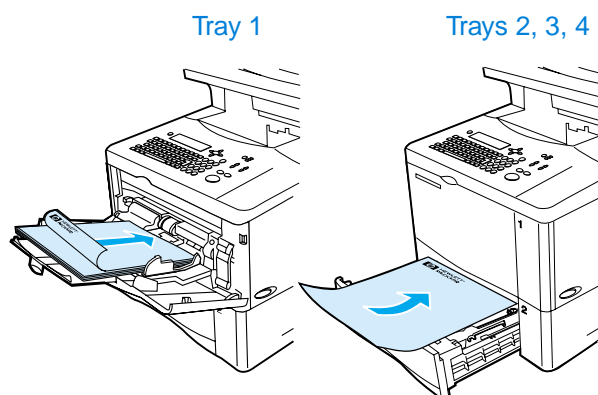

When using Tray 1, load the paper with the front side facing down and the top toward you. For all other trays, load the paper with the front side facing up and the top toward the front of the printer as indicated in the illustration.



Layout options for duplexing

The four available duplexing orientation options are shown below. These options can be selected in the printer driver, through the Copy Settings screen, or by selecting the **BINDING** option from the Printing menu at the control panel.

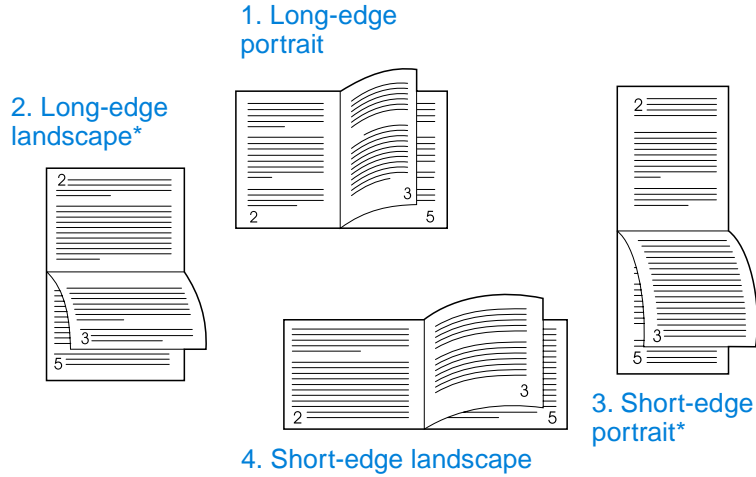

- | | |
|-------------------------------|---|
| 1 Long-edge portrait | This is the default product setting and the most common layout used. Every printed image is oriented right-side up. Facing pages are read from top to bottom on the left page, then from top to bottom on the right page. |
| 2 Long-edge landscape | This layout is often used in accounting, data processing, and spreadsheet programs. Every other image is oriented upside down. Facing pages are read continuously from top to bottom. |
| 3 Short-edge portrait | This layout is often used with clipboards. Every other printed image is oriented upside down. Facing pages are read continuously from top to bottom. |
| 4 Short-edge landscape | Each printed image is oriented right-side up. Facing pages are read from top to bottom on the left page, then from top to bottom on the right page. |

Note

For the binding options designated with an asterisk (*) in the diagram above:
 When using Windows drivers, select **Flip Pages Up**.
 When making copies, select the **2 - Flipped** option on the Copy Settings screen.



Job-handling priorities

The HP LaserJet 4100 mfp series is designed to handle multiple jobs efficiently. Scanning and printing functions operate independently. You can use the scanner for digital-sending while a network printing job is underway, and printing can proceed while the scanner is in use.

- To scan a job for sending or copying while printing is underway, place the document in the ADF or on the scanner glass and press **START**.
- If the MFP is printing and a copy is required, the copy job can be programmed and scanning will continue.
- The system can also be configured to allow you to interrupt a current printing or copying job. You are asked if you wish to interrupt the current job or wait until it has finished. If you interrupt the job, it resumes as soon as your walk-up job is complete.



Note

Job-handling priorities can be changed by the system administrator through the System Setup menu either at the control panel or through the embedded Web server or HP Web JetAdmin. See [“Configuring multitasking priorities” on page 141](#).



3 Control panel and control panel menus



Overview

This chapter presents a general overview of the control panel and the control panel menus. Specific control panel functions that pertain to copying, sending, and printing tasks are presented in later chapters of this guide.

The HP LaserJet 4100 mfp series control panel supports the product's convenience copying and digital-sending functionality as well as walk-up device configuration. The control panel offers all the options and capabilities that you expect from a standard copier, as well as full digital-sending capabilities.

The control panel provides:

- a graphical user interface.
- a numerical keypad for numeric entry such as PIN numbers and number of copies.
- a keyboard for typing e-mail addresses and other data.
- clear feedback during interaction with the control panel.
- status messages, such as information about trays and the toner cartridge.
- support for learning how to use the product's features.
- instructions and graphics to help resolve jams and other problems.



Layout and operation

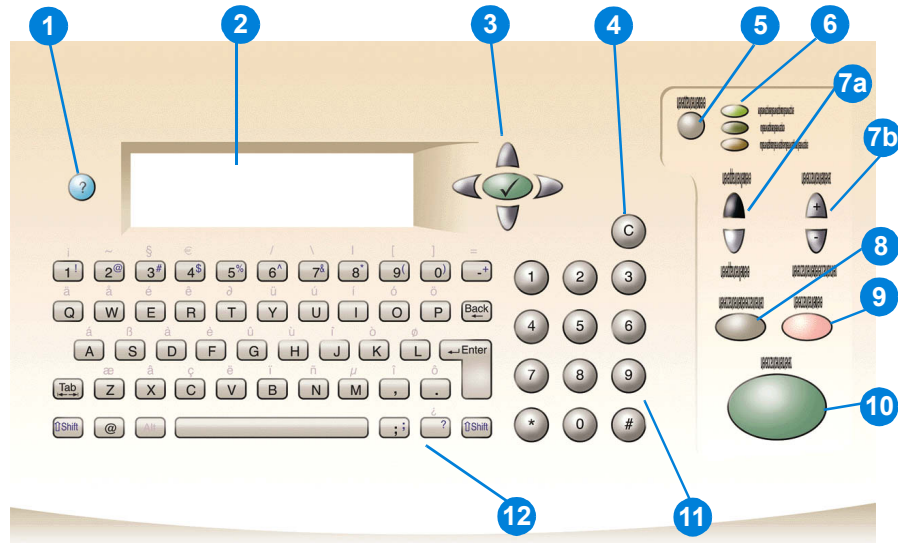

- 1 ? (Help): provides Help about the control panel display when problems occur.
- 2 Control panel display.
- 3 Navigation buttons: four arrow buttons that are used to move among elements on the control panel display. Use the central ✓ button to choose an element or enter a menu.
- 4 C (Clear): resets the copy count or other numeric entries.
- 5 MENU: use to choose device configuration menus on the control panel. See [“Menus” on page 37](#) for additional information.
- 6 Status lights: green Ready light, green Data light, and red Attention light.
- 7 a. Light and dark buttons: use to increase or decrease the copy image brightness.
b. Reduce and enlarge buttons: use to scale the copy size.
- 8 RESET: returns all current job settings to their default values.
- 9 STOP: cancels a copy, sending, or print job.
- 10 START: use to begin or resume a job.
- 11 Numeric keypad: use to specify the number of copies. The keypad can also be used to type numerical values in other modes.
- 12 Keyboard: use for digital-sending features and for typing other data.



Navigation

By pressing the arrow navigation buttons, you can shift focus between objects on the screen to describe the document to be handled and the actions to be performed. A bold border around a graphic object or a reverse video effect in a text list indicates the current focus. Use the central ✓ button to enter menus.

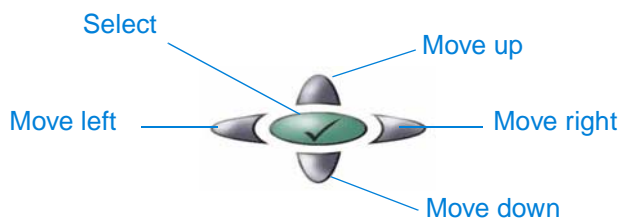

Status bar

The status bar is the uppermost line of available text on the control panel display.

- The status line shows both product status messages and user prompts. When the product is idle, this line displays `READY TO COPY`, `ACCEPTING COPY JOBS`, or `READY`. During scanning, the line might read `SCANNING PAGE x`. During copying, you might see `DATA RECEIVED PROCESSING JOB`. Error messages are not communicated on the status line, but they appear in a text box overlay that blocks normal screen views until the message is cleared.
- The copy count shows the number of copies selected. This selection is made using the keypad. Acceptable values are from 1 to 99.



Control panel screens

Use the screens of the control panel display to describe the original document and to specify the actions to be taken and their parameters. The primary screens are:

- Describe Original
- Copy Settings
- Send Options

These screens are reached through the top-level screen, shown here.

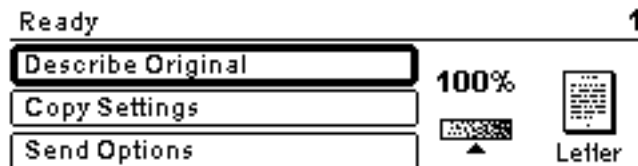

The Describe Original screen, which is used for both digital-sending and copying, is discussed in the following section. The other screens are addressed in the chapters “Walk-up copying” on page 43 and “Sending to e-mail” on page 49.

In the Describe Original screen, you can describe the following aspects of the original document:

- Size (Letter, ADF only, Executive, A4, A5, or B5)
- Sides to be copied or sent (1 or 2)
- Content (Text, Mixed or Photo)

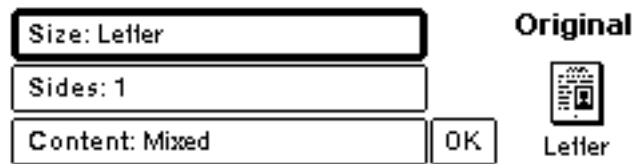

Use the navigation buttons to change a setting. Press ✓ to view available options. Select the desired options using ✓, and navigate to **OK**. Then press ✓ to return to the Describe Original screen. The left-page icon is updated to reflect the selected settings.

Making copies without describing the original

The HP LaserJet 4100 mfp series factory defaults are set to allow you to place an original in the ADF or on the scanner glass and press **START** without having to describe the original. Place the document to be copied on the scanner glass or into the ADF, type the number of copies to be made, and press **START**.

After you press **START**, your copy will be processed with these characteristics:

- one page per sheet
- single-sided
- mixed text, graphic or photo content
- scaled at 100 percent
- medium contrast

The default page size is determined by locale. Letter-size is the default in North America and A4 is the default paper size in Europe and Asia.



Menus

The HP LaserJet 4100 mfp series uses a system of control panel menus to set job parameters, set system defaults, and manage product performance and features. Many of the menu options can also be configured by a system administrator through the embedded Web server or through HP Web JetAdmin.

Menu options are reached by pressing the **MENU** button on the right side of the control panel display and scrolling through the list to locate the option you want to use. The following menus are available.

- Pause/Resume
- Retrieve Job
- Information
- Paper Handling
- Diagnostics
- Configure Device
- Service (password-protected)



Retrieve Job menu

The product offers several job storage features that allow you to retain printed jobs in memory for future use. Stored jobs are listed in the menu by user name. The job-storage features are:

- **Quick Copy jobs:** allows you to print the required number of copies of a job and store a copy on the hard disk for later printing.
- **Proof-and-hold jobs:** allows you to print and review a single copy of a job and later print additional copies.
- **Stored jobs:** stores a print job permanently on the hard disk.
- **Private jobs:** allows you to prevent a job from printing until the job is released at the control panel by typing a four-digit personal identification number (PIN).

Note

Stored jobs are created through the printer driver in the software program.

Information menu

The Information menu offers the following options.

- 1 **Print menu map:** generates and prints a menu map that shows the layout and current settings of all control panel display items.
- 2 **Print configuration:** prints a page showing the current printer configuration. The page includes usage information and shows the remaining life of printer consumables. If an EIO card is present, EIO information is also shown on the configuration page.
- 3 **Print supplies status:** shows the number of pages remaining for the toner cartridges and maintenance kits. The page shows part numbers for reordering.
- 4 **Print usage:** contains information that can be used for cost accounting (available if a hard disk is installed).
- 5 **Print file directory:** generates a directory page for all installed mass-storage devices. This option appears only if mass storage that contains a recognized file system is currently installed.
- 6 **Print PCL font list:** generates a typeface list of all PCL fonts available to the printer.
- 7 **Print PS font list:** generates a typeface list of all PS fonts available to the printer.



Paper Handling menu

The Paper Handling menu options allow you to specify how the input trays are configured.

- 1 **Tray 1 mode:** allows you to select the mode of operation for multipurpose Tray 1. Choices are:
 - **First**
 - **Cassette**
- 2 **Tray 1 size:** allows you to select the size of the paper present in Tray 1. Choices are:
 - **Any**
 - **Custom**
 - **Letter**
 - **Legal**
 - **Executive**
- 3 **Tray 1 type:** sets the media type in Tray 1 (displayed only if the **Tray 1 mode** setting is **Cassette**). Choices are:
 - **Plain**
 - **Preprinted**
 - **Letterhead**
 - **Transparency**
 - **Prepunched**
 - **Labels**
- 4 **Tray <n> size:** configures the media size for Trays 2, 3, and 4.
- 5 **Tray <n> type:** configures the media type for Trays 2, 3, and 4.
- 6 **Tray <n> custom:** sets a custom media size for Trays 2, 3, and 4. Media can be specified by:
 - **unit of measure:** millimeters or inches
 - **x and y dimensions:** width and length of the custom paper in Tray <n> stated in the selected unit of measure
- 7 **Fuser modes:** sets the type of media to be used and then establishes the fuser mode, or fuser temperature, appropriate for the chosen media type.



Configure Device menu

The Configure Device menu is used to establish the product's default settings. These settings are set by the system administrator either at the control panel display or through the embedded Web server (see "[System administrator guide](#)" on page 137). The selected defaults can be locked by the administrator.

You can override the default settings at the control panel display for the current job only.

The Configure Device menu includes the following options. Choices are made using ✓.

1 Originals: sets defaults for originals.

- paper size
- duplexing: on or off
- number of sides
- content: text, mixed or photo
- contrast: range is 0 to 8

2 Copying: sets the default number of copies to be printed for a standard print job.

- number of sides: 1 or 2
- image quality: normal or best
- collation: on or off
- paper destination: output bin or rear output slot
- copies: default copy number; range is 1 to 999, default is 1
- background removal: range is 0 to 8

3 Sending

- e-mail settings
 - scan preference: black and white, color
 - file type: PDF, TIFF, M-TIFF, JPEG
 - from, subject, body text: user enters information
 - Find send gateways: the product searches for a gateway
 - SMTP gateway: the user defines the SMTP gateway address
 - LDAP gateway: the user defines the LDAPP gateway address
 - Test send gateway: the product tests the current gateway connection

4 Printing

- copies: 1 - 32,000, default is 1
- default paper size: any supported media size, including envelopes
- default custom paper size: custom media sizes
- override A4/letter: automatic switching between A4 and letter media sizes
- duplex: on or off as default
- manual feed: supports use of Tray 1
- Courier font: regular or dark
- wide A4: adjusts printable area of A4 paper
- print PS errors: determines printing of a PS error page
- PCL: sets parameters for PCL printing



Print Quality menu

1 Set registration

2 **Resolution:** sets the default printer resolution. The system default is FastRes 1200. Options are:

- 300 dpi resolution
- 600 dpi resolution
- FastRes 1200: 1200 dpi output at 600 dpi print speed

3 **REt (Resolution Enhancement technology):** allows four levels of enhancement, including **Off**. Default is **Medium**.

4 **EconoMode:** economy printing mode on or off. Default is **Off**.

5 **Toner density:** sets the density of the toner. Default is **3**.



6 **Small paper mode:** supports printing of smaller media. Default is **Normal**.

7 **Auto cleaning:** automatically generates a page that cleans excess toner off the pressure roller in the fuser at a user set interval (default interval is every 2000 pages).

8 **Create cleaning page:** generates a page that cleans excess toner off the pressure roller in the fuser.



System Setup menu

- 1 **Job storage limit:** sets a limit of the number of jobs that can be stored.
- 2 **Job held timeout:** sets the time that Quick Copy jobs are kept before being automatically deleted from the queue.
- 3 **PowerSave time:** sets the length of idle time before entering PowerSave mode.
- 4 **Copy/send settings:** determines product settings for copy/send timeouts, job interrupts, and scan ahead option (the ability to send digital documents while a print job is processing). 
- 5 **Personality:** sets the default personality (PCL, PS, or Auto).
- 6 **Clearable warnings:** sets the length of time that a clearable warning appears on the control panel display. 
- 7 **Auto continue:** determines printer behavior when an auto-continue error is generated. 
- 8 **Toner low:** determines whether the product continues or stops printing during a low-toner situation.
- 9 **Toner out:** determines whether the product continues or stops printing during a out-of-toner situation.
- 10 **Jam recovery:** configures how the product handles pages after a jam.
- 11 **Language:** allows user to set default user language.

I/O (input/output) menu

- 1 **I/O timeout:** sets the product's default input/output timeout (in seconds).
- 2 **EIO 1 JetDirect Menu:** configures the HP JetDirect printer options.



Resets menu

- 1 **Restore factory settings:** clears the page buffer, removes all perishable personality data, and resets parameters to factory defaults.
- 2 **PowerSave:** turns **PowerSave On** and **Off**.
- 3 **Lock carriage:** sends the scanner carriage back to the home position (if not already there) so that it can be manually locked for product transportation.
- 4 **Clear address book:** removes all user entered e-mail address in the address book.



Diagnostics menu

The system administrator uses the Diagnostics menu to identify, analyze, and correct system problems.

- 1 **Print event log:** generates an ordered listing of the last 50 entries in the event log.
- 2 **Show event log:** allows scrolling through the event log from the control panel.
- 3 **Paper path test:** generates a test page to test the paper-handling features.
- 4 **Calibrate scanner:** allows leading edge calibration of the ADF.
- 5 **Scanner:** allows testing functionality of the scanner sensors, ADF output motor, scanner motor, pickup solenoid, and lamp.
- 6 **Control panel:** allows testing functionality of the control panel LEDs, display, and buttons.



Service menu

The Service menu is used by HP-authorized service representatives only, and is protected by an eight-digit PIN. Service functions include:

- Clear event log
- Total page count
- Maintenance count
- Maintenance interval
- Serial number

Online Help system

The product features an online Help system that provides instructions for resolving common printing, copying, and sending problems. To gain access to Help, press the ? key.



4 Walk-up copying

Overview

You can easily make black-and-white copies by using the HP LaserJet 4100 mfp series. This chapter provides instructions for making copies and changing copy settings.

The MFP functions as a standalone walk-up copier—you do not have to have software installed or a computer turned on to make copies. You can adjust copy settings at the control panel. Originals can be copied using either the ADF or the scanner. Copy, print, and send jobs can be processed simultaneously.

The topics in this section include the following:

- using the system defaults
- using one-touch copying
- using the Describe Original and Copy Settings screens
- duplexing a copy job

It is helpful to review the chapter entitled [“Control panel and control panel menus” on page 33](#) before using the copying functions. For information about changing the default copy settings, see the [“System administrator guide” on page 137](#).



Performing basic copying

Copy defaults

The preset default copy settings for the HP LaserJet 4100 mfp series are:

- single-copy output
- letter-sized original and letter-sized copy (in North America only; otherwise, the default is A4)
- single-sided original and single-sided copy
- mixed text, and graphic photo document content
- normal brightness
- no reduction or enlargement (100%)
- one page per sheet (1-up) copying



One-touch copying

If you wish to make a single copy using the product's default settings, place your document in the ADF or on the scanner glass and press **START**.

Multiple copies

To make multiple copies, use the numeric keypad to type the desired number of copies (1 to 99), and then press **START**.



User-defined copy settings

To make copies at settings other than the system defaults, navigate through the Describe Original and Copy Settings screens. The use of these screens is explained in the following sections.

Using the Describe Original screen

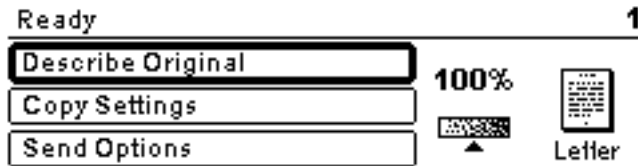

From the top-level screen, enter the Describe Original screen by clicking Describe Original and then pressing the ✓ button.

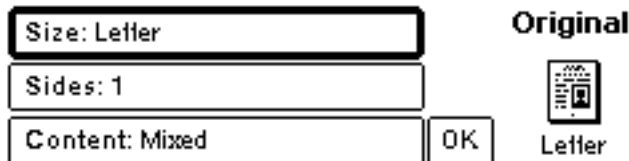

To change the description of your original, use the up and down navigation buttons to move through the Describe Original screen to the desired setting box. Confirm your choices by pressing ✓ when the correct setting is highlighted.

- 1 Place the original in the ADF or on the scanner glass.
- 2 While in the Describe Original screen, press ✓ to view options.

Note

If the original is Letter-size or A4-size and you plan to use the copier defaults, simply press **START** to make a copy.

- 3 Review the options by using the navigation buttons and select the items that describe your original by pressing ✓. The options are:
 - **Size:** select **Letter, Legal, Executive, A4, A5, or B5**
 - **Sides:** select **1 or 2**
 - **Content:** select **Text, Mixed or Photo**
- 4 When you have made your selections, navigate to and click **OK**. This returns you to the top-level screen.



Note

Changes made are reflected in the “original” graphic.



Using the Copy Settings screen

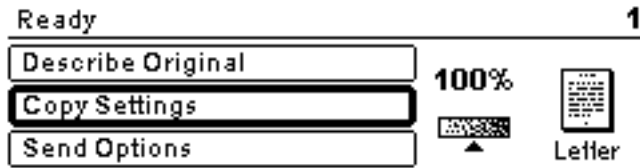

Use the Copy Settings screen to select the options for the copies to be made if one-touch copying is not used. This screen allows you to scroll through various options, pressing ✓ to select features. Additional copy features are available through the Copy and Send menus.

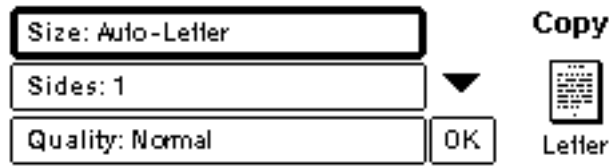

- 1 Navigate to the Copy Settings screen and press ✓. Scroll downward through the menu options to select the characteristics of the copies to be made. Available options include the following:
 - **Size:** media sizes available for selection depend on the sizes of the media that is actually loaded into the trays, since the MFP senses media sizes when the trays are loaded. Scroll through the list to select from the following:
 - Auto-Letter
 - Letter-Manual Feed
 - Legal - Tray 1
 - Letter - Tray 2
 - Legal, Executive, A4, A5, or JISB5

Note

Auto means that the output size will match the size of the original. When you select Auto-Letter, your Letter-sized original will be copied to Letter-sized media.

- **Scale to Fit:** source document contents are adjusted to fit the selected media output size.

Note

Other media sizes are listed, but a tray must be loaded with these media sizes for them to be used.

- **Sides:** choose whether input is printed single or double-sided. For further information, see [“Duplexing a copy job” on page 47](#).
 - 1
 - 2 - Normal
 - 2 - Flipped

Note

If you select **2 - Normal** in the **Sides** setting option in the Copy Settings screen, the back side of the two-sided page is printed right-side up. If you select the **2 - Flipped** option, the back-side image is printed upside down relative to the front-side image.

- **Quality:** select output quality of an image. “Best” optimizes the output quality.
 - Normal
 - Best

Note

If you select **Best**, scanning speed will be somewhat slower than when operating in **Normal** mode.

- **Pages per sheet:** select the number of originals pages on each output sheet.
 - **1** (one sheet per page, with no border)
 - **2 or 2 Borders** (two sheets per page, without or with borders)
 - **4 or 4 Borders** (four sheets per page, without or with borders)
- **Background:** allows removal of shading when copying an original with a colored background, or removal of bleedthrough from the second side of a two-sided original. Using the right or left navigation buttons, slide the slider bar to the desired setting.
- **Collate:** allows printing multiple copies in sets or page number groupings. For example, if you are making two collated copies of a three-page document, the copies print in this order: 1,2,3; 1,2,3. Collate is the default for this MFP.
 - **Collate** (123, 123, 123)
 - **Uncollate** (111, 222, 333)



- 2 When you are finished, navigate to and click **OK** and press ✓.
- 3 Make any necessary adjustments to the contrast using the light/dark buttons and enlarge/reduce buttons at the right-hand side of the control panel to zoom in one-degree increments.
- 4 Use the numeric keypad to indicate the desired number of copies, and then press **START**.

Note

The Copy Settings screen shows an image that represents modifications made to achieve the desired output.

Duplexing a copy job

Any copy job can be duplexed. See “[Duplex copying and printing](#)” on page 29 for general information. These duplexing options are available:

- One side to two sides. If a duplexer is installed and you are using the ADF, this duplexing is done automatically. If you are using the scanner glass, you are prompted to place the next original on the glass.
- Two sides to one side. When this option is selected, you are prompted to turn the page over to copy the second side. Either the scanner glass or the ADF can be used. A duplexer is not required.
- Two sides to two sides. This option requires that a duplexer be installed. When you select this option, you are prompted to turn the originals over to copy the second side whether you are using the ADF or the scanner glass.



Note

When copying two sides to two sides, the MFP scans each page and stores the page images on the hard disk until both sides of each original have been scanned and placed into the correct order. For this reason, you will experience a slight delay before the copy job starts to print. After copying begins, output will be at normal speed.

Adjusting the contrast

Press the light/dark buttons on the right side of the control panel to lighten or darken your copies. After your copies are made, the contrast setting returns to the default setting.

Improving copy quality

When you establish your copy parameters on the Copy Settings screen, select **Best** from the **Quality** options.

You can also modify the copy quality with the **Content** option on the Describe Original screen. The default setting is **Mixed**. When copying a photograph or graphic, you can select **Photo** to improve copy quality, or select **Text** for a document that contains only text.



Reducing or enlarging copies

By using the enlarge/reduce buttons on the right side of the control panel, you can reduce copies to 25 percent of the original size or enlarge them up to 400 percent (up to 200 percent from the ADF), in one-percent increments. Also, if you specify a standard sized document on the Describe Original screen and a different standard size on the Copy Settings screen, the image will be scaled automatically.

Note

The HP LaserJet 4100 mfp series printer has reduce/enlarge presets for standard media sizes. For example, if a Legal sized original is copied onto a Letter sized paper, the image is automatically reduced to fit. Likewise, an A5 original is enlarged to fit on A4 media.



5 Sending to e-mail

Overview

The HP LaserJet 4100 mfp series can scan documents to any e-mail address.

Note

The MFP can send color images, although it cannot copy or print in color.

The following topics are addressed in this chapter:

- introduction
- sending documents
- available file formats
- using and managing address books

Introduction

Send to email (part of the Digital-sending suite) is similar to faxing information, but offers these advantages:

- sends mail to multiple e-mail addresses simultaneously, saving time and delivery costs
- ensures privacy by sending information directly to e-mail in-boxes rather than to a fax machine, which might have many users
- delivers files at near-original quality in black and white or in color
- sends files in JPEG, PDF, and TIFF file formats, which can be modified by the recipient in computer programs

Documents are scanned and sent as attachments to an e-mail address. Digital documents can be sent in the formats shown above, enabling recipients to manipulate the document in various programs to meet their specific needs. The e-mailed document can be printed for your records.

By using HP Smart Compression technology, digital-sending keeps file sizes small, minimizing the impact on the network. Documents arrive in near-original quality. Like other e-mail messages, the documents can be printed, stored, or forwarded.

The HP LaserJet 4100 mfp series connects directly to the LAN, so that you can send digital documents without a dedicated computer. E-mail processing is done entirely within the product, from scanning through communicating with the network SMTP gateway. E-mail addresses can be acquired from an at-device address book or an LDAP server. The system administrator can configure e-mail parameters either over the network using the embedded Web server or HP Web JetAdmin, or at the control panel.



Sending documents

You can use the digital-sending feature with either the scanner glass or the ADF.

Note

When using the scanner glass, place the original face down. When using the ADF, place the originals face up. Irregular, worn, or previously folded documents, as well as photographs, should be scanned using the scanner glass.



Describe Original screen

If necessary, describe your original before entering the Send Options screen.



Send Options screen

The Send Options screen on the control panel display allows you to describe parameters for sending a document to an e-mail address.

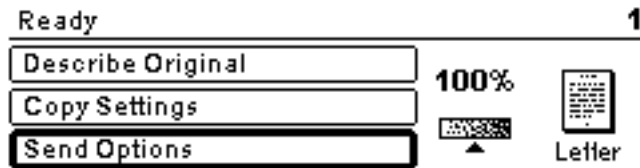

Basic sending procedures

Using the address books

Use the control panel keyboard to type data into the **From:**, **To:**, **CC:**, or **Subject:** fields. As you begin to type e-mail addresses, the MFP automatically searches the address book and displays the first matching name or address. You can select that name, or continue to type the name until auto-complete finds the correct entry. You can also scroll through the name listings to locate the desired names.



Note

If a recipient's e-mail address is not recognized, you will be asked if you wish to add the entry to the local address book.



Sending a document

To digitally send a document:

- 1 Place your original document face-down on the scanner glass or face-up in the ADF.
- 2 If your original matches the default settings (mixed text and photo, default media size, standard resolution, single-sided), proceed to step 3. Otherwise, use the control panel display to describe the document by using the Describe Original screen.
- 3 On the control panel display, select **Send Options**.
- 4 In the main Send Options screen, select **E-mail**.

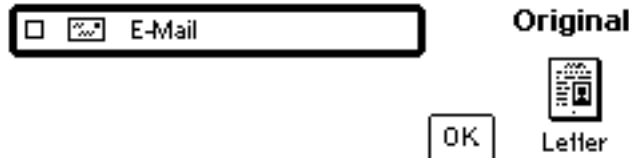

- 5 Using the keyboard, type your e-mail address in the **From:** field.

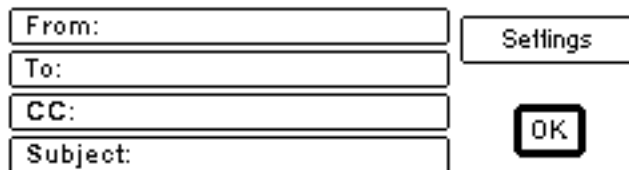

- 6 Type the addresses of the recipient(s), or select the addressees from the address book. Press ✓ to add the names to the recipient list. Navigate to **OK** and press ✓. The main e-mail screen appears.

Note

You can review and edit the recipient list using the View List option, shown below.



- 7 Using the same method, enter the names of any **CC:** (copy) recipients, and type the subject of the e-mail.
- 8 Navigate to the **Settings** field. Here you can select document parameters from the following:
 - **Color:** **Black and white (B/W)** or **Color**
 - **File type:** **PDF, TIFF, M-TIFF,** or **JPEG**



Note

See [“Available file formats” on page 52](#).

- 9 Make your selections, navigate to **OK**, and press ✓. You then return to the e-mail screen.

10 Press **START**. When the file is being sent, you receive the following message:

PROCESSING DIGITAL SEND JOB

Note

Press **RESET** at any time to cancel the e-mail settings and return to the top-level screen. You can also press **STOP** to terminate the sending operation.

11 When sending is complete, remove the original document from the scanner glass or the ADF.

Sending a two-sided document

To send a two-sided document successfully, make sure you describe the original as a two-sided document on the Describe Original screen. After scanning the page on the scanner glass or scanning the stack of originals in the ADF, the MFP prompts you to turn over the originals so the second side can be scanned and ordered correctly before the file is sent.



Available file formats

Select **Settings** in the e-mail screen to designate color and file type options for the document to be sent.

In the **Color** option, you can select:

- color
- black and white (B/W)

By using the **File** option, you can select any of these file formats:

- **PDF**: the default setting, which renders the best overall text and graphic quality. These files are viewed through Acrobat Reader. The attached file will have a .pdf extension.
- **JPEG**: best for viewing through an Internet browser. The attached file will have a .jpeg extension.
- **TIFF**: a standard file type that works well with many programs. The attached file will have a .tif extension.
- **M-TIFF (multipage TIFF)**: this format compresses a multi-page document into a compact, single-file format. The attached file will have a .tif extension.

Note

The format for the file to be sent is selected in the Send Options screens.

Documents that are sent as JPEG or TIFF files can be brought into various software programs and modified by the recipient. The recipient must have Acrobat Reader installed to read PDF files.



Address books

The HP LaserJet 4100 mfp series can use your network e-mail server's address lists (LDAP), and can also develop a local address book. Your network address list is automatically configured for use during initial product configuration. After configuration, the list can be used to select e-mail recipients when digitally sending documents. E-mail addresses that are not resident in the network address book can be added to the local address book for future use.

See ["System administrator guide" on page 137](#) for more information about address list configuration.





6 Network printing

Overview

When the HP LaserJet 4100 mfp series printer drivers are installed on your computer, the product can function as a network printer, and you can send print jobs from any software program. This chapter addresses these advanced printing tasks:

- installing the printer software
- using features in the printer driver
- customizing trays for printing or copying
- using job-storage features
- printing with the FIR port

See ["Basic operations" on page 19](#) for additional information about printing. Other chapters of this guide address copying and digital-sending capabilities and procedures.



Installing the printer software

The HP LaserJet 4100 mfp series comes with complete printer installation software on a CD-ROM. If you plan to use the product as a network printer, install the printer drivers on each computer that will send documents for printing. If your computer does not have a CD-ROM drive, but you have access to one, you can copy the software onto disks for installation on the computer. See the *start* guide for software installation instructions.

The printer drivers must be installed to take full advantage of printer features. Installation of other software programs on the CD-ROM is recommended, but is not required. See the Readme.wri file for more information.



Note

Check the Readme.txt file provided on the CD-ROM for late-breaking product information.

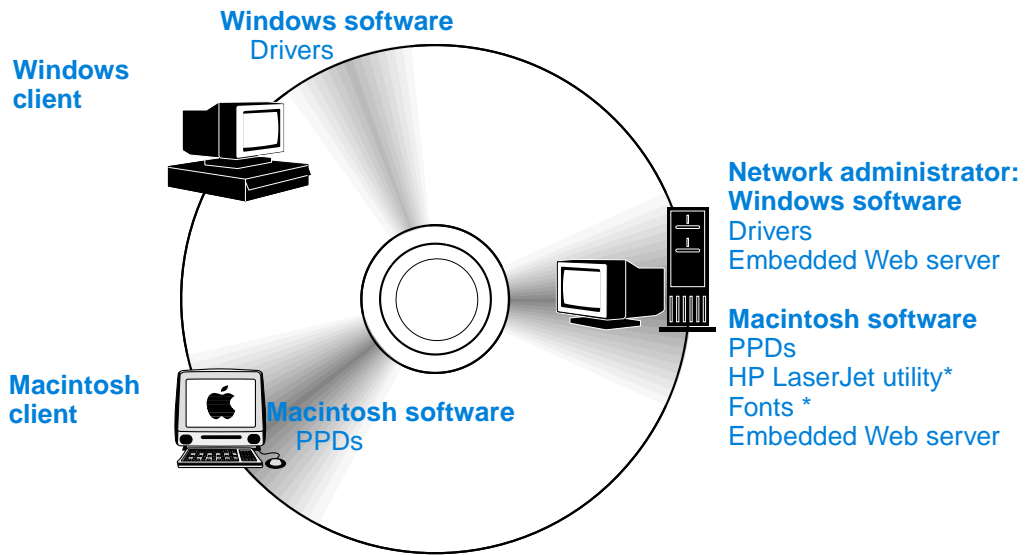

* Not supported for Czech, Korean, Japanese, Russian, Simplified Chinese, Traditional Chinese, and Turkish.

If your Windows-based computer has Internet access, the installation program automatically checks for the availability of the latest software from the HP web site. If you do not have access to the Internet, see [“HP customer care service and support”](#) on [page 107](#) for information about obtaining the most recent software.



HP LaserJet printing system

The CD-ROM contains software components and drivers for both end-users and network administrators who are using the operating systems listed here. See the Readme.wri file for the most current information.

- Microsoft Windows 95 and 98
- Microsoft Windows Me
- Microsoft Windows NT® 4.0
- Microsoft Windows 2000
- Microsoft Windows XP
- Apple Macintosh OS, version 7.5.3 or higher
- AutoCAD™ drivers, versions 12 through 15

Drivers and documentation for Windows NT 3.51 are available on the Internet. Drivers, the font installer, and documentation for Windows 3.1x are available on the CD-ROM that comes with the product.



Printer drivers

Printer drivers allow you to gain access to the printer features and allow networked computers to communicate with the printing services using a printer language.

Note

Check the Readme.wri file provided on the CD-ROM for additional software included and languages supported.

Certain printer features are available only with the PCL 6 drivers. See the printer software Help for availability of features.

The printer drivers listed in the following table are included with the printer. The most recent drivers are available at <http://www.hp.com/support/lj4100mfp>. When the printer software is installed on some Windows-driven computers, the program automatically checks the computer for Internet access to obtain the latest drivers.

Operating system	PCL 5e	PCL 6	PS ¹	PPDs
Windows 3.1x	●	●	● ²	
Windows 95 and 98 Windows Me	●	●	●	●
Windows NT 4.0	●	●	●	●
Windows 2000 Windows XP	●	●	●	●
Macintosh OS				●

1. PostScript 3 emulation is referred to as PS throughout this guide.

2. Level 1 emulation only.

You can obtain the following printer drivers by downloading them from the Internet, or by requesting them from an HP-authorized service or support provider (see “[HP customer care service and support](#)” on page 107).

- Windows NT 3.51 PCL 5e and Windows NT 3.51 PS (available for English only)
- UNIX and Linux model scripts

OS/2 drivers are available from IBM and are packaged with OS/2. They are not available for the Japanese, Korean, Simplified Chinese, and Traditional Chinese languages.

Note

If the desired printer driver is not on the CD-ROM or is not listed here, check the software program’s installation disks or the Readme.txt files to see if the program includes support for the printer. If it does not, contact the software manufacturer or distributor to request a driver for the printer.



Software for Windows-based computers

Note

The following information is required only if the product is to be used as a network printer.

Reaching the Windows printer driver

To configure the driver, reach it in one of the following ways:

Operating system	Temporarily change settings (from a software program)	Change default settings (across all programs)
Windows 95 and 98 Windows Me	On the File menu, click Print , and then click Properties . (The actual steps can vary. This is the most common method.)	Click the Start button, point to Settings , and then click Printers . Right-click the Printer icon, and then click Properties .
Windows NT 4.0	On the File menu, click Print , and then click Properties . (The actual steps can vary. This is the most common method.)	Click the Start button, point to Settings , and then click Printers . Right-click and then click Document Defaults or Properties .
Windows 2000 Windows XP	On the File menu, click Print , and then click Properties . (The actual steps can vary. This is the most common method.)	Click the Start button, point to Settings , and then click Printers . Right-click and then click Printing Preferences or Properties .
Windows 3.1x and Windows NT 3.51	On the File menu, click Print , click Printers , and then click Options . (The actual steps can vary. This is the most common method.)	On the Windows control panel, double-click Printers , highlight the printer, and click Setup .



Note

The default product settings are established or modified by the system administrator. The user can override these defaults from the control panel or the software program for the current job only. Software program settings override printer driver settings.

Choosing the appropriate printer driver

Choose a printer driver based on the way you plan to use the MFP's printing features.

- Use the PCL 6 driver to take full advantage of printing features. The PCL 6 driver is recommended unless backward compatibility with previous PCL drivers or older printers is necessary.
- Use the PCL 5e driver if you want printed output to resemble older printers, or for font DIMM support.
- Use the PS driver for compatibility with PS 3. Certain features are not available in this driver.



If all drivers are installed, the printer automatically switches between PS and PCL printer languages.

Printer driver Help

Each printer driver has Help screens that can be activated from the Help button, the F1 key, or the question mark symbol on the upper-right corner of the printer driver screen (depending on the Windows operating system used). Reach the printer driver screen by clicking **Print** from your software program. These Help screens give detailed information about the specific driver. The printer driver Help is separate from the software-program Help.

Software for Macintosh computers



PostScript Printer Description files

The PPDs, in combination with the Apple LaserWriter 8 driver, provide access to the product features and allow a networked computer to communicate with the printer. An installation program for the PPDs and other software is provided on the CD-ROM. Use the Apple LaserWriter 8 driver that came with your Macintosh computer.



HP LaserJet utility

The HP LaserJet utility allows you to control printing features that are not available in the printer driver. The illustrated screens make selecting printer features when using the Macintosh computer easy. Use the HP LaserJet utility to do the following:

- customize product control panel messages
- name the product, assign it to a zone on the network, download files and fonts, and change most of the settings
- set a password for the product
- from the computer, lock out functions on the control panel to prevent unauthorized access (see the printer software Help)
- configure and set the product for Internet protocol (IP) printing

Note

The HP LaserJet utility is not supported for the Czech, Korean, Japanese, Russian, Simplified Chinese, Traditional Chinese, or Turkish languages.

Software for networks

For a summary of available HP network installation and configuration software solutions, see the *HP Jetdirect Print Server Administrator's Guide*. You can find this guide on the CD-ROM included with the product.

HP Web JetAdmin

The HP LaserJet 4100 mfp series is fully supported by HP Web JetAdmin, a browser-based management tool typically installed on a network to manage multiple printers. This tool is intended for use by the system administrator. Small networked workgroups generally do not require HP Web JetAdmin, but if you administer a large enterprise, you can easily download this product from the Internet at <http://www.hp.com/go/webjetadmin>.



Note

For the latest list of supported host systems, visit HP Customer Care online at <http://www.hp.com/go/webjetadmin>.

For additional information about using HP Web JetAdmin in a large enterprise, see “System administrator guide” on page 137.

UNIX and Linux

Note

The HP Jetdirect printer installer for UNIX and Linux is a printer installation utility for HP-UX and Solaris networks. It is available for download from HP Customer Care online at http://www.hp.com/support/net_printing.

Performing advanced printing tasks



Using features in the printer driver

When you print from a software program, many of the MFP features are available from the printer driver. See “Printer drivers” on page 58.



Note

Certain product features might not be available with all drivers. Check the drivers for available options.



Settings in the printer driver and software program generally override control panel settings. Software program settings generally override printer driver settings.

See the software program or printer driver Help for specific steps.

Printer collation

The printer collation feature allows you to print multiple originals. This offers the following advantages:

- reduced network traffic
- faster return to program
- all documents are originals

RIP ONCE

RIP ONCE allows a print job to be processed one time at the printer. The RIP ONCE capability creates an image of the page and then saves a compressed image of the page into memory. Pages are printed by decompressing page images without pausing to process the print job again. The print job will print exactly the same every time because the compressed image is not dependent on any other printer data.

Saving printer setup information (Quick Sets)

The Windows PCL 6 and PCL 5e printer drivers allow you to save specific printer settings as defaults for various types of standard print jobs. For example, you might want to create a Quick Set for printing envelopes, or for printing the first page of a document on letterhead.



Scaling page image (ZoomSmart)

The Windows PCL 6 and PCL 5e printer drivers include a feature called ZoomSmart that allows you to scale the page image from any page size to any other page size. You can do this either by a numeric percentage or by specifying a different size scale.



Printing booklets

The Windows PCL 6 and PCL 5e printer drivers allow you to control booklet printing when duplexing. You have the choice of binding on the left or right side on letter, legal, or A4 paper.

Printing with a watermark

A watermark is a notice, such as “Draft” or “Top Secret”, that can be printed in the background of each page in a document. Watermarks are inserted into documents using the printer driver in the software program.

Printing a different first page

If you wish to print a first page that is different from the other pages in your print job, follow these instructions.

- 1 For Windows, select **Use different paper for first page** in your printer driver. Choose one tray (or **Manual Feed**) for the first page and an other tray for the remaining pages. Place the paper for the first page in Tray 1 (or whichever tray you selected). (For manual feed, place paper in Tray 1 after the job is sent to the printer and the printer requests paper.) When loading Tray 1, place the paper with the side to be printed face-up, with the top of the page toward the back of the product.

For Macintosh computers, select the **First from** and **Remaining from** options in the **Print** dialog box.



Note

Where and how you make these selections depends on your software program or associated printer driver. Some options might be available only through the printer driver.

- 2 Load the paper for the remaining pages of the document into another tray.

You can select the first and remaining pages by specifying the type of paper. For more information, see [“Manually feeding media from Tray 1” on page 64](#).

Inserting a blank back page

This option allows you to add blank pages to the end of a print job. In Windows, click **Use different paper for first page** in the **Paper** tab of the printer driver, and then click **Back page**. You can then select the paper source for the blank pages. To turn this feature off, click **No back page** in the printer driver.

Printing multiple pages on one sheet of media

You can print more than one page on a single sheet. This feature is available in the HP LaserJet 4100 mfp printer drivers, and provides a cost-effective way to print draft pages. This is sometimes called N-up printing.

Note

The PCL and PS drivers differ slightly in performance. Please review the options available in your printer driver.

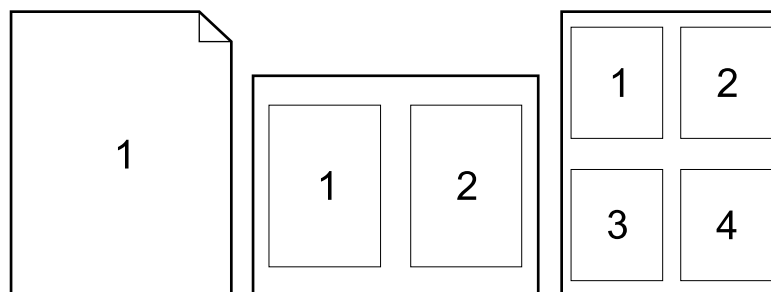

Customizing trays for printing or copying

Understanding tray order

When a print job is received, the MFP automatically selects an input tray by matching the requested media type and size to the media already loaded in the trays. If Tray 1 is loaded with media and set to `FIRST` mode in the Paper Handling menu, paper is always pulled from Tray 1 first.

If `TRAY 1 MODE=FIRST` is not selected, the product searches all available input trays for the media that satisfies the print request, starting with the bottom tray and ending with Tray 1. The job begins printing as soon as the proper type and size are found. If the search fails, a message appears on the control panel that asks you to load the correct media. You can then load the media, or you can override the request by requesting a different media type and size at the control panel. If a tray runs out of media during a print job, the product automatically switches to any tray that contains the same type and size of media.



Customizing Tray 1 operation

You can customize Tray 1 to meet your printing needs. The product can be set to print from Tray 1 when it is loaded, or to print only from Tray 1 if the type of media loaded is specifically requested. Set `TRAY 1 MODE=FIRST` or `TRAY1 MODE=CASSETTE` on the Paper Handling menu at the control panel.

Setting	Explanation
<code>TRAY 1 MODE=FIRST</code>	The printer will usually pull paper from Tray 1 first unless it is empty or locked. If you do not keep media in Tray 1 all the time, or if you use Tray 1 only for manually feeding paper, keep the default setting of <code>TRAY 1 MODE=FIRST</code> on the Paper Handling menu.
<code>TRAY 1 MODE= CASSETTE</code>	Tray 1 operates like Trays 2, 3, and 4. Instead of looking first for paper in Tray 1, the MFP pulls paper from the tray that matches the selected type and size settings. When <code>TRAY 1 MODE=CASSETTE</code> is set, an option appears on the Paper Handling menu to configure size as well as type settings for Tray 1.

Specifying type and size of media (locking trays)

You can configure the MFP to select media by type (such as plain or letterhead) and size (such as letter or A4), as opposed to source (a paper tray). See [“Supported paper sizes and weights” on page 114](#).

Printing by type and size of media ensures that print jobs always print on the desired media. If you frequently use several kinds of media, you can set up trays so that you do not have to check which media is loaded in each tray before you print. This is especially helpful when the product is shared and more than one person loads or removes media.



Note

For networked products, the type and size settings can also be configured from the embedded Web server or HP Web JetAdmin software. See the product software Help for more information.



To print by type and size of media

- 1 Load the trays correctly and adjust the paper guides.
- 2 Select the `TRAY 1 TYPE` option on the Paper Handling menu on the control panel and specify the type of media for each tray. If you are unsure of the media type (such as bond or recycled paper), check the package label.
- 3 Select the size settings on the control panel.
 - Tray 1: If `TRAY 1 MODE=CASSETTE` is selected on the Paper Handling menu, specify the size on the menu. If custom media is loaded, set the size of custom media on the Printing menu to match the media loaded in Tray 1.
 - Trays 2, 3, and 4: The media size is automatically detected when media is properly loaded into the tray and the paper guides are adjusted to match the media size. If custom media is loaded, set the size of custom media on the Printing menu to match the media loaded in the tray. Set the media size slider in the tray to Custom.



Note

To print custom-size media, [“Guidelines for using custom paper” on page 28](#).

- Optional power envelope feeder: Set the media size on the Paper Handling menu.

- 4 From the software or printer driver, select the desired type and size of media.

Note

The type and size settings can also be configured from the embedded Web server or HP Web JetAdmin software for networked products. See the printer driver Help for information about this option.

To print by media type and size, it might be necessary to unload or close Tray 1, or to set `TRAY 1 MODE=CASSETTE` on the Paper Handling menu on the control panel. For more information, see [“Customizing Tray 1 operation” on page 63](#).

Settings in the printer driver and software program override the control panel settings. Software program settings generally override printer driver settings.

Manually feeding media from Tray 1

The manual feed feature is another way to print on special media. If you set this feature to **On** at the control panel or the printer driver, printing stops after each job is sent, allowing you time to load special media in Tray 1. Press **START** to resume printing.

If Tray 1 already contains media when you send the print job and the control panel shows `TRAY 1=FIRST` as the default configuration, the product will *not* stop and wait for the special media to be loaded. To use the manual media loading feature, set `TRAY 1=CASSETTE` on the Paper Handling menu (see [“Customizing Tray 1 operation” on page 63](#)).

If you have selected `MANUAL FEED=ON` on the control panel, this setting will override the printer driver, and all print jobs sent to the product will request that you manually feed media from Tray 1 unless a specific tray is selected from the printer driver. If this feature is to be used only occasionally, it is best to set `MANUAL FEED=OFF` on the control panel.



Using the job-storage features

The HP LaserJet 4100 mfp series offers several job-storage features that allow you to retain print jobs in memory for later use. You create stored jobs through the printer driver when you use a software program.

Use the **MENU** button on the control panel to retrieve and print jobs. All stored jobs are stored in the **RETRIEVE JOB** menu, and are listed in order of user name. Quick Copy, proof-and-hold, private, and stored jobs sent from the computer are listed on this menu.

Each job type is described below.

- **Stored jobs:** This feature allows you to store a print job, such as a personnel form or report, permanently on the hard disk to be printed when it is needed. The job can be printed at any time using the **RETRIEVE JOB** menu on the control panel.
- **Private jobs:** This feature allows you to prevent a job from printing until an assigned PIN is typed at the control panel. Private jobs are automatically deleted from the hard disk after they are released for printing. You can also select and delete a private job without printing it.
- **Quick Copy jobs:** This feature allows you to print the required number of copies and store the job on the hard disk for later printing.
- **Proof and hold jobs:** This feature provides a quick and easy way to print and proof one copy of a job and later print the additional copies.



Note

If you turn the MFP off, all Quick Copy, proof and hold, and private jobs are deleted. A Quick Copy job can also be deleted by using the product software or through HP Web JetAdmin. To make sure that a job is not deleted when the product is turned off, save it as a stored job.

Reaching the job storage features

For Windows

- 1 On the **File** menu within the software program, click **Print**.
- 2 Click **Properties** and then click the **Destination** tab.
- 3 Under **Destination Features**, click **Options** to show the **Job Storage Options**.
- 4 Select the desired job type and assign the job a unique name.

For Macintosh

In newer drivers, select **Job Storage** on the pull-down menu in the **Print** dialog box. In older drivers, select **Printer Specific Options**.

CAUTION

Make sure to assign unique names to your jobs using the printer driver before printing. Using default names might override previous jobs with the same default name or cause the job to be deleted.



Printing stored jobs

To print a stored job through the control panel:

- 1 Press **MENU** and select the **RETRIEVE JOB** menu.
- 2 Use the Up or Down navigation arrows to highlight the desired user name and press **✓**.
- 3 Again, use the Up or Down navigation arrows to select the desired job name and press **✓**.

Note

If a **Lock** icon appears beside the job name, the job is private and you must enter the correct PIN to print it.

- 4 Use the keypad to type the number of copies.
- 5 Press **START** to print the job.

Deleting stored jobs

Stored jobs remain on the hard disk until they are deleted. To delete a stored job, use this procedure.

- 1 Press **MENU** and select the **RETRIEVE JOB** menu.
- 2 Use the up and down navigation keys to select the desired user name and job name.
- 3 Press **✓** to select the job.
- 4 Select **DELETE** and press **✓** to delete the job.



Printing with the FIR port

The optional FIR port enables wireless printing to the product from any portable device (such as a laptop computer) that is compliant with IrDA (Infrared Data Association) standards.

The printing connection is maintained by positioning the sending FIR port within operating range. Note that the connection can be blocked by objects such as a hand, media, direct sunlight, or any bright light shining into the sending or receiving FIR port.



Note

For more information, see the user guide that came with the FIR port. If you do not have infrared software installed, contact your computer manufacturer for drivers and installation instructions.



Preparing to print with Windows

Before launching the infrared driver, complete the following steps:

- 1 In the Windows toolbar, select **Start**, click **Settings**, and then click **Printers**.
- 2 Select the HP LaserJet 4100 mfp as your default printer.
- 3 While in the Printers folder, choose **Properties/Details**, and specify the Virtual Infrared LPT Port.
- 4 Select the file to print.



Preparing to print with Macintosh computers

The first step for setting up an infrared printer is creating a **Desktop Printer** icon by using the Desktop Printer Utility. By default, the Desktop Printer Utility is located in the Apple Extras/Apple LaserWriter folder on the hard drive.

Printer IR is not an option if the infrared control panel and extensions are not active. In addition, the infrared print capability is possible only with HP LaserWriter version 8.6 driver or later.

- 1 Launch the Desktop Utility.
- 2 Select **Printer IR (Infrared)** and click **OK**.
- 3 Change **PostScript Printer Description (PPD) File** to match the product.
- 4 On the **File** menu, click **Save**.
- 5 Enter a name and location for the **Desktop Printer** icon and click **OK**.

Note

When the icon is on the desktop (or saved elsewhere), product options need to be manually configured. This step is similar to selecting **Configure** after setting up a printer in the Chooser. To set the options, highlight the **Desktop Printer** icon and select **Change Setup** on the **Printing** menu.



Printing a job using FIR

- 1 Align your laptop computer (or other portable device equipped with an IrDA-compliant FIR window) within 1 meter (3 feet) of the FIR receiver. The FIR window must be at an angle within ± 15 degrees relative to the product to ensure an effective connection for printing.
- 2 Print the job. The status indicator on the HP FIR receiver lights up, and, after a short delay, the control panel shows `PROCESSING JOB`.

If the status indicator does not light up, realign the receiver with the FIR port on the sending device, resend the print job, and maintain the alignment of all devices. If you have to move the equipment (for example, to add media), make sure that all devices remain within the range of operation to maintain the connection.

If the connection is interrupted before your print job is complete, the FIR port status indicator turns off. You have up to 40 seconds to correct the interruption and continue the job. If the connection is resumed within this time, the status indicator lights up again.



Note

The connection is permanently broken if the sending port is moved out of operating range or if anything passing between the ports blocks transmission for more than 40 seconds. Depending on the size of the job, printing with the FIR port might be slower than printing with a cable connected directly to the parallel port.

Interrupting and resuming FIR printing

The job interrupt and resume feature allows you to temporarily stop the job that is currently printing to print another job through an FIR port. When the FIR job is finished printing, the interrupted job resumes printing.

To interrupt the job at the product control panel, connect to the FIR port on the product and send a job to be printed. The product stops printing the current job when it reaches the end of the copy it is printing. The product then prints the job sent through the FIR port. When the FIR job is complete, the product resumes printing the original job where it had stopped.



7 Product maintenance

Overview

This chapter explains basic product maintenance procedures for the HP LaserJet 4100 mfp series. These include:

- managing the toner cartridge
- cleaning the product
- performing preventative maintenance

CAUTION

Turn the main power-switch off and unplug the MFP before you disconnect any cables or accessories, and before you perform preventive maintenance or cleaning. If these activities are performed while the MFP is powered on and plugged in, serious product damage may result.



Managing the toner cartridge

HP toner cartridges

When you use an HP toner cartridge (part number C8061A or C8061X), you can obtain the following supplies information from the embedded Web server:

- amount of toner remaining
- estimated number of pages remaining
- number of pages printed
- other supplies information



Toner cartridge authentication

HP cannot recommend use of non-HP toner cartridges, either new or remanufactured. Because they are not HP products, HP cannot influence their design or control their quality. Service or repair required as a result of using a non-HP cartridge is *not* covered under the product warranty. When you use a non-HP toner cartridge, the printer cannot accurately report cartridge life.

The HP LaserJet 4100 mfp series warns you if a non-HP toner cartridge is inserted into the product. If you insert a used HP cartridge from another HP product, the MFP might have to print as many as 20 printed pages to verify that the cartridge is a genuine HP part.

Note

If you see a message stating that your toner cartridge is not genuine and you believe that you purchased a genuine HP cartridge, call the HP fraud hotline at (1) (887) 219-3183 (toll-free in North America).

Toner cartridge life expectancy

The life of the toner cartridge depends on the amount of toner that printing and copying jobs consume. When printing or copying text at 5 percent coverage, an HP toner cartridge lasts an average of 10,000 to 6,000 pages, depending on which cartridge is installed.

You can verify cartridge life through the:

- control panel (print the supplies status page).
- embedded Web server.
- HP Web JetAdmin.
- printer software.

Toner cartridge storage

Do not remove the toner cartridge from its package until you are ready to use it. The shelf life of a cartridge in an unopened package is approximately 2.5 years.



CAUTION

To prevent damage to the toner cartridge, do not expose it to light for more than a few minutes.

Toner low and toner out conditions

When toner is low, the control panel displays a **TONER LOW** message and the product continues to print. The message first appears when about 15 percent of the toner remains in the cartridge.

When the cartridge runs out of toner, the control panel displays a **TONER OUT** message and printing stops. You can continue printing the current job by pressing **START**. The message continues to appear for every job until you replace the toner cartridge.



Cleaning the product

General guidelines

Follow the cleaning procedure on the following page every time you change the toner cartridge or when print-quality problems occur. To minimize problems, keep the product free from dust and debris.

- Clean the outside of the product with a cloth dampened with water.
- Clean the inside of the product with a dry, lint-free cloth.

CAUTION

While cleaning the product, be careful not to touch the transfer roller (the black rubber roller located underneath the toner cartridge). Skin oils on the roller can affect print quality.

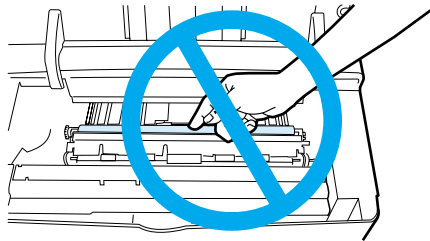

Cleaning procedure

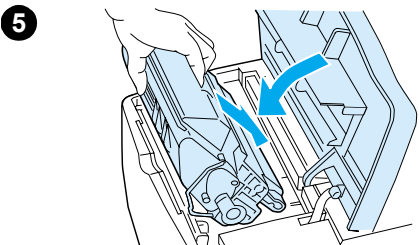
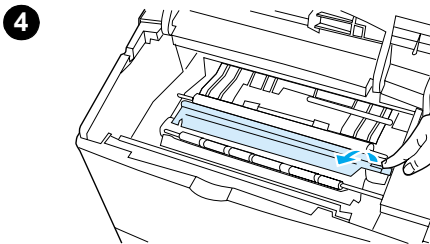
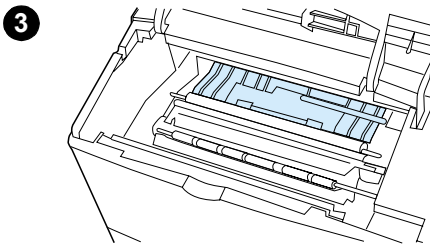
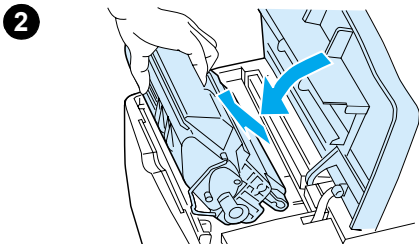
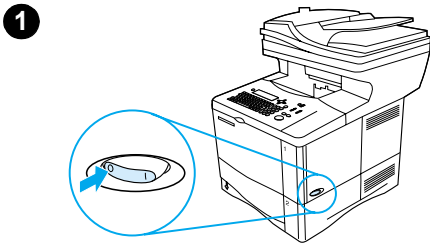

- 1 Turn the product off and unplug the power cord.
- 2 Open the top cover and remove the toner cartridge.

WARNING!

Avoid reaching too far into the printer. The adjacent fusing area might be hot. Wait half an hour until the fuser cools.



CAUTION

To prevent damage to the toner cartridge, do not expose it to light for more than a few minutes.



- 3 Wipe any dust or dirt off the paper-feed guides (shaded areas) with a dry, lint-free cloth.
-



Note

If toner gets on your clothing, wipe it off with a dry cloth and wash the clothing in cold water. (Hot water sets toner into fabric.)

- 4 Using the green handle, lift the paper-access plate and wipe off any residue with a dry, lint-free cloth.
- 5 Reinstall the toner cartridge, close the top cover, plug the power cord in, and turn the product on.



Cleaning the fuser

Run the cleaning page to keep the fuser free of toner and paper particles that can sometimes accumulate. Accumulation of toner and particles can cause specks to appear on the front or back side of your jobs (see “Specks” on page 97).

To ensure optimal output quality, HP recommends that you use the cleaning page every time you replace the toner cartridge or that you establish an automatic cleaning schedule.

You can run a cleaning page in two ways:

- manually as needed from the control panel display
- automatically at an interval that you establish



Note

The cleaning procedure takes about 2.5 minutes to complete. A message on the control panel display appears while the cleaning is taking place (either PROCESSING CLEANING PAGE or PROCESSING AUTO CLEANING PAGE).

Running the cleaning page manually

To ensure that the cleaning page works properly, print the page on copier-grade paper (not bond, heavy, or rough paper).

To run the cleaning page manually:

- 1 At the control panel, press **MENU** until the PRINT QUALITY menu appears.
- 2 Press **ITEM** until CREATE CLEANING PAGE appears.
- 3 Press **SELECT** to create the cleaning page. A page with a black stripe prints.
- 4 Follow the instructions on the cleaning page to complete the cleaning process.

Running the cleaning page automatically

Using the following procedure, you can automatically print cleaning pages at any interval that you choose. To allow the cleaning page to run without intervention, you must keep the selected size and the plain paper available in the printer. The product will not interrupt a printing job in process to print a cleaning page.

Discard the output page created by the automatic cleaning process.

To set the cleaning page to run automatically:

- 1 At the product control panel, press **MENU** until the PRINT QUALITY menu appears.
- 2 Press the Down navigation button until AUTO CLEANING PAGE=OFF appears.
- 3 Change OFF to ON and press ✓.
- 4 Press the Down navigation button until AUTO CLEANING FREQUENCY=2000 appears.



Note

The default frequency is every 2000 pages. To increase or decrease the frequency, press the Up or Down navigation buttons until you reach the desired frequency, and then press ✓. The options are 1,000, 2,000, 5,000, 10,000, and 20,000 pages.



- 5 Once you have selected the page frequency, press ✓ to save the choice.
- 6 Press the navigation buttons to select CLEANING PAGE SIZE=LETTER. You can choose to run the cleaning page on either letter or A4 paper. Use the navigation buttons to select either A4 or LETTER and then press ✓ to save your selection.

Cleaning the ADF paper delivery guide

- 1 Turn the power off.
- 2 Wipe the outside of the product with a dampened cloth.
- 3 Raise the ADF.
- 4 Open the delivery guide by pressing in the small plastic handles on either side of the delivery guide.

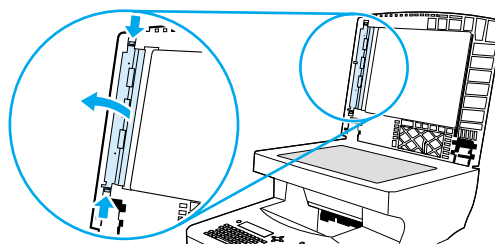

- 5 Remove the clear, plastic sheet.
- 6 Use a clean, soft, dry cloth to wipe the inside surface of the clear, plastic sheet.

CAUTION

Do not use water, liquid detergents, or solvents. Liquids might drip down into the mechanical parts and damage them.

- 7 Reinstall the clear, plastic sheet by sliding it under the gray ribbed guide, which is located under the white padded sheet.

Note

Make sure that the free end of the clear, plastic sheet is tucked behind the gray ribbed guide and the white padded sheet.

- 8 Align the holes in the sheet with the small plastic spindles in the delivery guide. Press the clear, plastic sheet down onto the spindles.
- 9 Close the delivery guide cover. You should hear the delivery guide cover plastic handles click into place.
- 10 Wipe the outside surface of the delivery guide with the cloth.



Cleaning the scanner glass

- Clean the glass only if dirt is visible, or if you are experiencing a decrease in copy quality (such as streaking).
- Clean the glass surface by wiping it gently with a clean, damp, lint-free cloth. Use an ammonia-based surface cleaner to dampen the cloth.

CAUTION

Do not pour or spray liquids directly onto the glass.

CAUTION

Do not press hard on the glass surface. You might break the glass.



Cleaning the calibration strip

- 1 Raise the ADF.
- 2 Locate the white, vinyl calibration strip. The calibration strip is to the left of the clear plastic sheet.

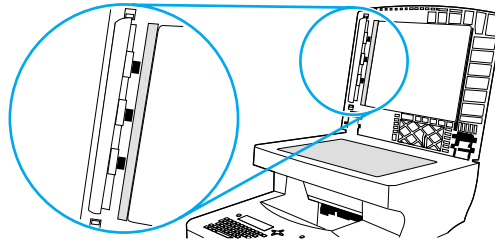

- 3 Clean the ADF backing and the calibration strip by wiping them with a clean, damp, lint-free cloth. Use an ammonia-based surface cleaner to dampen the cloth.
- 4 Close the ADF.



Performing preventative maintenance

You should replace certain parts when the `PERFORM PRINTER MAINTENANCE` message appears on the product control panel display. This helps ensure that the product maintains optimal performance.

The maintenance message will appear every 200,000 pages. To check the number of pages the product has printed, print either a configuration page or a supplies status page (see [“Reaching the embedded Web server” on page 139](#) for details).

To order the printer maintenance kit, see [“Ordering information” on page 125](#). The kit includes:

- fuser
- printer rollers (transfer, pickup, and feed)
- instructions

Note

The printer maintenance kit is a consumable item and is not covered under warranty.



8

Problem solving

Overview

This chapter will help you troubleshoot and solve problems that might occur while using the HP LaserJet 4100 mfp series.

Clearing jams

Occasionally, media might jam during copying and printing. This section helps you locate jams, properly clear them from the product, and solve repeated jams.

Understanding control panel error messages

Many of the messages that appear on the control panel are self-explanatory. However, some messages indicate a problem that requires intervention, or request further action. This section lists these messages and recommends corrective actions.

Correcting output quality problems

The product should produce high-quality jobs. If copy or print jobs do not look sharp and clear; if defects such as lines, specks, or smears appear on the page; or if media is wrinkled or curled; use this section to troubleshoot and solve the output quality problem.

Understanding error messages for the hard disk, FIR port, and PS

Additional messages are shown on the control panel to help you troubleshoot issues that involve the hard disk, the FIR port connection, and PS. This section lists these types of messages and recommends what to do.



Clearing jams

If the control panel display shows a jam message, look for media in the locations indicated in the figure on the next page, and then see the procedure for clearing the jam. You might need to look for media in locations other than those indicated in the jam message. If the location of the jam is not obvious, look first in the top cover area underneath the toner cartridge.

When clearing jams, be very careful not to tear the media. If a small piece of media remains in the product, it could cause additional jams. If jams are a recurring problem, see “Solving repeated jams” on page 85.



Note

The top cover of the product must be opened and then closed to clear a jam message.

If a jam occurs in the optional power envelope feeder, see the installation and use documentation that accompanied the product.

Jam locations

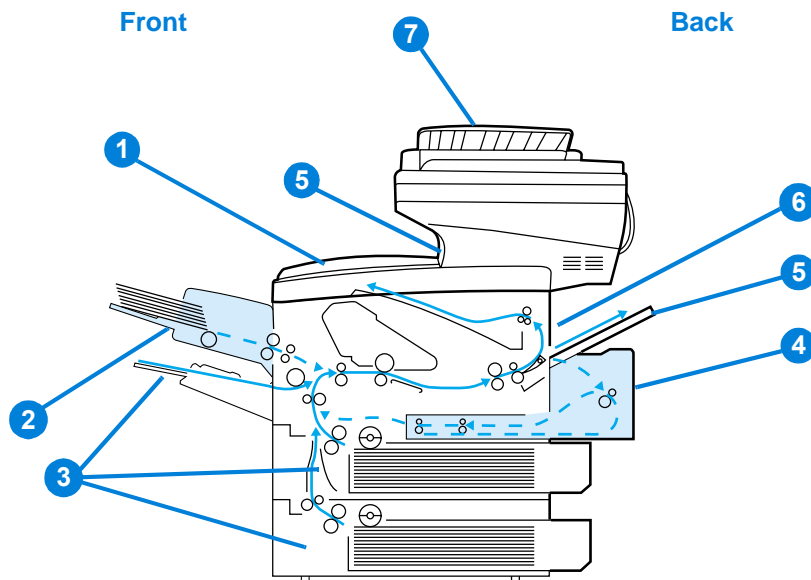

- 1 Top cover and toner cartridge area
- 2 Optional power envelope feeder
- 3 Input tray areas
- 4 Optional duplex printing accessory
- 5 Output bins (top and rear)
- 6 Fuser area
- 7 ADF



Note

Loose toner might remain in the product after a jam and cause output quality problems. These should clear up within a few pages.

Clearing jams from the top cover and toner cartridge area

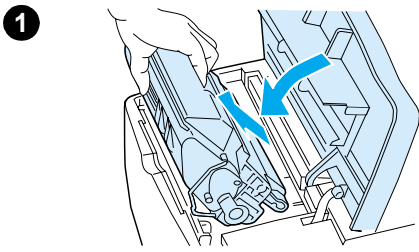

- 1 Open the top cover and remove the toner cartridge.

CAUTION

To prevent damage to the toner cartridge, do not expose it to light for more than a few minutes.

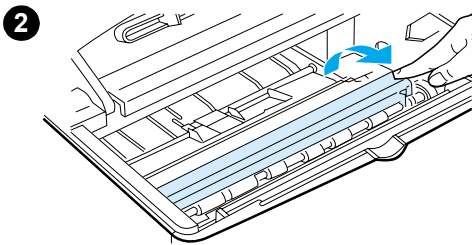

- 2 Use the green handle to lift the paper-access plate.

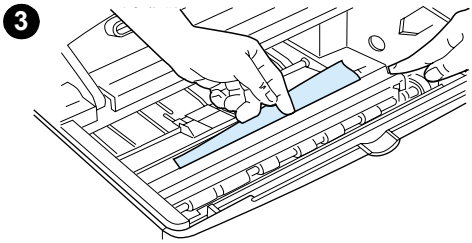

- 3 Slowly pull the media out of the product. Do not tear the media.

Note

If media is difficult to remove, try clearing it from the input tray area (see “Clearing jams from input trays” on page 80).

Avoid spilling loose toner. Using a dry, lint-free cloth, clean any loose toner that might have fallen into the product.

If loose toner falls into the product, it might cause temporary problems with print quality. Loose toner should clear from the paper path after a few pages are printed.

If toner gets on your clothing, wipe it off with a dry cloth and wash the clothing in cold water. (Hot water sets toner into fabric.)

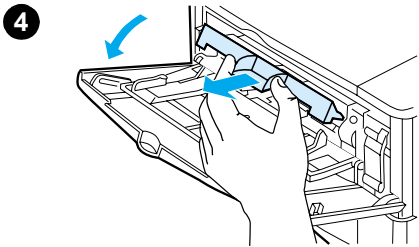

- 4 Open Tray 1 and remove the entrance cover to check for any additional jammed media. If any is present, remove it.

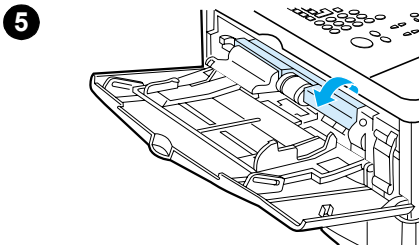

- 5 Rotate the paper guide to check for additional jammed media. If any is present, remove it.

Continued on the next page.



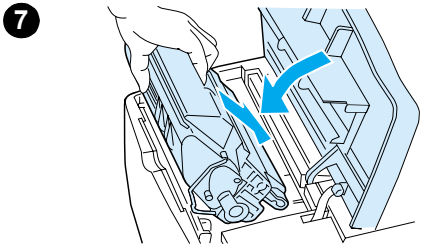
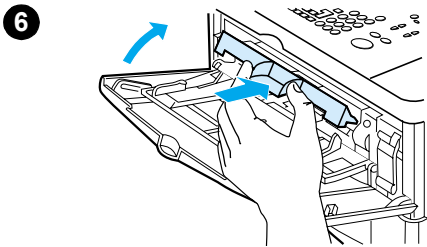

- 6 Replace the entrance cover and close Tray 1.
- 7 Reinstall the toner cartridge and close the top cover.
- 8 If a jam message persists, there is still media in the product. Look for media in another location (see [“Jam locations” on page 78](#)).

If you are using a non-HP toner cartridge, the message **NON HP TONER DETECTED** might appear on the control panel display. Press **START** to continue printing or copying.



Clearing jams from input trays

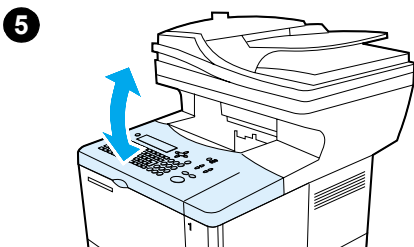
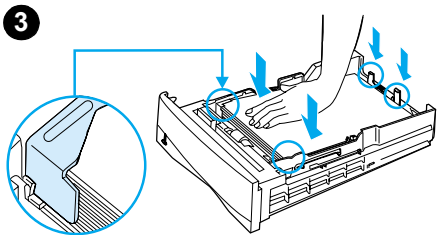
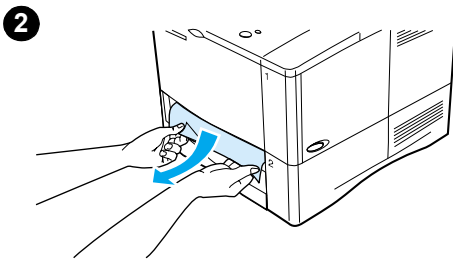
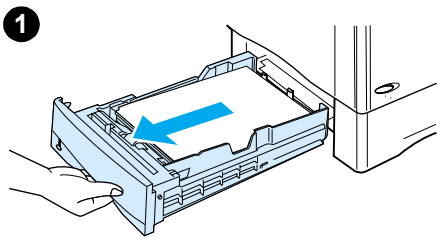

Tray 1

Slowly pull out the paper tray. If part of the media has already been pulled into the product, follow the steps under [“Clearing jams from the top cover and toner cartridge area” on page 79](#).

Trays 2, 3, and 4

- 1 Slide the tray out of the product, and remove any damaged media from the tray.
- 2 If the edge of the media is visible in the feed area, slowly pull the media down and out of the product. (Do not pull the media straight out or it will tear.) If media is not visible, look in the top cover area (see [“Clearing jams from the top cover and toner cartridge area” on page 79](#)).

Note

Do not force the media if it does not move easily. If the media is stuck in a tray, try removing it through the tray above or through the top cover area.

- 3 Make sure the media lies flat in the tray at all four corners and is tucked below the front and back tabs. Make sure that all three paper size adjustments are correct (see [“Loading Tray 2 and optional Trays 3 and 4” on page 24](#)).
- 4 Slide the tray back into the product.
- 5 Open and close the top cover to clear the jam message.
- 6 If the jam message persists, media remains in the product. Look for media in another location (see [“Jam locations” on page 78](#)).



Clearing jams from the duplexer

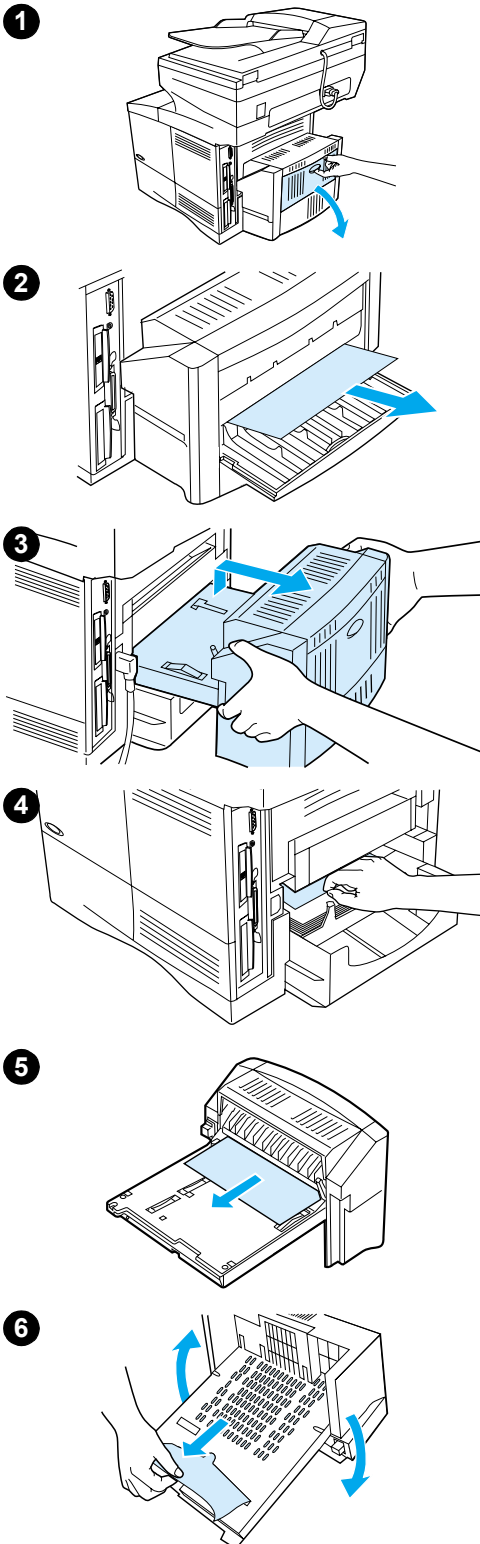

- 1 Open the duplexer's rear door.
- 2 Slowly pull any media out of the duplexer.
- 3 Remove the duplexer by lifting it slightly and pulling it out of the product.
- 4 From the rear of the product, remove any media that is on top of Tray 2. (You might need to reach inside the product.)
- 5 Slowly pull any media out of the duplexer.
- 6 Turn the duplexer over and remove any media.

Continued on the next page.



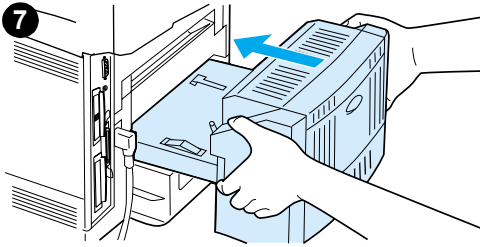

- 7 Reinsert the duplexer into the product.
- 8 Open and close the top cover to clear the jam message.
- 9 If a jam message persists, media remains in the product. Look for media in another location (see [“Jam locations” on page 78](#)).



Clearing jams from the rear output slot

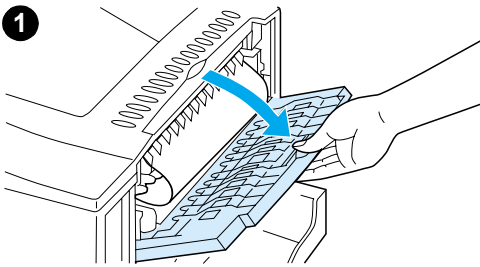

Note

If most of the media remains inside the product, it is best to remove it through the top cover area. (See [“Clearing jams from the top cover and toner cartridge area” on page 79](#).)

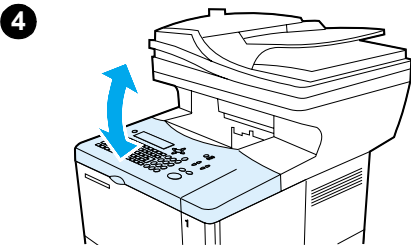

- 1 Open the rear output slot.
- 2 Grasp both sides of the media, and slowly pull it out of the product. (There might be loose toner on the media. Be careful not to spill it on yourself or into the product.)

Note

If media is difficult to remove, try opening the top cover completely to release pressure on the media.

If the media has torn or if you still cannot remove the media, see [“Clearing jams from the fuser area” on page 83](#).

- 3 Close the rear output slot.
- 4 Open and close the top cover to clear the jam message.
- 5 If a jam message persists, media remains in the product. Look for media in another location (see [“Jam locations” on page 78](#)).



Clearing jams from the fuser area

Use this procedure to remove jams from the fuser area:

- when media has jammed inside the fuser and cannot otherwise be removed.
- when a page has torn while you were trying to clear a jam from the fuser.

1 Turn the product off.

WARNING!

To avoid minor burns, wait 30 minutes for the fuser to cool before continuing with this procedure.

2 Turn the product so its rear cover faces you and remove the Tray 2 dust cover or optional duplexer.

3 Unplug the power cord from the product.

4 Open the rear output slot and pull the extension out until it stops.

5 Remove the rear output slot and extension. To do this, bend the middle down slightly, release tab a, and then release tab b.

6 Unlock the fuser by rotating the blue fuser levers so that they point up.

7 Pull the fuser out of the product. To release the fuser from the product, hold the back of the product while pulling on the fuser. Do not pull on the black plastic flapper.

Continued on the next page.

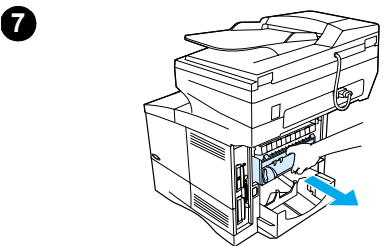
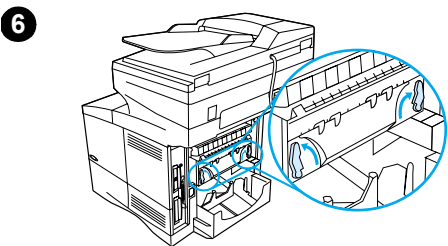
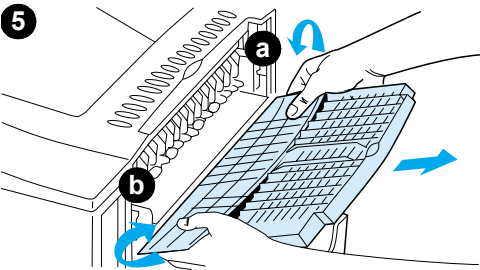
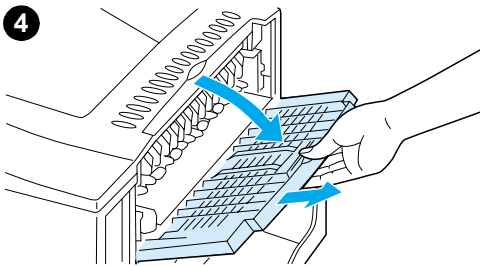
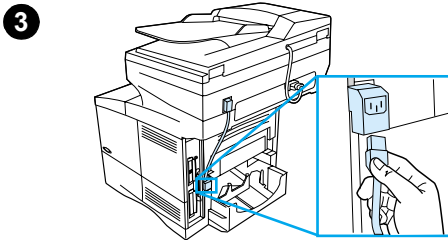
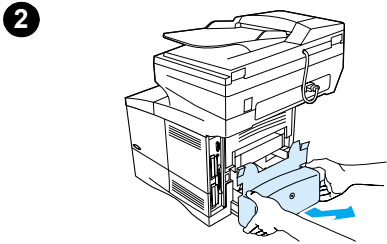

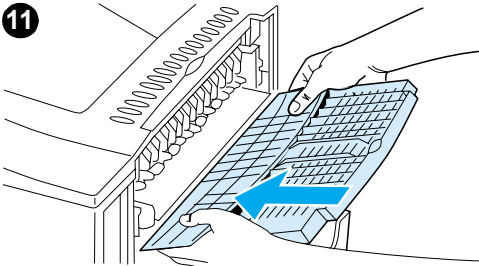
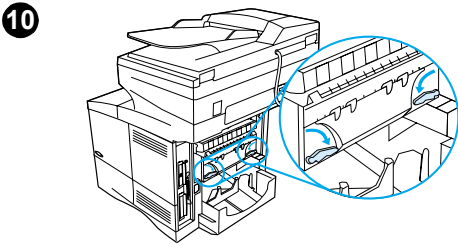
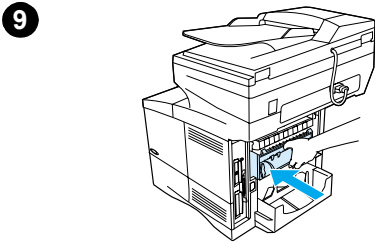
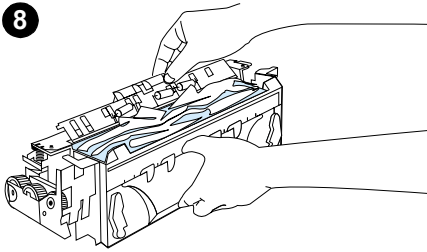

8 Remove the media that has jammed.

CAUTION

Do not use a sharp object to clear media from the fuser area. You might damage the fuser.

9 Replace the fuser, left side first. Be sure to push the fuser firmly into the product.

10 Lock the fuser in place by rotating the levers to the horizontal position.

11 Replace the rear output slot, left side first.

12 Plug the power cord into the product.

13 Replace the Tray 2 dust cover or the optional duplexer.

14 Turn the MFP on.

15 If a jam message persists, media remains in the product. Look for media in another location (see [“Jam locations” on page 78](#)).

Note

Because the product has been turned off, you must restart the copying or printing task.



Clearing jams from the ADF

If originals jam in the ADF, follow this procedure:

- 1 Raise the ADF cover.
- 2 Remove any jammed media.
- 3 Close the ADF and control panel unit. Press each down firmly until it clicks into place.
- 4 After removing the stack of originals from the ADF, smooth the jammed page, add it to the top of the stack, and reinsert the stack.
- 5 Press **START** to resume sending or copying the document.



Solving repeated jams

If jams occur frequently, try the following:

- Check all possible jam locations (see [“Clearing jams” on page 78](#)). A piece of media might be stuck somewhere in the product. Even a small torn piece of media in the paper path can cause repeated jams.
- If using a duplexer, check all areas of the MFP (including under the duplexer).
- Check that media is correctly loaded in the trays, that all three tray adjustments have been made, and that the trays are not overfilled. Make sure that the stack is tucked under the front and back tabs. (See the sections about loading media, starting with [“Loading Tray 1” on page 23](#).)
- Check that all trays and media-handling accessories are completely inserted into the MFP. (If a tray is opened during a job, this might cause a media jam.)
- Check that all covers and doors are closed. (If a cover or door is opened during a job, this might cause a jam.)
- Try printing or copying to a different output bin.
- The sheets might be sticking together. Try bending the stack to separate each sheet. Do not fan the stack.
- If you are printing or copying from Tray 1, try reducing the size of the stack.
- If you are printing or copying from the optional power envelope feeder, make sure that it is loaded correctly, and that the bottom envelopes are slightly farther in than the top envelopes.
- If you are printing or copying small media sizes, feed the media short edge first (see [“Guidelines for using custom paper” on page 28](#)).
- Turn over the stack of media in the tray. Also try rotating the media 180 degrees.
- Check the characteristics of the media you are using. Use only media that meets HP specifications (see [“Paper specifications” on page 113](#)). Try using different media to see if the problem goes away. Do not use curled, deformed, damaged, or irregular media.
- Check that the environmental conditions for the product are met (see [“Environmental specifications” on page 123](#)).
- Avoid using paper that has already been used in a printer or copier.
- Do not print on both sides of envelopes or transparencies (see [“Using envelopes” on page 26](#) or [“Using transparencies” on page 27](#)).
- Print or copy only on full sheets of labels and do not print or copy on both sides of label sheets (see [“Using labels” on page 27](#)).
- Check that the power supplied to the product is steady and meets product specifications (see [“Electrical specifications” on page 123](#)).
- Clean the product (see [“Cleaning the product” on page 71](#)).
- Perform preventative maintenance if maintenance is due (see [“Performing preventative maintenance” on page 76](#)).



Understanding control panel messages

The tables in this section explain common messages that might appear on the control panel display.

Within each table, the messages and their meanings are listed in alphabetical order, with numbered messages listed at the end of the tables.

If a message persists:

- If you see persistent messages requesting that you load a tray, or if a message indicates that a previous print job is still in the product’s memory, press **START** to print or press **STOP** to clear the job from memory.
- If a message persists after you complete all of the recommended actions, contact an HP-authorized service or support provider (see [“HP customer care service and support” on page 107](#)).

Not all messages are described in this guide (many are self-explanatory), but are addressed on the product pages in the embedded Web server.

The product generates two types of errors:

- temporary errors that you can correct
- equipment errors, which are usually generated by equipment failure and require action by service personnel



Control panel messages

Message	Explanation or recommended action
ACCESS DENIED MENUS LOCKED	The control panel function you are trying to use is locked to prevent unauthorized access. See your network administrator.
ADF COVER OPEN	The ADF cover is open and must be closed before copying can continue.
ADF MISPICK	The ADF feed mechanism was unable to pick the next page. Remove all pages and restack them in the proper order, straightening their edges. Press START to resume the copy job.
ADF OVERFILL	Too many pages have been placed in the ADF. Remove some of the pages and try the operation again. If necessary, raise the ADF tray and remove any jammed media, and then lower the ADF tray.
ADF PAPER JAM	A page has jammed inside the ADF and must be cleared before copying can continue. Raise the ADF tray and remove the jammed media, and then lower the ADF tray.
BAD DUPLEXER CONNECTION	The duplexer is not properly connected to the product. Use only the right-angle power cord that shipped with the product. Try removing and reinstalling the duplexer. Then turn the product off and back on.
BAD OPT TRAY CONNECTION	There is a problem with an optional 500-sheet paper tray connection with the product: <ul style="list-style-type: none"> ● The tray is not connected properly. ● More than two optional 500-sheet paper trays are installed (the product cannot support more than four trays). ● The electronics in the paper tray are faulty. Try removing and reinstalling the paper tray. Then turn the product off and back on.
BLOCKED JOB	The product is processing other jobs and cannot process your job at this time. Please wait. Your job will be processed as soon as the current job is completed.
BUSY PRINTING	A job is currently printing.
CANCELING <JOBNAME>	The current job is being canceled.



Control panel messages (continued)

Message	Explanation or recommended action
CANNOT DUPLEX CLOSE REAR BIN	The product cannot duplex because the rear output slot is open. Close the rear output slot.
CHECK INPUT DEVICE alternates with PAPER PATH OPEN PLEASE CLOSE IT	The optional input tray cannot feed media to the product because a door or paper guide is open. Check the doors and paper guides and close any that are open.
CHECK OUTPUT DEVICE alternates with CLOSE OUTPUT DELIVERY PATH	The optional output device is not properly connected to the product. A proper connection must be made for printing to continue.
CHECKING PAPER PATH	The engine is checking for possible jams or media that was not cleared from the product.
CLOSE TOP COVER	The top cover is open and must be closed for printing to continue.
CLOSE TOP OR LEFT DOOR	Either the top cover or left door is open and must be closed to allow printing to resume.
DISK DEVICE FAILURE	The EIO disk had a critical failure and can no longer be used. Remove the EIO disk and replace it with a new one.
DISK FILE OPERATION FAILED	The requested operation could not be performed. You might have attempted an illegal operation, such as trying to download a file to a non-existent directory.
DISK FILE SYSTEM IS FULL	Delete files from the EIO disk and then try again. (See the software Help for more information.)
DISK IS WRITE PROTECTED	The EIO disk is protected, and no new files can be written to it. Disable the write protection.
EIO [n] DISK INITIALIZING	The disk in EIO slot [n] is initializing.
EIO [n] DISK NOT FUNCTIONAL	The EIO disk is not working correctly. Remove the EIO disk from the slot indicated by [n]. Replace it with a new EIO disk.
EIO [n] INITIALIZING ALTERNATES WITH DO NOT POWER OFF	Wait for the message to disappear (this might take up to 5 minutes). If the product EIO card is operating correctly and communicating with the network, this message disappears after approximately 1 minute and no action is required. If the EIO card is unable to communicate with the network, this message remains for 5 minutes and then disappears. In this case the product is not communicating with the network (although the message is no longer present). The problem might be a bad EIO card, a bad cable or connection on the network, or a network problem. Contact your network administrator.
EIO [n] DISK SPINNING UP	The disk accessory in EIO slot [n] is initializing.
EXTERNAL DEVICE INITIALIZING	When an external paper-handling device is connected to the printer, it must initialize after the computer is turned on or after coming out of PowerSave mode.
INPUT DEVICE CONDITION [XX.YY]	An input paper-handling device requires attention before printing can resume. Turn the product off. Disconnect the cable to the input paper handling device and then reconnect it. Turn the product on. See the documentation that came with the paper-handling device for assistance.
INSTALL TONER CARTRIDGE	The toner cartridge has been removed and must be reinstalled for printing to continue.
INSTALL TRAY [X]	The specified tray is not installed and must be inserted and closed for printing to continue.



Control panel messages (continued)

Message	Explanation or recommended action
INTERRUPT COPY JOB	Do you want to interrupt the job currently being copied? Yes/No. If the job is interrupted, it will resume as soon as your job is completed.
MANUALLY FEED [TYPE] [SIZE]	Load the requested media into Tray 1. Press START if the desired media is already loaded in Tray 1.
MEMORY FULL STORED DATA LOST	There is no available memory. The current job might not print correctly and some resources (such as downloaded fonts or macros) might have been deleted.
MEMORY SETTINGS CHANGED	The product changed its memory settings because it did not have enough memory to use the previous settings for I/O Buffering and Resource Saving. This usually occurs after removing memory from the product, adding a duplexer, or adding a printer language.
MEMORY SHORTAGE JOB CLEARED	The product did not have enough memory to print the entire job. The remainder of the job will not print and will be cleared from memory. Press START to continue.
MEMORY SHORTAGE PAGE SIMPLIFIED	The product had to compress the job to fit it in available memory. Some data loss might have occurred. Press START to continue. The print quality of these pages might not be acceptable. Reduce the complexity of these pages and reprint them.
NON HP TONER CARTRIDGE DETECTED alternates with PRESS START TO CONTINUE	The product has detected that the toner cartridge is not an HP toner cartridge. If you believe you purchased an HP toner cartridge, call the HP fraud hotline. Any product repair required as a result of using non-HP toner is not covered under the product warranty.
OFFLINE	Press START to bring the product online.
OUTPUT BIN FULL alternates with CLEAR PAPER FROM [BINNAME]	The specified output bin is full and must be emptied for printing or copying to continue.
PAPER WRAPPED AROUND FUSER	Turn the product off to prevent the media from wrapping more firmly around the fuser. Open the top cover and remove the toner cartridge. Remove all visible media. If you cannot locate the media, leave product turned off and remove the fuser to reach the media (see “Clearing jams from the fuser area” on page 83).
PERFORM ROUTINE MAINTENANCE	To ensure optimal print quality, the product prompts you to perform routine maintenance every 200,000 pages. To order a printer maintenance kit, see “Ordering information” on page 125 . For information about maintenance, see “Performing preventative maintenance” on page 76 .
PRINTER LANGUAGE NOT AVAILABLE	A print job requested a printer language that does not exist in the printer. The job does not print and is cleared from memory. Print the job using a driver for a different printer language, or add the requested language to the product (if available). Press START to continue.
PROCESSING AUTO CLEANING PAGE	The auto cleaning page is in process. This can take up to 2.5 minutes.
PROCESSING CLEANING PAGE	The manual cleaning page process is underway. This can take up to 2.5 minutes.
SCAN AHEAD	Scanning pages. Your document is being scanned now. It will print when the current job is finished.
SCANNER COVER OPEN	The ADF cover on top of the scanner glass is open, preventing the scan from taking place. Close the cover and resume the operation.



Control panel messages (continued)

Message	Explanation or recommended action
TONER LOW	<p>The message first appears when about 15 percent of the toner remains in the toner cartridge (at 5 percent coverage, about 1,500 pages remain for the 10,000-page cartridge and about 900 pages remain for the 6,000-page cartridge). Depending on how the product has been configured, it either continues to print or stops. You might want to ensure that you have a replacement toner cartridge available.</p> <p>If the product has stopped, you can resume printing by pressing START for each job.</p> <p>See “Toner low and toner out conditions” on page 71 for information about configuring the product's response to toner messages.</p>
TONER OUT	<p>The toner cartridge is now empty. Depending on how the product has been configured, it either continues to print or stops.</p> <p>If the product has stopped, you can resume printing by pressing START for each job. Replace the toner cartridge.</p> <p>See “Toner low and toner out conditions” on page 71 for details on how to configure the product's response to toner messages.</p>
TRAY [X] EMPTY [TYPE] [SIZE]	<p>Load media in the empty tray (x) to clear the message. If you do not load the specified tray, the product continues printing from the next tray with the same media size and type, and the message continues to appear.</p>
TRAY [X] OPEN	<p>The specified tray is open. Close the tray to continue the job.</p>
TRAY 1 LOAD [TYPE] [SIZE]	<p>This message occurs for the following reasons:</p> <ul style="list-style-type: none"> ● Tray 1 was requested and the tray is empty. ● The requested media size is not found. ● If the correct media size is loaded, the tray or the control panel is not set correctly. <p>To adjust Tray 1 to accommodate special media, see “Loading Tray 1” on page 23. See also “Loading Tray 2 and optional Trays 3 and 4” on page 24.</p> <p>Load the requested media into Tray 1, or press START to override the message and print on a loaded media size.</p> <p>If printing does not continue, press START.</p> <p>If you are trying to print letter- or A4-size media and this message appears, make sure the default media size is set correctly from the Printing menu in the control panel and also in the software program.</p> <p>Press START to print from the next available tray.</p> <p>Press the down navigation button to scroll through the available types and sizes.</p> <p>Press ✓ to accept the alternative type or size.</p> <p>Note</p> <p>If custom size is being used, another line appears in the message giving the x and y dimensions of the media.</p>
TRAY [X] LOAD [TYPE] [SIZE] where x is Tray 2, 3, or 4	<p>This message occurs for the following reasons:</p> <ul style="list-style-type: none"> ● Tray 2, 3, or 4 was requested, but the tray is empty. ● Tray 2, 3, or 4 was requested, but the adjustments are not set for the requested media type or size. <p>Make sure that all paper guide adjustments have been made (see explanation in “Loading Tray 2 and optional Trays 3 and 4” on page 24). Also make sure that the type has been set at the control panel.</p> <p>Load the requested media into the indicated tray, or press ✓ to override the message and print on a loaded media size.</p> <p>If printing does not continue, press START.</p> <p>If you are trying to print letter- or A4-size media and this message appears, make sure the default media size is set correctly in the Printing menu at the control panel and also in the software program.</p> <p>Press START to print from the next available tray.</p> <p>Press the down navigation arrow to scroll through the available media types and sizes.</p> <p>Press ✓ to accept the alternative type or size.</p>



Control panel messages (continued)

Message	Explanation or recommended action
TRAY 1 SIZE = [xxxx]	<p>The product is asking what size of media has been loaded in Tray 1. In response, you can take either of the following actions:</p> <ul style="list-style-type: none"> ● Press ✓ to accept the current media size. ● Press the down navigation arrow to change the size and then press ✓ to accept the new size. <p>The product will first display the TRAY 1 TYPE=xxxx message (see the description of that message). If you do not press any buttons in the timeout period (about 1 minute), it displays this TRAY 1 SIZE= xxxx message.</p> <p>Note Changing the size here changes the default for Tray 1 media size in the Paper Handling menu.</p>
TRAY 1 TYPE = [XXXX]	<p>The product has received a job under any of these conditions:</p> <ul style="list-style-type: none"> ● The media type requested by the job is not available in the product. ● Tray 1 has been set for CASSETTE. ● Media has been placed in Tray 1 which has triggered Tray 1's paper sensor). <p>If you do press any buttons, the message disappears in about 1 minute. You can take either of the following actions:</p> <ul style="list-style-type: none"> ● Press ✓ to accept the media type. ● Press the down navigation arrow to change the type and then press ✓ to accept the new type. <p>Note Changing the type here changes the default for Tray 1 media type in the Paper Handling menu. If you do not do anything during the timeout period (about 1 minute), the product will print on the media in Tray 1. It will also change the default for Tray 1 media type in the Paper Handling menu to the type requested by the application that sent the job.</p>
UNABLE TO MOPY JOB	Memory or file system failures would not allow mopying to occur. Only one copy will be produced.
UNSUPPORTED SIZE IN TRAY [YY]	An external paper-handling device detected an unsupported media size. The product goes offline until the condition is corrected.
USE [TYPE] [SIZE] INSTEAD?	<p>If the requested media size or type is not available, the product asks if it should use another media size or type instead.</p> <p>Press the down navigation arrow to scroll through the available types and sizes. Press ✓ to accept the alternate type or size.</p>
XX.YY PRINTER ERROR PRESS START TO CONTINUE	A product error has occurred that can be cleared by pressing START on the control panel.
##.00.01 SCANNER I/O FAILURE CHECK CABLES AND CYCLE POWER	<p>Communication between the printer formatter and the copy module has failed. A disconnected cable or a failure of the copy module might have caused this communications failure.</p> <p>Check the connection between the copy connect card and the IEEE-1394 cable. If the problem persists, call for service.</p>
##.00.02 SCANNER I/O FAILURE	The IEEE-1394 copy connect card is not detected, either because initialization failed or because the card is not installed. Call for service.



Control panel messages (continued)

Message	Explanation or recommended action
##.XX.YY	<p>This message indicates a failure in the scanner device. This is not a communications failure. XX specifies the reporting systems (scanner job control, copy/send application, scanner service agent) and YY specifies the error condition. These are represented as ##.XX.YY in the event log. For example, the scanner log control can report the following errors:</p> <ul style="list-style-type: none"> • Scanner FPGA initialization error • Scanner EEPROM error • Scanner sensor adjustment error • Scanner ADF upper-light error • Scanner ADF lower-light error • Scanner ADF fan motor error • Pick sensor error • Scanner sensor error • Home position error • McBSP overrun error • CCD FIFO full error <p>Turn the power off and then turn it on again. If the error persists, call for service.</p>
13.X PAPER JAM [LOCATION]	<p>Media has either jammed in the product or been caught in a paper tray. The control panel provides specific instructions and location information to aid in clearing the jam.</p> <ul style="list-style-type: none"> • Open the top cover or tray indicated by the message. • Clear all media from the area. If necessary, remove the toner cartridge, duplexer, or trays. • If the message persists, check for media in all other areas. <p>CAUTION Ensure that all jammed media is removed before closing the cover or tray. Open and close the top cover to clear the message. See “Clearing jams” on page 78 for more detailed information.</p>
20 INSUFFICIENT MEMORY alternates with PRESS START TO CONTINUE	<p>The product received more data than can fit in available memory. You might have tried to transfer too many macros, soft fonts, or complex graphics. Press START to print the transferred data (some data might be lost) and then simplify the print job.</p>
21 PAGE TOO COMPLEX alternates with PRESS START TO CONTINUE	<p>The data (dense text, rules, raster or vector graphics) sent to the product is too complex. Press START to print the transferred data. (Some data might be lost.)</p>
22 EIO X BUFFER OVERFLOW alternates with PRESS START TO CONTINUE	<p>Too much data was sent to the EIO card in the specified slot (x). An improper communications protocol may be in use. Press START to clear the message. (Data might be lost.) Check the host configuration.</p>
22 PARALLEL I/O BUFFER OVERFLOW alternates with PRESS START TO CONTINUE	<p>Too much data was sent to the parallel port. Check for a loose cable connection and make sure to use a high-quality cable (see “Ordering information” on page 125). (Some non-HP parallel cables might be missing pin connections or might otherwise not conform to the IEEE-1394 specification.) This error can occur if the driver you are using is not IEEE-1394 compliant. For best results, use an HP driver that came with the product (see “Printer drivers” on page 58). Press START to clear the error message. (Data might be lost.)</p>
40 EIO [X] BAD TRANSMISSION alternates with PRESS START TO CONTINUE	<p>The connection between the product and the EIO card in the specified slot has been broken. (Data loss might occur in this situation.) Press START to clear the error message and continue printing.</p>



Control panel messages (continued)

Message	Explanation or recommended action
41.3 UNEXPECTED PAPER SIZE alternates with EXPECTED [TYPE] [SIZE]	<p>The product detected a media size other than what was specified. This is typically caused if two or more sheets stick together in the product or if the paper tray is not properly adjusted. Reload the tray with the correct media size and ensure that media in the tray is loaded under the front and back tabs.</p> <p>If you are printing from Tray 1, verify that the correct media size is selected in the control panel. If you are printing from Tray 2, 3, or 4, verify that the paper guides in the tray have been adjusted correctly (see the description of adjustments in “Loading Tray 2 and optional Trays 3 and 4” on page 24).</p> <p>After performing the actions above, press START. The page containing the error will automatically be reprinted if jam recovery is enabled. Or, you can press STOP to clear the job from memory.</p>
41.X PRINTER ERROR alternates with CYCLE POWER TO CONTINUE	<p>A temporary printing error occurred. Press START. The page containing the error will automatically be reprinted if jam recovery is enabled.</p> <p>If the error does not clear, turn the product off, and then turn the product on.</p>
49.XX PRINTER ERROR alternates with CYCLE POWER TO CONTINUE	<p>A temporary printing error occurred. Press START. The page containing the error will automatically be reprinted if jam recovery is enabled.</p> <p>If the error does not clear, turn the product off, and then turn the product on.</p>
50.X FUSER ERROR	<p>A fusing error has occurred. Turn the product off and then on.</p>
50.4 PRINTER ERROR alternates with CYCLE POWER TO CONTINUE	<p>A problem with the power supply has occurred. Remove the product from any uninterruptible power supply (UPS), additional power supplies, or power strips. Plug the product into a wall outlet and see if this resolves the problem.</p> <p>If the product is already plugged into a wall outlet, try another power source in the building that is independent of the one currently being used.</p> <p>The line voltage and current source at the product location might need to be inspected to make sure that it meets the product’s electrical specifications (see “Electrical specifications” on page 123).</p>
51.X OR 52.X PRINTER ERROR alternates with CYCLE POWER TO CONTINUE	<p>A temporary printing error occurred. Turn the product off, and then turn the product on.</p>
53.XY.ZZ PRINTER ERROR	<p>A problem with the product’s memory has occurred. The DIMM that caused the error will not be used. Values of x, y, and z are as follows:</p> <ul style="list-style-type: none"> 0 = ROM 1 = RAM Y = Device location 0 = Internal memory (ROM or RAM) 1 to 3 = DIMM slots 1, 2, or 3 ZZ = Error number <p>You might need to replace the specified DIMM. Turn the product off, and then replace the DIMM that caused the error.</p>
54.1 REMOVE SEALING TAPE alternates with FROM TONER CARTRIDGE	<p>The toner cartridge has been installed without removing the sealing tape. Open the top cover and remove the toner cartridge. Pull the sealing tape tab to remove the strip. Reinstall the toner cartridge and close the top cover.</p>



Control panel messages (continued)

Message	Explanation or recommended action
55.XX PRINTER ERROR alternates with CYCLE POWER TO CONTINUE	A temporary printing error occurred. Press START . The page containing the error automatically reprints if jam recovery is enabled. If the error does not clear, turn the product off, and then turn the product on.
56.X PRINTER ERROR alternates with CYCLE POWER TO CONTINUE	A temporary printing error occurred. Turn the product off, and then turn the product on.
57.X PRINTER ERROR alternates with CYCLE POWER TO CONTINUE	A temporary printing error occurred. Turn the product off, and then turn the product on.
58.X PRINTER ERROR alternates with CYCLE POWER TO CONTINUE	A temporary printing error occurred. Turn the product off, and then turn the product on.
59.X PRINTER ERROR alternates with CYCLE POWER TO CONTINUE	A temporary printing error occurred. Turn the product off, and then turn the product on.
62.X PRINTER ERROR	A problem with the product's memory has occurred. The x value refers to the location of the problem: <ul style="list-style-type: none"> 0 = Internal memory 1 to 3 = DIMM slots 1, 2, or 3 You might need to replace the specified DIMM.
64 PRINTER ERROR alternates with CYCLE POWER	A temporary printing error occurred. Turn the product off, and then turn the product on.
66.XX.XX SERVICE ERROR alternates with CHECK CABLES AND CYCLE POWER	An error occurred in an external paper-handling device. Turn the product off. Disconnect the cables to all external media handling devices, and then reconnect them. Turn the product on.
68.X PERMANENT STORAGE ERROR alternates with CHECK SETTINGS	An error occurred in the product's permanent storage and one or more product settings have been reset to the factory default. Print a configuration page and check the product settings to determine which values have changed (see "Information menu" on page 37).
68.X PERMANENT STORAGE FULL	The product's permanent storage is full. Some settings might have been reset to the factory defaults. Print a configuration page and check the product settings to determine which values have changed (see "Information menu" on page 37). Hold down STOP while turning the product on. This will clean up the permanent storage by removing old areas that are not being used.



Control panel messages (continued)

Message	Explanation or recommended action
79 SERVICE [XXXX]	<p>The product has detected an error.</p> <p>Press STOP to clear the print job from the product memory. Turn the product off, and then turn the product on.</p> <p>Try printing a job from a different software program. If the job prints, go back to the first program and try printing a different file. (If the message appears only with a certain software program or print job, contact the software vendor for assistance.)</p>
8X.YYYY EIO [Z] ERROR	<p>The EIO accessory in slot [z] has encountered a critical error. [z] description:</p> <ul style="list-style-type: none"> 1 = EIO slot 1: The product has detected an error with the EIO accessory. 2 = EIO slot 2: The product has detected an error with the EIO accessory. 6 = EIO slot 1: The EIO accessory has detected an error. The EIO accessory might be defective. 7 = EIO slot 2: The EIO accessory has detected an error. The EIO accessory might be defective. <p>Turn the product off, and then turn the product on.</p> <p>Turn the product off, reseal the EIO accessory in slot [z], and then turn the product on.</p> <p>Turn the product off, remove the EIO accessory from slot [z], install it in a different EIO slot, and then turn the product on.</p> <p>Replace the EIO accessory in slot [z].</p> <hr/> <p>The e-mail gateway is not configured. Contact your system administrator.</p> <hr/> <p>The e-mail gateway is not responding. Contact your system administrator.</p> <hr/> <p>The product experienced an error while executing the digital-sending job. The job has failed.</p> <hr/> <p>Processing a digital send job.</p> <hr/> <p>The address book is full. To add an additional address, you must first delete an address from the address book.</p> <hr/> <p>The system has found too many addresses to display. Please refine your search.</p> <hr/> <p>The e-mail addressing information was rejected because the address was incorrect or incomplete. The job has failed. Please correct the e-mail address and send the job again.</p> <hr/> <p>The e-mail gateway could not accept the job because the attachment is too large.</p>



Equipment error messages

Message	Explanation or recommended action
BLOWN MOTOR FUSE ERROR	The scanner reports this error when it detects that the motor fuse has blown.
BLOWN LAMP FUSE ERROR	The scanner reports this error when it detects that the lamp fuse has blown. This fuse is common to the front and back scanning lamps.
FRONT SIDE OPTICAL SYSTEM ERROR	The scanner reports this error when it detects a problem with the front side optical system.
MECHANICAL ERROR	The scanner reports this error when it detects a general mechanical problem.



Understanding mopy disk-error messages

The following table lists the mopy disk error numbers reported on the collation or job storage disk error pages that are printed when an error occurs.

Mopy disk error messages

Disk error no.	Error description	Solution
1	Disk volume not present—it may be uninitialized.	Initialize the hard disk. If the problem persists, replace the hard drive.
3	A requested file or directory could not be found.	Possible data corruption has occurred. Delete the job that prompted the error.
5	Invalid # of bytes given in a read/write request.	Possible data corruption has occurred. Delete the job that prompted the error.
6	Attempt to create a file or directory that already exists.	You have sent a user name that is the same as an existing directory. Change the user name in the driver and resend the job.
15	Bad disk.	Initialize the hard disk. If the problem persists, replace the hard drive.
16	No volume label.	Initialize the hard disk. If the problem persists, replace the hard drive.
23	Bad seek request—the resulting offset would be negative.	Possible data corruption has occurred. Delete the job that prompted the error.
24	Unexpected internal error.	<ul style="list-style-type: none"> • Possible data corruption has occurred. Delete the job that prompted the error. • A disk media problem has occurred. Initialize the hard disk. • If the problem persists on a hard drive, replace the hard drive.
55	Bad file system.	<ul style="list-style-type: none"> • Possible data corruption has occurred. Delete the job that prompted the error. • Disk media problem has occurred. Initialize the hard disk. • If the problem persists on a hard drive, replace the hard drive.
56	Hardware failure.	Replace the hard drive.
59	Stored jobs are stored in directories created for each user. A limited number of directories can be put on a disk and the maximum number of directories has been reached	<ul style="list-style-type: none"> • Delete all jobs stored for a user. The firmware automatically deletes the directory for a user with no stored jobs. • Delete other directories on the disk.
70	Disk error	Contact an HP-authorized service and support representative.



Troubleshooting the hard disk

Troubleshooting the hard disk

Item	Explanation
The product does not recognize the hard disk.	Turn the product off and verify that the hard disk is inserted correctly and is securely fastened. Print a configuration page to confirm that the hard disk has been recognized (see "Information menu" on page 37).
The disk is not initialized. DISK X NOT INITIALIZED	Use the Windows-based embedded Web server or the Macintosh-based HP LaserJet Utility to initialize the disk.
Disk failure. EIO X DISK NOT FUNCTIONAL	Turn the product off and make sure that the EIO disk is inserted correctly and securely fastened. If the message persists, the disk drive needs to be replaced.
The disk is write protected. DISK IS WRITE PROTECTED	Fonts and forms cannot be stored on the disk when the disk is write protected. Use the Windows-based embedded Web server or the Macintosh-based HP LaserJet Utility to remove the write protection from the disk.
You attempted to use a disk-resident font, but the product substituted a different font.	If you are using PCL, print the PCL font page, and verify that the font is on the disk. If you are using PS, print the PS font page and make sure that the font is on the disk.



Correcting output quality problems

This section identifies common output quality problems and recommends solutions. Often output quality problems can be handled easily by ensuring that the product is properly maintained, using media that meets HP specifications, or running a cleaning page.

If you still experience problems after trying the suggested remedies, contact HP Customer Care Service and Support (see [“HP customer care service and support” on page 107](#)).



Note

The examples below represent letter-size paper that has passed through the product short-edge first.



Light print (partial page)

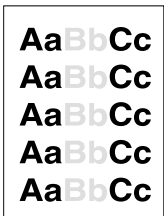

- 1 The toner cartridge might be low. Replace the toner cartridge.
- 2 Maintenance might be due. Check this by printing a copy of the supplies status page (see [“Information menu” on page 37](#)). If maintenance is due, order and install the printer maintenance kit (see [“Performing preventative maintenance” on page 76](#)).

Light print (entire page)



- 1 At the control panel display, use the Print Quality menu to increase the toner density setting.
- 2 Try using a different type of paper.
- 3 The toner cartridge might be low. Replace the toner cartridge.

Specks

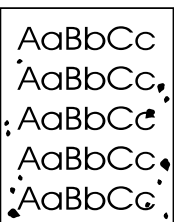

Specks might appear on a page after a jam has been cleared.

- 1 Print a few more pages to see if the problem corrects itself.
- 2 If specks occur frequently, configure the product to run a cleaning page automatically.
- 3 Clean the inside of the product (see [“Cleaning the product” on page 71](#)) and run a manual cleaning page to clean the fuser.
- 4 Try using a different type of paper.
- 5 Check for toner cartridge leaks. If the toner cartridge is leaking, replace it.

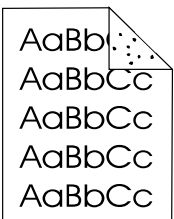

Dropouts

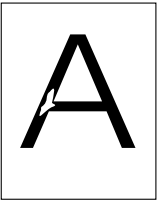

- 1 Make sure that the environmental specifications for the product are met (see [“General specifications” on page 124](#)).
- 2 If the paper is rough and the toner easily rubs off, either try changing the fuser mode to **High 1** or **High 2**, or try using a smoother paper.
- 3 Try changing to a different paper type.



Lines

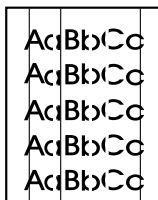

- 1 Print a few more pages to see if the problem corrects itself.
- 2 Clean the inside of the product (see [“Cleaning the product” on page 71](#)) and run a manual cleaning page to clean the fuser (see [“Cleaning the fuser” on page 73](#)).
- 3 Replace the toner cartridge.
- 4 Maintenance might be due. Check this by printing a copy of the supplies status page (see [“Information menu” on page 37](#)). If maintenance is due, order and install the printer maintenance kit (see [“Performing preventative maintenance” on page 76](#)).

Gray background



- 1 Do not use paper that has already been run through the product.
- 2 Print a few more pages to see if the problem corrects itself.
- 3 Turn over the stack of paper in the tray. Also, try rotating the paper 180 degrees.
- 4 At the control panel, use the Print Quality menu to decrease the toner density setting.
- 5 Make sure that the environmental specifications for the product are met (see [“General specifications” on page 124](#)).
- 6 Replace the toner cartridge.



Toner smear



See also [“Loose toner” on page 99](#).

- 1 Print a few more pages to see if the problem corrects itself.
- 2 Try using a different type of paper.
- 3 Make sure that the environmental specifications for the product are being met (see [“General specifications” on page 124](#)).
- 4 Clean the inside of the product (see [“Cleaning the product” on page 71](#)) and run a manual cleaning page to clean the fuser (see [“Cleaning the fuser” on page 73](#)).
- 5 Maintenance might be due. Check this by printing a copy of the supplies status page (see [“Information menu” on page 37](#)). If maintenance is due, order and install the printer maintenance kit (see [“Performing preventative maintenance” on page 76](#)).
- 6 Replace the toner cartridge.



Loose toner

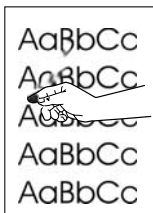

Loose toner, in this context, is defined as toner that can be rubbed off the page.

- 1 If paper is heavy or rough, try using a high fuser mode so that toner fuses more completely onto the paper.
- 2 If your paper has a rougher texture on one side, try printing on the smoother side.
- 3 Make sure that the environmental specifications for the product are met (see [“Product specifications” on page 122](#)).
- 4 Make sure that paper type and quality meet HP specifications (see [“Paper specifications” on page 113](#)).
- 5 Maintenance might be due. Check this by printing a copy of the supplies status page (see [“Information menu” on page 37](#)). If maintenance is due, order and install the printer maintenance kit (see [“Performing preventative maintenance” on page 76](#)).

Repeating defects



See also [“Repeating image” on page 100](#).

- 1 Print a few more pages to see if the problem corrects itself.
- 2 If the distance between defects is 38.00 mm (1.50 inches) or 94.00 mm (3.76 inches), the toner cartridge might need to be replaced.
- 3 Clean the inside of the product (see [“Cleaning the product” on page 71](#)) and run a manual cleaning page to clean the fuser (see [“Cleaning the fuser” on page 73](#)).
- 4 Maintenance might be due. Check this by printing a copy of the supplies status page (see [“Information menu” on page 37](#)). If maintenance is due, order and install the printer maintenance kit (see [“Performing preventative maintenance” on page 76](#)).



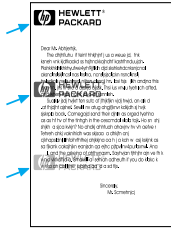

Repeating image

This type of defect might occur when using preprinted forms or printing a large quantity of narrow media.

- 1 Print a few more pages to see if the problem corrects itself.
- 2 Make sure that paper type and quality meet HP specifications (see [“Paper specifications” on page 113](#)).
- 3 If you observe that this type of defect occurs on wide paper (such as letter- or A4-size paper) just after printing on narrow media (such as envelopes), you can set `SMALL PAPER SPEED` on the Paper Handling menu to `SLOW`.
- 4 Maintenance might be due. Check this by printing a copy of the supplies status page (see [“Information menu” on page 37](#)). If maintenance is due, order and install the printer maintenance kit (see [“Performing preventative maintenance” on page 76](#)).



Misformed characters

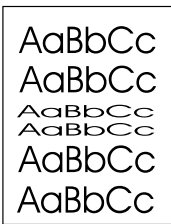

- 1 Print a few more pages to see if the problem corrects itself.
- 2 Make sure that the environmental specifications for the product are met (see [“General specifications” on page 124](#)).
- 3 Maintenance might be due. Check this by printing a copy of the supplies status page (see [“Information menu” on page 37](#)). If maintenance is due, order and install the printer maintenance kit (see [“Performing preventative maintenance” on page 76](#)).

Curl or wave

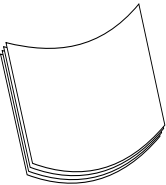

- 1 Turn over the stack of paper in the tray. Also, try rotating the paper 180 degrees.
- 2 Make sure that paper type and quality meet HP specifications (see [“Paper specifications” on page 113](#)).
- 3 Make sure that the environmental specifications for the product are met (see [“Product specifications” on page 122](#)).
- 4 Try printing to a different output bin.

If the media being used is lightweight and smooth, try using a low fuser mode to reduce the heat in the fusing process.

Page skew

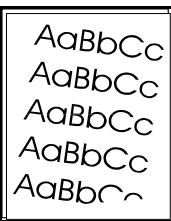

- 1 Print a few more pages to see if the problem corrects itself.
- 2 Verify that there are no torn pieces of paper inside the product.
- 3 Make sure that paper is loaded correctly, all adjustments have been made, and the paper is tucked under the corner tabs (see [“Loading Tray 1” on page 23](#) and [“Loading Tray 2 and optional Trays 3 and 4” on page 24](#)).
- 4 Make sure that the job is loaded in the ADF properly, and that there are no folded corners in the stack.
- 5 Turn over the stack of paper in the tray. Also, try rotating the paper 180 degrees.
- 6 Make sure that paper type and quality meet HP specifications (see [“Paper specifications” on page 113](#)).
- 7 Make sure that the environmental specifications for the product are met (see [“General specifications” on page 124](#)).



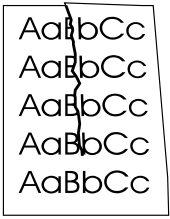

Wrinkles or creases

- 1 Print a few more pages to see if the problem corrects itself.
- 2 Make sure that the environmental specifications for the product are being met (see [“General specifications” on page 124](#)).
- 3 Turn over the stack of paper in the tray. Also, try rotating the paper 180 degrees.
- 4 Make sure that paper is loaded correctly, all adjustments have been made, and the paper is under the corner tabs (see [“Loading Tray 1” on page 23](#) and [“Loading Tray 2 and optional Trays 3 and 4” on page 24](#)).
- 5 Make sure that paper type and quality meet HP specifications (see [“Paper specifications” on page 113](#)).
- 6 If envelopes are creasing, try storing envelopes so that they lie flat.

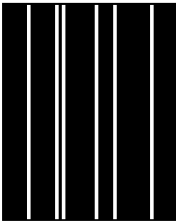

Vertical white lines

- 1 Print a few more pages to see if the problem corrects itself.
- 2 Make sure that paper type and quality meet HP specifications (see [“Paper specifications” on page 113](#)).
- 3 Replace the toner cartridge.

Tire tracks

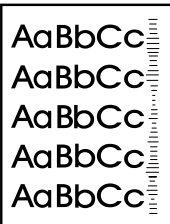

This defect typically occurs when the toner cartridge has greatly exceeded its rated usage of 10,000 pages (for example, after printing a very large number of pages with very little toner coverage).

- 1 Replace the toner cartridge.
- 2 Reduce the number of pages that you print with very low toner coverage.
- 3 Use the 6,000-page cartridge if you cannot reduce the number of pages to be printed with very little toner coverage (part number C8061A).

White spots on black

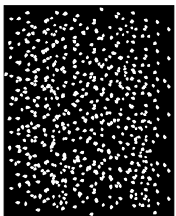

- 1 Print a few more pages to see if the problem corrects itself.
- 2 Make sure that paper type and quality meet HP specifications (see [“Paper specifications” on page 113](#)).
- 3 Make sure that the environmental specifications for the product are met (see [“General specifications” on page 124](#)).
- 4 Replace the toner cartridge.



ADF recalibration

Occasionally a copied image may not appear to be aligned properly on the page. Often this can be corrected by ensuring that the originals are properly loaded into the ADF and that there are no folded corners on any pages, since these could cause improper feeding.

However, if the image misalignment appears consistently, you should recalibrate the ADF. ADF recalibration is an automatic process that involves basic two steps:

- 1 printing the target pages to be used for calibration
- 2 scanning the printed target pages to perform the actual calibration

To recalibrate the ADF, select the **Calibrate Scanner** option in the **Diagnostics** menu. The MFP displays the following instructions to guide you through the calibration process. Pressing **STOP** at any of these prompts will cancel the calibration.

- TO PRINT FIRST TARGET PAGE, MANUALLY FEED ONE SHEET OF PAPER OF SIZE: [DEFAULT PAPER SIZE].
PRESS START.
TO QUIT, PRESS STOP.
- To print second target, press START.
To quit, press STOP.



Note

The MFP will pull the second page from Tray 2. No action is required by the user.

- Load target pages face down in the ADF in the direction indicated on the pages.
Press START.
To quit, press STOP.
- Calibration running.
Do not raise cover.

Note

When the recalibration is complete, dispose of the target pages.



Troubleshooting PostScript issues

PostScript troubleshooting

Item	Explanation
A text listing of PS commands prints instead of your PS printing job.	The control panel <code>PERSONALITY=AUTO</code> setting might have been confused by a nonstandard PS code. Check the <code>PERSONALITY</code> setting to see if it is set to <code>PS</code> or to <code>PCL</code> . If it is set to <code>PCL</code> , set it to <code>PERSONALITY=AUTO</code> . If it is set to <code>AUTO</code> , set it to <code>PS</code> for this print job only. When the job has printed, return the setting to <code>AUTO</code> .
The job prints in Courier (the default font) instead of the font you requested.	The requested typeface is not available in the product or is not present on the disk. Use a font download utility to download the desired font. Fonts downloaded to memory are lost when the product is turned off. They are also lost if Resource Saving is not used and a personality switch is performed to print a PCL job. Disk fonts are not affected by PCL jobs or by turning the product off. Print a PS Font Page to verify that the font is available. If a disk font appears to be missing, it might be because a software utility was used to delete the font, because the disk was reinitialized, or because the disk drive is not installed correctly. Print a configuration page to verify that the disk drive is installed and functioning correctly (see “Information menu” on page 37).
A page prints with clipped margins.	If the page margins are clipped, you might have to print the page at 300-dpi resolution or install more memory.
A page fails to print.	Set <code>PRINT PS ERRORS=ON</code> and then send the job again to print a PS Error page.
A PS error page prints.	Make sure the print job is a PS job. Check to see whether your software expected you to send a setup or PS header file to the product. Check the product setup in your software application to make sure that the product is selected. Check cable connections to make sure that they are secure. Reduce the complexity of the graphic.
Product pulls media from the wrong tray.	Use the information in “Customizing trays for printing or copying” on page 63 to change the tray being used.



Troubleshooting optional HP Fast InfraRed Connect problems

Troubleshooting HP Fast InfraRed Connect problems

Item	Explanation
FIR port status indicator does not light up.	Make sure that the product is in READY mode and that the FIR port you are printing from is IrDA-compliant and within the range of operation described in the user guide for the FIR port Make sure that the FIR port is properly connected to the product. Print a configuration page (see “Information menu” on page 37). Make sure that “FIR POD (IrDA Compliant)” is printed under Installed Personalities and Options.
Connection cannot be established or seems to take longer than usual.	Use a device that is IrDA-compliant. Look for an IrDA symbol on the device or see the computer’s user guide for IrDA specifications. Connection often cannot take place because the computer does not have the software that is required for the FIR port. Make sure that the operating system on your computer includes an FIR driver and your software program uses a compatible driver. Note that complex pages take longer to print. Position the FIR port within the range of operation described in the user guide for the FIR port. Make sure that no object is blocking the connection. (This object could be a hand, media, books, or even bright light.) Make sure that the two IR ports are clean (free from dirt and grease). Bright light of any kind (sunlight, incandescent light, fluorescent light, or light from an infrared remote control, such as those used for TVs and VCRs) shining directly into one of the IR ports might cause interference. Make sure that no bright light is shining directly into either IR port. Position the portable device closer to the FIR port on the product.
The product prints only part of a page or document.	The connection has been broken during transmission. If you move the portable device during transmission, the connection can be broken. IrDA-compliant devices are designed to recover from temporary connection interruptions. You have up to 40 seconds to reestablish the connection (depending on the portable device being used).
The print job has been properly sent, but the product will not print.	If the connection is broken before the entire print job has been transmitted to the product (printing has not yet started), the product might not print any of the job. Press STOP to clear the product memory. Then, reposition the portable device within the range of operation described in the user guide for the FIR port, and print the job again.
The FIR status indicator turns off during transmission.	The connection might have been broken. Press STOP to clear the product memory. Then, reposition the portable device within the range of operation described in the user guide for the FIR port, and print the job again.



Troubleshooting an HP Jetdirect print server

If the HP Jetdirect 10/100TX print server cannot communicate with the network, use these steps to verify the operation of the print server.

- Check the HP Jetdirect configuration page (to print, see [“Using the embedded Web server” on page 138](#)).
 - If the message `I/O CARD READY` does not appear on the HP Jetdirect configuration page, see the troubleshooting section of the *HP Jetdirect Print Server Administrator's Guide*.
 - The message `LOSS OF CARRIER ERROR` indicates that the print server failed to link to the network.
- Check the link-speed indicators (10 or 100) on the print server. If both are off, the print server failed to link to the network.



If the print server failed to link, verify that all cables are correctly connected. If all cables are correctly connected and the print server still fails to link, follow the steps below to reconfigure the print server:

- 1 Through the embedded Web server, use the EIO menu to set the link speed manually (10 or 100 Mbps) and duplex mode (full- or half-duplex) so that they match the network. For example, if the port on the network switch is set for 100TX full-duplex operation, you must set the print server for 100TX full-duplex operation.
- 2 Turn the product off and then back on. Check the print server operation. If the print server still fails to link, try a different network cable.





9

Service and support

HP customer care service and support



Online services

We suggest the services listed in this section to ensure access to information about the HP LaserJet 4100 mfp series.



World Wide Web

Printer drivers, updated HP printer software, plus product and support information can be obtained from <http://www.hp.com/lj4100mfp>.

HP service parts information CD

This CD-based parts information tool provides fast, easy access to parts information such as pricing and recommended stocking lists for a wide range of HP products. To subscribe to this quarterly service in the U.S. or Canada, call (1) (800) 336-5987. In Asia Pacific, call (65) 740-4484. Parts identification and pricing information worldwide can also be found on the World Wide Web at <http://www.hp.com/go/partsinfo>.

HP Support Assistant CD

This support tool offers a comprehensive online information system designed to provide technical and product information about HP products. To subscribe to this quarterly service in the U.S. or Canada, call (1) (800) 457-1762. In Hong Kong, Indonesia, Malaysia, or Singapore, call Mentor Media at (65) 740-4477.

HP authorized resellers and support

To locate authorized HP resellers and support in the U.S, call (1) (800) 243-9816. In Canada, call (1) (800) 387-3867.

HP service agreements

In the U.S., call (1) (800) 743-8305. In Canada, call (1) (800) 268-1221.

HP SupportPacks

The HP SupportPack is a packaged service agreement that upgrades the basic 1-year warranty, and extends coverage to 5 years. HP SupportPacks are sold by HP resellers and are available in a shrink-wrap version for a 3-year service package only (you must register with HP to activate this service) or an electronic version for a 1-, 2-, 3-, 4-, or 5-year service package (you can register by fax or on the World Wide Web).



For ordering and pricing details, contact your local HP reseller or visit the HP website at <http://www.hp.com/go/printerservices> for information.

HP fraud hotline

Call the HP fraud hotline at (1) (877) 219-3183 (toll-free in North America) when you install an HP LaserJet toner cartridge and the product message says the cartridge is not an HP toner cartridge. HP will help you determine if the product is genuine and take steps to resolve the problem.

Your toner cartridge might not be genuine if:

- you are experiencing a high number of problems with the toner cartridge.
- the cartridge does not look like it usually does (for example, the pull tab or the box is different).



Customer support options



HP Customer Care Center and product repair assistance for the U.S. and Canada



For technical support and help in identifying whether a product needs repair, call (1) (208) 323-2551 in the U.S. or (1) (905) 206-4663 in Canada Monday through Friday from 6:00 A.M. to 6:00 P.M. (Mountain Time) free of charge during the warranty period. However, your standard long-distance phone charges still apply. Have your MFP nearby and your product serial number ready when calling.

If you know that your product needs repair, call (1) (800) 243-9816 to locate your nearest authorized HP service provider.

If the product warranty has expired, post-warranty telephone assistance is available to answer your product questions. Call (1) (900) 555-1500 (\$2.50* per minute, U.S. only) or call (1) (800) 999-1148 (\$25* per call, Visa or MasterCard, U.S. and Canada) Monday through Friday from 7:00 A.M. to 6:00 P.M. (Mountain Time). *Charges begin only when you connect with a support technician. *Prices are subject to change.*

Warranty information

For warranty statements, see [“Hewlett-Packard limited warranty statement” on page 109](#) and [“Limited warranty for toner cartridge life” on page 110](#). You can also locate product warranties on the World Wide Web (see [“World Wide Web” on page 107](#)).

- If product hardware fails during the warranty period, see [“HP Customer Care Center and product repair assistance for the U.S. and Canada” on page 108](#) or [“Warranty information” on page 108](#).
- If product hardware fails after the warranty period, and you have an HP Maintenance Agreement or HP Support Pack, request service as specified in the agreement.
- If you do not have an HP Maintenance Agreement or HP Support Pack, contact an HP-authorized service or support provider (see [“HP authorized resellers and support” on page 107](#)).



If you are shipping equipment to be serviced, use the following repacking guidelines.



Hewlett-Packard limited warranty statement

HP PRODUCT	DURATION OF WARRANTY
HP LaserJet 4100 mfp	1 year, next day, onsite

- 1 HP warrants to you, the end-user customer, that HP hardware, accessories and supplies will be free from defects in materials and workmanship after the date of purchase, for the period specified above. If HP receives notice of such defects during the warranty period, HP will, at its option, either repair or replace products which prove to be defective. Replacement products may be either new or equivalent in performance to new.
- 2 HP warrants to you that HP software will not fail to execute its programming instructions after the date of purchase, for the period specified above, due to defects in material and workmanship when properly installed and used. If HP receives notice of such defects during the warranty period, HP will replace software which does not execute its programming instructions due to such defects.
- 3 HP does not warrant that the operation of HP products will be uninterrupted or error free. If HP is unable, within a reasonable time, to repair or replace any product to a condition as warranted, you will be entitled to a refund of the purchase price upon prompt return of the product.
- 4 HP products may contain remanufactured parts equivalent to new in performance or may have been subject to incidental use.
- 5 Warranty does not apply to defects resulting from (a) improper or inadequate maintenance or calibration, (b) software, interfacing, parts or supplies not supplied by HP, (c) unauthorized modification or misuse, (d) operation outside of the published environmental specifications for the product, or (e) improper site preparation or maintenance.
- 6 TO THE EXTENT ALLOWED BY LOCAL LAW, THE ABOVE WARRANTIES ARE EXCLUSIVE AND NO OTHER WARRANTY OR CONDITION, WHETHER WRITTEN OR ORAL, IS EXPRESSED OR IMPLIED AND HP SPECIFICALLY DISCLAIMS ANY IMPLIED WARRANTIES OR CONDITIONS OF MERCHANTABILITY, SATISFACTORY QUALITY, AND FITNESS FOR A PARTICULAR PURPOSE. Some countries, states or provinces do not allow limitations on the duration of an implied warranty, so the above limitation or exclusion might not apply to you. This warranty gives you specific legal rights and you might also have other rights that vary from country to country, state to state, or province to province.
- 7 TO THE EXTENT ALLOWED BY LOCAL LAW, THE REMEDIES IN THIS WARRANTY STATEMENT ARE YOUR SOLE AND EXCLUSIVE REMEDIES. EXCEPT AS INDICATED ABOVE, IN NO EVENT WILL HP OR ITS SUPPLIERS BE LIABLE FOR LOSS OF DATA OR FOR DIRECT, SPECIAL, INCIDENTAL, CONSEQUENTIAL (INCLUDING LOST PROFIT OR DATA), OR OTHER DAMAGE, WHETHER BASED IN CONTRACT, TORT, OR OTHERWISE. Some countries, states or provinces do not allow the exclusion or limitation of incidental or consequential damages, so this limitation or exclusion may not apply to you.
- 8 THE WARRANTY TERMS CONTAINED IN THIS STATEMENT, EXCEPT TO THE EXTENT LAWFULLY PERMITTED, DO NOT EXCLUDE, RESTRICT OR MODIFY AND ARE IN ADDITION TO THE MANDATORY STATUTORY RIGHTS APPLICABLE TO THE SALE OF THIS PRODUCT TO YOU.



Limited warranty for toner cartridge life

Note

The warranty below applies to the toner cartridge that came with your MFP. This warranty supersedes all previous warranties (07/19/1996).

The HP toner cartridge is warranted to be free from defects in materials and workmanship for the life of the cartridge until the HP toner is depleted. Your HP toner is depleted when your product indicates a toner-low message. HP will, at their option, either replace products that prove to be defective or refund your purchase price.



The warranty does not cover toner cartridges that have been refilled or have been emptied, abused, misused, or tampered with in any way.



This limited warranty gives you specific legal rights. You might have other rights which vary from state to state, province to province, and country to country.



To the extent allowed by applicable law, in no event shall Hewlett-Packard Company be liable for any incidental, consequential, special, indirect, punitive, or exemplary damages or lost profits from any break of this warranty or otherwise.



HP software license terms

ATTENTION: USE OF THE SOFTWARE IS SUBJECT TO THE HP SOFTWARE LICENSE TERMS SET FORTH BELOW. USING THE SOFTWARE INDICATES YOUR ACCEPTANCE OF THESE LICENSE TERMS. IF YOU DO NOT ACCEPT THESE LICENSE TERMS, AND THE SOFTWARE IS BUNDLED WITH ANOTHER PRODUCT, YOU MAY RETURN THE ENTIRE UNUSED PRODUCT FOR A FULL REFUND.

The following License Terms govern your use of the accompanying Software unless you have a separate signed agreement with HP.



License Grant

HP grants you a license to Use one copy of the Software. "Use" means storing, loading, installing, executing, or displaying the Software. You may not modify the Software or disable any licensing or control features of the Software. If the Software is licensed for "concurrent use," you may not allow more than the maximum number of authorized users to Use the Software concurrently.



Ownership

The Software is owned and copyrighted by HP or its third party suppliers. Your license confers no title to, or ownership in, the Software and is not a sale of any rights in the Software. HP's third party suppliers may protect their rights in the event of any violation of these License Terms.

Copies and Adaptations

You may only make copies or adaptations of the Software for archival purposes or when copying or adaptation is an essential step in the authorized Use of the Software. You must reproduce all copyright notices in the original Software on all copies or adaptations. You may not copy the Software onto any public network.

No Disassembly or Decryption

You may not disassemble or decompile the Software unless HP's prior written consent is obtained. In some jurisdictions, HP's consent may not be required for limited disassembly or decompilation. Upon request, you will provide HP with reasonably detailed information regarding any disassembly or decompilation. You may not decrypt the Software unless decryption is a necessary part of the operation of the Software.

Transfer

Your license will automatically terminate upon any transfer of the Software. Upon transfer, you must deliver the Software, including any copies and related documentation, to the transferee. The transferee must accept these License Terms as a condition to the transfer.



Termination

HP may terminate your license upon notice for failure to comply with any of these terms. Upon termination, you must immediately destroy the Software, together with all copies, adaptations, and merged portions in any form.

Export Requirements

You may not export or reexport the Software or any copy or adaptation in violation of any applicable laws or regulations.

U.S. Government Restricted Rights

The Software and any accompanying documentation have been developed entirely at private expense. They are delivered and licensed as “commercial computer software” as defined in DFARS 252.227-7013 (Oct 1988), DFARS 252.211-7015 (May 1991), or DFARS 252.227-7014 (Jun 1995), as a “commercial item” as defined in FAR 2.101 (a), or as “Restricted computer software” as defined in FAR 52.227-19 (Jun 1987) (or any equivalent agency regulation or contract clause), whichever is applicable. You have only those rights provided for such Software and any accompanying documentation by the applicable FAR or DFARS clause or the HP standard software agreement for the product involved.



A

Specifications

Overview

This appendix presents paper and product specifications for the HP LaserJet 4100 mfp series:

- paper specifications
- product specifications

Paper specifications

HP's multifunction printers are based on known HP technology and deliver excellent quality. The HP LaserJet 4100 mfp series accepts a variety of media, such as cut-sheet paper (including recycled paper), envelopes, labels, transparencies, and custom-size paper. Paper properties such as weight, grain, and moisture content are important factors affecting product performance and output quality.

The product can use a variety of paper and other print media in accordance with these guidelines. Paper that does not meet these guidelines can cause:

- poor print quality.
- increased jams.
- premature wear on the product, requiring repair.

For best results, use only high-quality media, such as HP-brand paper and print media. HP cannot recommend the use of other brands. Because they are not HP products, HP cannot influence or control their quality.

It is possible for paper to meet these guidelines and still not produce satisfactory results. This might be the result of improper handling, unacceptable temperature and humidity levels, or other variables over which HP has no control.

Before purchasing a large quantity of print media, make sure it meets the requirements specified in this user guide and in the *Print Media Guide*. (The guide can be found at <http://www.hp.com/support/ljpaperguide>.) Always test paper before purchasing a large quantity.

Using print media that is outside HP specifications can cause problems for the product, requiring repair. This repair is not covered by the HP warranty or service agreements.



Supported paper sizes and weights

Supported paper sizes and weights (one-sided printing) for Tray 1

Type	Size ¹	Weight or thickness	Capacity ²
Paper	Minimum custom size: 76 by 127 mm (3 by 5 inches) Maximum custom size: 216 by 356 mm (8.5 by 14 inches)	Weight: 60 to 199 g/m ² (16 to 53 lb)	100 sheets of 75 g/m ² (20 lb) paper
Transparencies		Thickness: 0.099 to 0.114 mm (0.0039 to 0.0045 inch)	50 transparencies
Labels		Thickness: 0.127 to 0.178 mm (0.005 to 0.007 inch)	50 sheets of labels
Envelopes		Weight: 75 to 105 g/m ² (20 to 28 lb)	10 envelopes



1. The product supports a wide range of paper sizes. Check the product software for supported sizes. To print custom-size paper, see [“Using cards and custom-size or heavy paper” on page 28](#).
2. Capacity can vary depending on media weight and thickness, and environmental conditions.



Supported paper sizes and weights for Trays 2, 3, and 4

Type	Size ¹	Weight or thickness	Capacity ²
Paper	Letter 216 by 279 mm (8.5 by 11 inches)	Weight: 60 to 105 g/m ² (16 to 28 lb)	500 sheets of 75 g/m ² (20 lb) paper
	A4 210 by 297 mm (8.3 by 11.7 inches)		
	Executive 191 by 267 mm (7.3 by 10.5 inches)		
	Executive (JIS) (custom ³) 216 by 330 mm (8.5 by 13 inches)		
	16K (custom ³) 197 by 273 mm (7.75 by 10.75 inches)		
	Legal 216 by 356 mm (8.5 by 14 inches)		
	B5 (ISO) (custom ³) 176 by 250 mm (6.9 by 9.9 inches)		
	B5 (JIS) 182 by 257 mm (7.2 by 10 inches)		
	A5 148 by 210 mm (5.8 by 8.2 inches)		
	Custom ³ 148 by 210 mm to 216 by 356 mm (5.8 by 8.2 inches to 8.5 by 14 inches)		
	Transparencies		
A4 210 by 297 mm (8.3 by 11.7 inches)			



1. The product supports a wide range of media sizes. Check the product software for supported sizes.
2. Capacity can vary depending on media weight and thickness, and environmental conditions.
3. To print custom-size paper, see [“Using cards and custom-size or heavy paper” on page 28.](#)

Supported paper sizes and weights for the optional power envelope feeder

Size	Dimensions	Weight	Capacity
Monarch (#7 ³ / ₄)	98.4 by 190.5 mm (3.88 by 7.50 inches)	75 to 105 g/m ² (20 to 28 lb)	75 envelopes
Commercial 10 (#10)	104.9 by 241.3 mm (4.13 by 9.5 inches)		
DL ISO	110 by 220 mm (4.33 by 8.66 inches)		
C5 ISO	162 by 229 mm (6.38 by 9.02 inches)		
B5 ISO	176 by 250 mm (6.93 by 9.84 inches)		



Supported paper sizes and weights for the duplexer

Size	Dimensions	Weight
Letter	216 by 279 mm (8.5 by 11 inches)	60 to 105 g/m ² (16 to 28 lb)
A4	210 by 297 mm (8.3 by 11.7 inches)	
Executive	184 by 267 mm (7.3 by 10.5 inches)	
Legal	216 by 356 mm (8.5 by 14 inches)	
B5 (JIS)	182 by 257 mm (7.2 by 10 inches)	

Supported paper sizes and weights for the ADF

Size	Dimensions	Weight
Letter	216 by 279 mm (8.5 by 11 inches)	60 to 135 g/m ² (16 to 36 lb)
A4	210 by 297 mm (8.3 by 11.7 inches)	
Legal	216 by 356 mm (8.5 by 14 inches)	
Custom sizes	Minimum: 148.5 by 210 mm (5.9 by 8.3 inches) Maximum: 215.9 by 355.6 mm (8.5 to 14 inches)	



Supported paper sizes and weights for the ADF (continued)

Size	Dimensions	Weight
Special considerations:		
<ul style="list-style-type: none">• Documents must be free of tears or perforations• Documents must be square or rectangular and in good condition (not fragile or worn)• Documents must be free of glue, correction fluid, or wet ink• Avoid multipart forms.		



Supported paper sizes for the scanner glass

The scanner glass can accommodate:

- letter- or A4-size and smaller originals, books, manuals, receipts, and similar documents.
- irregular and worn documents, stapled documents, and photographs.
- multiple-page letter-size documents.



Supported types of paper

The product supports the following types of paper and other print media:

- plain
- letterhead
- prepunched
- bond
- color
- rough
- user-defined (five types)
- preprinted
- transparency
- labels
- recycled
- card stock
- envelopes



Guidelines for using paper

For best results, use conventional 75 to 90 g/m² (20 to 24 lb) paper. Make sure the paper is of good quality, and free of cuts, nicks, tears, spots, loose particles, dust, wrinkles, voids, and curled or bent edges.

If you are unsure what type of paper you are loading (such as bond or recycled), check the label on the package of paper.

Some paper causes print quality problems, jamming, or damage to the product.

Symptom	Problem with paper	Solution
Poor print quality or toner adhesion.	Too moist, too rough, too smooth, or embossed. Ragged edges. Faulty paper lot.	Try another kind of paper, between 100 to 250 Sheffield, 4 to 6 percent moisture content.
Dropouts, jamming, curl.	Stored improperly.	Store paper flat in its moisture-proof wrapping.
Increased gray background shading.	Too heavy. Too smooth.	Use lighter paper. Open the rear output slot. Use less smooth paper.
Excessive curl. Problems with feeding.	Too moist, wrong grain direction, or short-grain construction.	Open the rear output slot. Use long-grain paper. Store paper in a drier environment.



Note

Do not use letterhead paper that is printed with low-temperature inks, such as those used in some types of thermography.

Do not use raised letterhead.

The product uses heat and pressure to fuse toner to the paper. Make sure that any colored paper or preprinted forms use inks that are compatible with the product's temperature of 230° C (446° F) for 0.05 second.

Avoid using paper that has been damaged by having already been used in a printer or copier. (Do not print on both sides of envelopes, transparencies, or labels.)



Labels

CAUTION

To avoid damaging the product, use only labels recommended for use in laser printers.

If you have problems printing labels, use Tray 1 and open the rear output slot.

Do not print on the same sheet of labels more than once—peeling and adhesive contamination might result.

Label construction

When selecting labels, consider the quality of each component:

- **Adhesives:** The adhesive material should be stable at 230° C (446° F), the product's maximum temperature.
- **Arrangement:** Only use labels with no exposed backing between them. Labels can peel off sheets with spaces between the labels, causing serious jams.
- **Curl:** Prior to printing, labels must lie flat with no more than 13 mm (0.5 inch) of curl in any direction.
- **Condition:** Do not use labels with wrinkles, bubbles, or other indications of separation.

To print sheets of labels, see [“Using labels” on page 27](#).

Transparencies

Transparencies must be able to withstand 230° C (446° F), which is the product's maximum temperature. Print transparencies to the top output bin by closing the rear output slot.

Transparencies can be printed from Tray 1 or Trays 2, 3, or 4. To print transparencies, see [“Using transparencies” on page 27](#). If you experience difficulties, use Tray 1. Make sure you remove each transparency from the output tray when it is printed to prevent sticking.

CAUTION

To avoid damaging the product, use only transparencies recommended for use in laser printers.



Envelopes

Envelope construction

Envelope construction is critical. Envelope fold lines can vary considerably, not only between manufacturers, but also within a box from the same manufacturer. Successful printing on envelopes depends upon the quality of the envelopes.

When selecting envelopes, consider the components listed below. Many envelope manufacturers are now making envelopes optimized for laser printers.

- **Weight:** The weight of the envelope paper should be 75 to 105 g/m² (20 to 28 lb), or jamming may result.
- **Construction:** Prior to printing, envelopes should lie flat with less than 6 mm (0.25 inches) curl, and should not contain air. (Envelopes that trap air may cause problems.)
- **Condition:** Make sure envelopes are not wrinkled, nicked, or otherwise damaged.
- **Sizes in Tray 1:** From 76 by 127 mm (3 by 5 inches) to 216 by 356 mm (8.5 by 14 inches).
- **Sizes in the optional power envelope feeder:** From Monarch (#7¾) (98.4 by 190.5 mm, or 3.88 by 7.50 inches) to B5 (ISO) (176 by 250 mm, or 6.93 by 9.84 inches).



If you do not have an optional power envelope feeder, always print envelopes from Tray 1 (see [“Using envelopes” on page 26](#)). To print envelopes with the optional envelope feeder, see [“Using an optional power envelope feeder” on page 26](#). If envelopes curl, try opening the rear output slot.

Envelopes with double-side seams

Double-side seams with envelopes have vertical seams at both ends of the envelope rather than diagonal seams. This style may be more likely to wrinkle unless properly constructed. Be sure the seam extends all the way to the corner of the envelope.

Envelopes with adhesive strips or flaps

Envelopes with a peel-off adhesive strip or with more than one flap that folds over to seal must use adhesives compatible with the heat and pressure in the product. The extra flaps and strips might cause wrinkling, creasing, or jams.

Envelope margins

The following table gives typical address margins for a commercial #10 or DL envelope.

Type of address	Top margin	Left margin
Return address	15 mm (0.6 inch)	15 mm (0.6 inch)
Delivery address	51 mm (2 inches)	89 mm (3.5 inches)



Note

For the best print quality, position margins no closer than 15 mm (0.6 inch) from the edges of the envelope.

Envelope storage

Proper envelope storage contributes to good print quality. Envelopes should be stored flat. If air is trapped in an envelope, creating an air bubble, the envelope may wrinkle during printing.

Card stock and heavy paper

Many types of card stock can be printed from Tray 1, including index cards and postcards. Some card stock performs better than others because its construction is better suited for feeding through a laser printer.

For optimal product performance, do not use paper heavier than 199 g/m² (53 lb) in Tray 1 or 105 g/m² (28 lb) in other trays. Paper that is too heavy might cause misfeeds, stacking problems, jams, poor toner fusing, poor print quality, or excessive mechanical wear.

Note

Printing on heavier paper may be possible if the tray is not filled to capacity, and short grain paper with a smoothness rating of 100 to 180 Sheffield is used.

Card stock construction

- **Smoothness:** Card stock should have smoothness in the range of 100 to 180 Sheffield.
- **Construction:** Card stock should lie flat with less than 5 mm (0.2 inch) of curl. Short-grain paper improves feeding and reduces wear on the product.
- **Condition:** Make sure card stock is not wrinkled, nicked, or otherwise damaged.
- **Sizes:** Use only card stock within the following size ranges:
 - minimum: 76 by 127 mm (3 by 5 inches)
 - maximum: 216 by 356 mm (8.5 by 14 inches)

Before loading card stock in Tray 1, make sure it is regular in shape and not damaged. Also, make sure the cards are not stuck together.

Card stock guidelines

- If cards curl or jam, try printing from Tray 1 and opening the rear output slot.
- Set margins at least 6 mm (0.24 inch) away from the edges of the paper.



Product specifications

Physical dimensions

1043 mm (41.1 inches)
full-length trays and rear output slot open

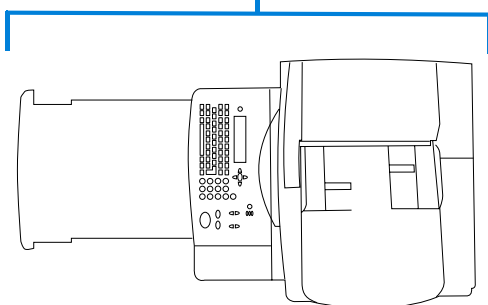

HP LaserJet 4100 mfp
415 mm
(16.4 inches)

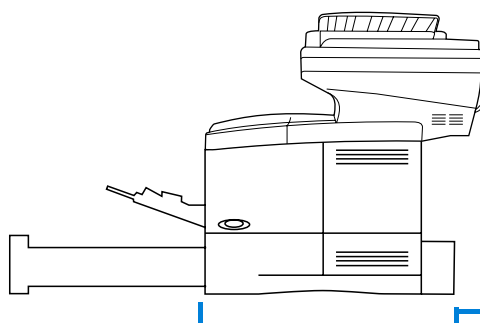

HP LaserJet 4100 mfp
540 mm
(21.25 inches)

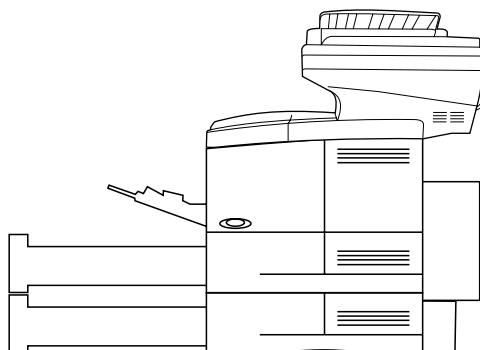

443 mm
(17.5 inches)

HP LaserJet 4101 mfp
or
HP LaserJet 4100 mfp
with optional 500-sheet
tray and duplexer
661 mm
(26 inches)



Product weight (without toner cartridge)

HP LaserJet 4100 mfp	25 kg (55 lb)
HP LaserJet 4101 mfp	36 kg (78.6 lb)
duplexer	3.9 kg (8.6 lb)
500-sheet paper tray	6.8 kg (15 lb)



Environmental specifications

Electrical specifications

The following specifications apply to both the HP LaserJet 4100 mfp and HP LaserJet 4101 mfp.

Printing (continuous)	490 watts
Copying (continuous)	510 watts
Standby	40 watts
PowerSave	40 watts



PowerSave default activation time is 30 minutes.

Note

“Operating” means that the product is copying and printing at 25 ppm. Values are subject to change. See <http://www.hp.com/lj4100mfp> for current information.

Minimum recommended circuit capacity

110 to 127 Volt	8 amps
220 to 240 Volt	4 amps

Power requirements (acceptable line voltage)

110 to 127 Volt	50/60 Hz
220 to 240 Volt	50/60 Hz



Acoustic emissions (per ISO 9296)

Tests per ISO 9296 (ISO 7779)

Device state	LpAm (Operating Position, dB)	LpAm (Bystander Position, dB)	Sound Power LwAd (Bel) ¹
Printing	58	52	6.6
Copying	61	54	6.9
Idle/PowerSave	39	36	5.1



Note

“Operating” means that the product is copying and printing continuously at 25 ppm. Values are subject to change. See <http://www.hp.com/lj4100mfp> for current information.



General specifications

Operating temperature	10 to 32° C (50 to 91° F)
Relative humidity	20 to 80 percent
Print engine speed, in ppm	Up to 25 ppm, letter-size paper Up to 24 ppm, A4-size paper
Copy speed, in ppm	25 ppm, letter-size paper 24 ppm, A4-size paper
ADF	Up to 30 pages Up to legal-size capability
Expandable memory	Up to 256 MB total, combining standard and accessory memory DIMMs



B Ordering information

Available accessories

You can increase the capabilities of your HP LaserJet 4100 mfp series with the optional accessories shown below.

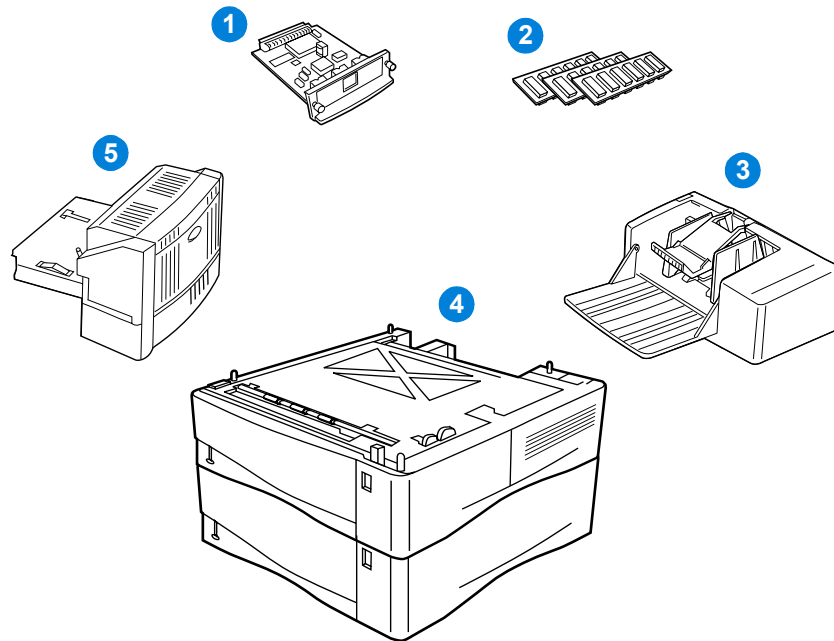

- 1 Alternative HP Jetdirect print server (EIO card)
- 2 Font or RAM DIMM
- 3 75-envelope power envelope feeder
- 4 Stackable 500-sheet media tray (one additional tray standard for HP LaserJet 4101 mfp)
- 5 Duplexer for two-sided printing (standard for HP LaserJet 4101 mfp)



Part numbers

To order a part or accessory for the HP LaserJet 4100 mfp series, contact an HP-authorized service or support provider or use one of the following websites.

- North America:
<https://www.hp.com/go/ordersupplies-na>
- Europe and Middle East:
<https://www.hp.com/go/ordersupplies-emea>
- Asia Pacific:
<https://www.hp.com/go/ordersupplies-ap>
- Latin America:
<https://www.hp.com/go/ordersupplies-la>



Note

Use only parts and accessories specifically designed for this product. The following tables identify available parts and accessories and are organized according to accessory type.

Media handling

Item	Part number	Description or use
500-sheet feeder and media tray	C8055A	Stackable media feeder and 500-sheet media tray
Power envelope feeder	C8053A	Automatically feeds as many as 75 envelopes
Duplexer	C8054A	Allows automatic output on both sides of media
Additional 500-sheet media tray (without feeder)	C8056A	Supports multiple media sizes and custom sizes

Memory, fonts, and mass storage

Item	Part number	Description or use
DIMM		
4 MB	C4140A	Improves the ability of the product to handle large print jobs (maximum of 256 MB when using HP DIMMs)
8 MB	C7842A	
16 MB	C7843A	
32 MB	C7845A	
64 MB	C7846A	
128 MB	C9121A	
Font DIMM		Supports 8-MB Asian MROM
Korean	D4838A	
Simplified Chinese	C4293A	
Traditional Chinese	C4292A	



Hardware

Item	Part number	Description or use
HP Fast InfraRed Connect	C4103A	Fast InfraRed receiver

Cables and interfaces

Item	Part number	Description or use
Parallel cables		For connection to a computer
2-meter IEEE-1284 cable	C2950A	
3-meter IEEE-1284 cable	C2951A	
Macintosh computer serial cable	92215S	For connection to a Macintosh computer
Macintosh network cable kit	92215N	For connection to PhoneNET or LocalTalk
Enhanced I/O (EIO) cards		HP Jetdirect EIO internal print server network cards
Token Ring networks	J4167A	
Fast Ethernet (10/100Base-TX single RJ-45 port)	J4169A	
HP Jetdirect connectivity card (EIO) for USB, serial, and LocalTalk	J4135A	



Documentation

Item	Part number	Description or use
<i>Print Media Guide</i>	5963-7863	A guide to using various paper types and other print media with HP LaserJet printers (English only)
HP LaserJet 4100 mfp series software and user documentation CD-ROM		An additional copy of the software and user documentation CD-ROM
Americas/Western Europe	C8049-60129	
Europe	C8049-60130	
Asia Pacific	C8049-60131	
<i>start</i> guide	C9148-90901 C9148-90902 C9148-90906 C9148-90907 C9148-90908	Printed copy of HP LaserJet 4100 mfp series <i>start</i> guide

Maintenance

Item	Part number	Description or use
Printer maintenance kit		User-replaceable service parts and instructions for product maintenance
110 V printer kit	C8057A	
220 V printer kit	C8058A	



Printing supplies

Item	Part number	Description or use
Toner cartridges		
6,000 pages	C8061A	HP UltraPrecise toner cartridge supplied with product.
10,000 pages	C8061X	Replacement HP UltraPrecise toner cartridge.
HP LaserJet Tough Paper		
Letter (8.5 by 11 inches), 50 sheets/box	Q1298A	For use with HP color LaserJet and HP monochrome LaserJet printing products. A unique paper that will not tear and withstands the weather. Excellent for documents requiring durability and longevity in all weather conditions. Specifications: 5 mil; satin finish.
A4 (216 by 279 mm), 50 sheets/box	Q1298B	
HP LaserJet Soft Gloss Paper		
Letter (8.5 by 11 inches), 50 sheets/box	C4179A	For use with HP Color LaserJet printers and HP LaserJet monochrome printers. Coated media, good for business documents with high impact, such as brochures, sales material, and documents with graphics and photographic images. Specifications: 85 bright, 32 lb.
A4 (216 by 279 mm), 50 sheets/box	C4179B	
HP LaserJet Transparency		
Letter (8.5 by 11 inches), 50 sheets/box	92296T	For use with HP LaserJet monochrome printers. Specifications: 4.3 mil thickness.
A4 (216 by 279 mm), 50 sheets/box	92296U	
HP Premium Choice LaserJet Paper		
Letter (8.5 by 11 inches), 500 sheets/ream, 10-ream carton	HPU1132	For use with HP Color LaserJet printers, HP LaserJet monochrome printers, and color copiers. Good for hardcopy presentations, business reports and proposals, data sheets, price lists, and newsletters. Specifications: 98 bright, 32 lb.
A4 (216 by 279 mm), 500 sheets/ream, 4-ream carton	CHP410	
A4 (216 by 279 mm), 250 sheets/ream, 8-ream carton	CHP415	
HP LaserJet Paper		
Letter (8.5 by 11 inches), 500 sheets/ream, 10-ream carton	HPJ1124	For use with HP color LaserJet and HP LaserJet monochrome products. Good for letterhead, high-value memos, legal documents, direct mail, and correspondence. Specifications: 96 bright, 24 lb.
Letter (8.5 by 11 inches), 3-hole, 500 sheets/ream, 10-ream carton	HPJ113H	
Legal (8.5 by 14 inches), 500 sheets/ream, 10-ream carton	HPJ1424	
A4 (216 by 279 mm), 500 sheets/ream, 5-ream carton	CHP310	
HP Printing Paper		
Letter (8.5 by 11 inches), 500 sheets/ream, 10-ream carton	HPP1122	For use with laser and inkjet products, especially for small and home offices. Heavier and brighter than copier paper. Specifications: 92 bright, 22 lb.
A4 (216 by 279 mm), 500 sheets/ream, 5-ream carton	CHP210	



Printing supplies (continued)

Item	Part number	Description or use
HP Multipurpose Paper Letter (8.5 by 11 inches), 500 sheets/ream, 10-ream carton	HPM1120	For use with all office equipment—laser and inkjet printers, copiers, and fax machines. For businesses that prefer to use one paper for all their office needs. Brighter and smoother than other office papers. Specifications: 90 bright, 20 lb.
Letter (8.5 by 11 inches), 500 sheets/ream, 5-ream carton	HPM115R	
Letter (8.5 by 11 inches), 250 sheets/ream, 12-ream carton	HP25011	
Letter (8.5 by 11 inches), 3-hole, 500 sheets/ream, 10-ream carton	HPM113H	
Legal (8.5 by 14 inches), 500 sheets/ream, 10-ream carton	HPM1420	
HP Office Paper Letter (8.5 by 11 inches), 500 sheets/ream, 10-ream carton	HPC8511	
Letter (8.5 by 11 inches), 3-hole, 500 sheets/ream, 10-ream carton	HPC3HP	
Legal (8.5 by 14 inches), 500 sheets/ream, 10-ream carton	HPC8514	
Letter (8.5 by 11 inches), Quick Pack, 2,500-sheet carton	HP2500S	
A4 (216 by 279 mm), 500 sheets/ream, 5-ream carton	CHP110	
HP Office Recycled Paper Letter (8.5 by 11 inches), 500 sheets/ream, 10-ream carton	HPE1120	For use with all office equipment—laser and inkjet printers, copiers, and fax machines. Good for high-volume printing. Satisfies U.S. Executive Order 13101 for environmentally preferable products. Specifications: 87 bright, 20 lb, 30 percent post-consumer content.
Letter (8.5 by 11 inches), 3-hole, 500 sheets/ream, 10-ream carton	HPE113H	
Legal (8.5 by 14 inches), 500 sheets/ream, 10-ream carton	HPE1420	





C Regulatory information

FCC regulations

The HP LaserJet 4100 mfp series has been tested and found to comply with the limits for a Class A digital device, pursuant to Part 15 of the FCC rules. These limits are designed to provide reasonable protection against harmful interference in a residential installation. This equipment generates, uses, and can radiate radio frequency energy. If this equipment is not installed and used in accordance with the instructions, it may cause harmful interference to radio communications. However, there is no guarantee that interference will not occur in a particular installation. If this equipment does cause harmful interference to radio or television reception, which can be determined by turning the equipment off and on, the user is encouraged to try to correct the interference by one or more of the following measures:

- Reorient or relocate the receiving antenna.
- Increase separation between equipment and receiver.
- Connect equipment to an outlet on a circuit different from that to which the receiver is located.
- Consult your dealer or an experienced radio/TV technician.

Note

Any changes or modifications to the product that are not expressly approved by HP could void the user's authority to operate this equipment.

Use of a shielded interface cable is required to comply with the Class A limits of Part 15 of FCC rules.



Environmental product stewardship program

Protecting the environment

HP is committed to providing quality products in an environmentally-sound manner. HP products have been designed with several attributes to minimize impacts on the environment.

This HP LaserJet product eliminates:

- **Ozone production**

The product uses charging rollers in the electrophotographic process and therefore generates no appreciable ozone gas (O₃).

This HP LaserJet product design reduces:

- **Energy consumption**

Energy usage drops significantly while in PowerSave mode, which saves natural resources and saves money without affecting the high performance of this product. This product qualifies for ENERGY STAR[®], which is a voluntary program established to encourage the development of energy-efficient office products.



ENERGY STAR[®] is a U.S. registered service mark of the U.S. EPA. As an ENERGY STAR[®] partner, Hewlett-Packard Company has determined that this product meets ENERGY STAR[®] Guidelines for energy efficiency. For more information, see <http://www.energystar.gov>.

- **Toner consumption**

EconoMode uses significantly less toner, which might extend the life of the toner cartridge.

- **Paper use**

Depending on the type of software program in use, you can request that a number of pages of your document be printed on one sheet of paper. This N-up printing practice and the product's automatic duplexing feature, which provides two-sided printing, can reduce paper usage and the resulting demands on natural resources.

This HP LaserJet multifunction product also contributes to protecting the environment in the following ways:

- **Plastics marking for recycling**

Plastic parts over 25 grams have markings according to international standards that enhance the ability to identify plastics for recycling purposes at the end of the product's life.

- **HP LaserJet printing supplies**

In many countries, printing supplies (for example, toner cartridge, drum, and fuser) can be returned to HP through the HP Printing Supplies Returns and Recycling Program. An easy-to-use and free takeback program is available in more than 48 countries. Multilingual program information and instructions are included in every new HP LaserJet toner cartridge and consumables package.

- **HP printing supplies returns and recycling program information**

Since 1990, the HP Printing Supplies Returns and Recycling Program has collected more than 47 million used LaserJet toner cartridges that otherwise might have been discarded in the world's landfills. Cartridges and consumables are collected and bulk-shipped to HP's resource and recovery partners who disassemble the



cartridges. After a thorough quality inspection, selected parts are reclaimed for use in new cartridges. Remaining materials are separated and converted into raw materials for use by other industries to make a variety of useful products.

- **U.S. returns**

For a more environmentally responsible return of used cartridges and consumables, HP encourages the use of bulk returns. Simply bundle two or more cartridges together and use the single, pre-paid, pre-addressed UPS label that is supplied in the package. For more information in the U.S., call (800) 340-2445, or visit the HP LaserJet Supplies web site <http://www.hp.com/go/recycle>.

- **Non-U.S. returns**

Non-U.S. customers should call their local HP sales and service office or visit the following web site for further information regarding availability of the HP Supplies Returns and Recycling Program: <http://www.hp.com/go/recycle>.

- **Recycled paper**

This product is suited for the use of recycled papers when the paper meets the guidelines outlined in the *Print Media Guide*. See “[Ordering information](#)” on [page 125](#) to order the guide. This product is suitable for the use of recycled paper according to DIN 19309.

- **Battery use**

This product does not contain batteries.

- **Mercury use**

Mercury has not been deliberately added to this product.

To ensure longevity of this multifunction product, HP provides the following:

- **Extended warranty**

HP SupportPack provides coverage for HP hardware and all HP-supplied internal components. The hardware maintenance covers a three-year period from date of the HP product purchase. The customer must purchase HP SupportPack within 90 days of product purchase. See “[HP customer care service and support](#)” on [page 107](#) for information on its availability.

- **Spare parts and consumables availability**

Spare parts and consumable supplies for this product will be made available for at least 5 years after production has stopped.

Material safety data sheets

Material safety data sheets (MSDS) can be obtained by contacting the HP LaserJet Supplies web site at http://www.hp.com/hpinfo/community/environment/pr_prodsafe.htm.



Declaration of Conformity

according to ISO/IEC Guide 22 and EN 45014

Manufacturer's Name: Hewlett-Packard Company
Manufacturer's Address: 11311 Chinden Boulevard
Boise, Idaho 83714-1021, USA

declares that the product

Product Name: HP LaserJet 4100mfp series; HP LaserJet 4101mfp
Model Numbers: C9148A (4100); C9149A (4101)
Product Options: ALL

conforms to the following Product Specifications:

Safety: IEC 60950:1991+A1+A2+A3+A4 / EN 60950:1992+A1+A2+A3+A4+A11
IEC 60825-1:1993 +A1 / EN 60825-1:1994 +A11 Class 1 Laser/LED Product
EMC: CISPR22:1993 +A1 +A2 / EN 55022:1994 +A1 +A2 Class A¹
EN 61000-3-2:1995 +A14:2000
EN 61000-3-3:1995
EN 55024: 1998
FCC Title 47 CFR, Part 15 Class A² / ICES-003, Issue 3
AS / NZS 3548:1995

Supplementary Information:

The product herewith complies with the requirements of the EMC Directive 89/336/EEC and the Low Voltage Directive 73/23/EEC, and carries the CE-Marking accordingly:

1. The product was tested in a typical configuration with Hewlett-Packard Personal Computer Systems.
2. This Device complies with Part 15 of the FCC Rules. Operation is subject to the following two Conditions: (1) this device may not cause harmful interference, and (2) this device must accept any interference received, including interference that may cause undesired operation.

WARNING! This is a Class A product. In a domestic environment this product may cause radio interference, in which case the user may be required to take adequate measures.

Boise, Idaho, USA
April 2, 2001

For regulatory topics ONLY, contact:

Australia Contact: Product Regulations Manager, Hewlett-Packard Australia Ltd.,
31-41 Joseph Street, Blackburn, Victoria 3130, Australia
European Contact: Your Local Hewlett-Packard Sales and Service Office or Hewlett-Packard GmbH, Department HQ-TRE / Standards Europe,
Herrenberger Straße 110-140, D-71034 Böblingen (FAX: +49-7031-14-3143)
USA Contact: Product Regulations Manager, Hewlett-Packard Company, PO
Box 15, Mail Stop 160, Boise, ID 83707-0015 (Phone: (208) 396-6000)



Safety statements

Laser safety statement

The Center for Devices and Radiological Health (CDRH) of the U.S. Food and Drug Administration has implemented regulations for laser products manufactured since August 1, 1976. Compliance is mandatory for products marketed in the United States. The product is certified as a “Class 1” laser product under the U.S. Department of Health and Human Services (DHHS) Radiation Performance Standard according to the Radiation Control for Health and Safety Act of 1968. Since radiation emitted inside the product is completely confined within protective housings and external covers, the laser beam cannot escape during any phase of normal user operation.



WARNING!

Using controls, making adjustments, or performing procedures other than those specified in this user guide may result in exposure to hazardous radiation.

Canadian DOC regulations

Complies with Canadian EMC Class A requirements.

«Conforme à la classe A des normes canadiennes de compatibilité électromagnétiques. «CEM».»

VCCI statement (Japan)

この装置は、情報処理装置等電波障害自主規制協議会（VCCI）の基準に基づきクラスA情報技術装置です。この装置を家庭環境で使用すると電波妨害を引き起こすことがあります。この場合には使用者が適切な対策を講ずるよう要求されることがあります。

This equipment is in the Class A category information technology equipment based on the rules of Voluntary Control Council for Interference by Information Technology Equipment (VCCI). When used in a residential area, radio interference may be caused. In this case, the user may be required to take appropriate corrective actions.



Laser statement for Finland

Luokan 1 laserlaite

Klass 1 Laser Apparat

HP LaserJet 4100 mfp series laserkirjoitin on käyttäjän kannalta turvallinen luokan 1 laserlaite. Normaalisissa käytössä kirjoittimen suojakotelointi estää lasersäteen pääsyn laitteen ulkopuolelle. Laitteen turvallisuusluokka on määritetty standardin EN 60825-1 (1994) mukaisesti.



Varoitus!

Laitteen käyttäminen muulla kuin käyttöohjeessa mainitulla tavalla saattaa altistaa käyttäjän turvallisuusluokan 1 ylittävälle näkymättömälle lasersäteilylle.



Varning!

Om apparaten används på annat sätt än i bruksanvisning specificerats, kan användaren utsättas för osynlig laserstrålning, som överskrider gränsen för laserklass 1.



HUOLTO

HP LaserJet 4100 mfp series kirjoittimen sisällä ei ole käyttäjän huollettavissa olevia kohteita. Laitteen saa avata ja huoltaa ainoastaan sen huoltamiseen koulutettu henkilö. Tällaiseksi huoltotoimenpiteeksi ei katsota väriainekasetin vaihtamista, paperiradan puhdistusta tai muita käyttäjän käsikirjassa lueteltuja, käyttäjän tehtäväksi tarkoitettuja ylläpitotoimia, jotka voidaan suorittaa ilman erikoistyökaluja.

Varo!

Mikäli kirjoittimen suojakotelo avataan, olet alltiina näkymättömälle lasersäteilylle laitteen ollessa toiminnassa. Älä katso säteeseen.

Varning!

Om laserprinterns skyddshölje öppnas då apparaten är i funktion, utsättas användaren för osynlig laserstrålning. Betrakta ej strålen.

Tiedot laitteessa käytettävän laserdiodin säteilyominaisuuksista:

Aallonpituus 775-795 nm
Teho 5 mW
Luokan 3B laser



D System administrator guide

Overview

This portion of the Use guide provides important information for the system administrator who sets up, configures, and maintains the hp LaserJet 4100 mfp series. General topics include the following:

- using the embedded Web server
- configuring and verifying a TCP/IP address
- establishing multitasking (contention management) priorities
- using e-mail settings
- using the embedded Web server with HP Web JetAdmin
- replacing or adding a DIMM
- handling printer commands



Using the embedded Web server

A Web server provides an environment in which Web programs can run. The output from these programs can then be displayed by a Web browser, such as Microsoft Internet Explorer or Netscape Navigator. The embedded Web server allows you to display status information, change settings, and manage the product from your computer.

The embedded Web server is an integral component of the product hardware and does not need to be installed separately. It functions by establishing an Internet connection to the MFP's home page when you enter the MFP's IP address using a standard browser.

The embedded Web server requires only a connection to the network, which is provided through the product's integral hp Jetdirect network card.

From the HP LaserJet 4100 mfp series home page, you can set or obtain information about the product, such as:

- control panel messages.
- consumable levels.
- tray configuration.
- product control panel menu configuration.
- product configuration page.
- product event log.
- types of print jobs processed.
- network information.

You can also use the embedded Web server to perform any job management functions that are usually done at the control panel. These functions could include:

- changing product settings.
- setting and changing product configuration.
- diagnosing and troubleshooting problems.
- canceling copy or print jobs.

System requirements

To use the HP embedded Web server, you need:

- a TCP/IP-based network.
- a Web browser installed on your computer, preferably either Netscape Navigator 4.7x or Microsoft Internet Explorer 5.0x and above.

Note

You can gain access to the embedded Web server from any operating system that supports the TCP/IP protocol and a Web browser. Parallel cable connections and IPX-based network printer connections are not supported. You cannot view the embedded Web server pages from outside a firewall.

Restricting remote configuration

The HP LaserJet 4100 mfp series allows four levels of security. Once system defaults are set, you can lock the defaults by using password protection to ensure that the defaults are not inadvertently changed by a user.



Reaching the embedded Web server

You can reach the product's home page through the embedded Web server by entering the product's IP address, or through HP Web JetAdmin.

Note

HP Web JetAdmin is not included in the product installation software, but can be downloaded from the HP Web site at <http://www.hp.com/go/webjetadmin>.

In the embedded Web server, you can:

- set up a support contact and support URLs.
- set up a password to control who can remotely access the networking pages.
- view general network status information, including network statistics stored on the print server.



Configuring and verifying an IP address



TCP/IP addresses can be assigned and configured on an HP Jetdirect print server using several options:

- HP Web JetAdmin
- HP JetAdmin for Windows
- embedded Web server

TCP/IP assignment

The system administrator or primary user is responsible for determining the TCP/IP address for a specific print server. If you are unsure what the TCP/IP address should be or if you are unfamiliar with using TCP/IP on a network, go to the HP Web site at <http://www.hp.com>. Click Search in the upper left corner of the Web page and search for TCP/IP Overview.

Automatic discovery

The HP LaserJet 4100 mfp series is equipped with an HP Jetdirect network card. All HP Jetdirect print servers have a default TCP/IP address of 192.0.0.192. During product installation, your network server will automatically update the default HP IP address to an address available for use on your network. To determine the new system IP address, print a configuration page and check the TCP/IP status and address.

Dynamic Host Configuration Protocol (DHCP)

When the HP LaserJet 4100 mfp series is turned on, the HP Jetdirect print server broadcasts DHCP requests. DHCP automatically downloads an IP address from a network server. DHCP servers maintain a fixed set of IP addresses and only loan an IP address to the print server. Consult your operating system documentation to set up DHCP service on your network.



Verifying the TCP/IP configuration

Print a configuration page from the control panel or the external print server. Check the TCP/IP status and the TCP/IP addresses. If the information is incorrect, check your hardware connections (cables, hubs, routers, or switches) or recheck the validity of the TCP/IP address.

Changing an IP address

Use the following procedures if you have to change the product's TCP/IP address for any reason.

HP Web JetAdmin

Open HP Web JetAdmin. Enter the TCP/IP address in the Quick Device Search, and click [Go](#). At the top menu bar, follow this procedure for discovery options.

- 1 Choose the drop-down menu and click **Devices**.
- 2 From the drop-down menu, click **New Devices**. Click [Go](#).
- 3 Click the column header of your choice (such as IP Address or Device Model) to arrange the list of available devices in ascending or descending order.
- 4 Highlight the product to configure, and click **Open Device**.
- 5 From the sub-menu at the top of the HP Web JetAdmin screen, click **Configuration**.
- 6 Click the network link located on the left side of the configuration screen.
- 7 Enter the new IP information. You might have to scroll down for more options.
- 8 Click **Apply** to save the settings.
- 9 Click the **Refresh** button located next to the question mark on the right side of the screen.
- 10 Verify the IP information by clicking **Status Diagnostics** or by printing a configuration page.



Embedded Web server

The HP LaserJet 4100 mfp series has an embedded Web server that can be used to modify the TCP/IP parameters. To use the embedded Web server, the HP Jetdirect print server must have an IP address already configured. On a network, this is done automatically during initial product installation.

- Using a supported Web browser, enter the current IP address of the HP Jetdirect print server as the URL.
- The HP Jetdirect main Web page will appear. Click **Administration**. From this page, you can modify the TCP/IP addresses and, if necessary, the community name.



Configuring multitasking priorities

The HP LaserJet 4100 mfp series allows processing of several jobs simultaneously. System defaults are set to give the walk-up user priority over jobs coming in over the network.

The user can send digital documents while the MFP is printing. If a print job is in progress, the MFP scans in the originals and waits to begin copying until printing is complete, or, if the print job is a collated copy job, until the next collated set is complete. All other print jobs in the queue will be held until the copy job is completed. If a print job is sent while copying is underway, printing will be delayed until the job is finished.

System default multitasking priorities can be changed either at the control panel or through the embedded Web server. Use these components of the System Setup menu to change the system defaults.



Scan ahead submenu

This menu item allows the administrator to enable or disable the scan ahead feature. Scan Ahead allows a copy job to be scanned and saved to disk for later printing if the print engine is currently busy with another job.

- ON - A copy job scan will start immediately, even if a network print job or another copy job is currently printing. Scanned images are held on the MFP disk until they are printed.
- OFF - A scan copy job cannot commence until the MFP is in Ready state. In essence, the user can't start scanning unless printing of the copy job can start immediately.

Auto job interrupt submenu

This menu item enables or disables the automatic interruption of a currently printing network print job at a copy boundary in order to print a copy job.

- ON - A copy job will begin and will interrupt a print job on a copy boundary. Once copying is finished, the print job will resume.
- OFF - A copy job will begin processing following completion of the current print job.

Copy job interrupt submenu

This menu item enables or disables the automatic interruption of a current copy job on a copy boundary in order to print another copy job from the scanner glass or the ADF.

- ON - If a user walks up to the device and presses the **START** key while the current copy job is underway, this job will be interrupted on a copy boundary to allow the priority copy job to proceed. Once that priority copy job is finished, the previous copy job will resume.
- OFF - If a user walks up to the device and presses the **START** key while a prior copy job is in progress, the newer copy job will not be printed until the previous job is complete.



Hold off print job submenu

This option permits the administrator to determine whether or not network print jobs should be prevented from printing for a certain period of time after completion of a copy job, or if the control panel is accessed. When this option is ON, a walk-up user is given control of the MFP and is allowed a specified period of time to make a copy or send an e-mail. If this option is OFF, a print job can begin immediately after a copy job is completed, requiring that the user wait for a copy or job boundary before the second copy job can be processed.

- ON - Any new control panel activity will suppress an incoming print job within the designated period of time, based on the assumption that the user wishes to copy or send a job. Printing starts immediately after the copy or send job is complete.
- OFF - An incoming print job is processed immediately, even if a walk-up user has already placed their originals and is ready to press the **START** key.

The Hold Off Time submenu allows the administrator to specify the period of time before a print job begins.



Reset copy timeout submenu

This option allows the system administrator to define the period of time that must pass, after any control panel activity, before the copy settings revert to their defaults. The default timeout value is 60 seconds.

Reset send timeout submenu

This timeout option defines the administrator to define the period of time that must pass, after any control panel activity, before the digital-sending settings revert to their defaults. The default timeout value is 60 seconds.



Using digital-sending settings

The digital-sending settings page of the embedded Web server allows you to configure e-mail settings for outgoing and incoming mail. This enables you to use “send and receive” capabilities. Through this page, you can:

- enable and disable the digital-sending service and establish a maximum file size.
- set the SMTP address for digital-sending.
- set an alias to be displayed in the **From** field to replace the full e-mail address.
- set the default **Subject** field.
- use advanced features:
 - establish fixed default **Message Text**.
 - establish default document settings.



Note

Scanned documents are sent as attachments to e-mail.

- test digital-sending settings using the screen’s **Test** button.

LDAP addressing settings

The LDAP addressing settings:

- enable and disable an internal address book.
- establish LDAP parameters to allow access to a centralized network address book.
- enable the **Test** button to verify configuration.

Preferences settings

The Preferences settings:

- set default scanner settings:
 - default document size.
 - default document type: text, mixed or photo.
 - two-sided page.
- set administrator contact information to allow notification of errors that require your attention.



Using HP Web JetAdmin with the embedded Web server

The HP LaserJet 4100 mfp series is fully supported by HP Web JetAdmin, a browser-based management tool typically installed on a network to manage multiple HP products remotely. This tool is generally intended for use by the system administrator.

HP Web JetAdmin can be reached through any supported Web browser (such as Microsoft Internet Explorer 5.0x or Netscape Navigator 4.0x or later) by browsing to the hp Web JetAdmin home page at <http://www.hp.com/go/webjetadmin>.

Use hp Web JetAdmin to do the following:

- Install and configure any product that is connected to a network with an hp Jetdirect print server. When installed on a supported Microsoft host system, hp Web JetAdmin can configure Novell NetWare parameters on the hp Jetdirect print server and NetWare server.
- Manage and troubleshoot networked products from any location.



Configuring product alerts

You can use either the embedded Web server or HP Web JetAdmin to configure the system to alert you of problems with the product. The alerts take the form of e-mail messages and are sent to the e-mail account or accounts that you specify.

You can specify:

- the product that you want to monitor (in this case, the MFP).
- what alerts are to be received (for example, alerts for jams, paper out, toner low, toner out, cover open, scanning or sending errors).
- the e-mail account to which the alerts should be forwarded.

For information about using HP Web JetAdmin to configure product alerts, see:

- “Using HP Web JetAdmin with the embedded Web server” on page 144 for general information about HP Web JetAdmin.
- HP Web JetAdmin Help for details on alerts and alert configuration.

For information about the embedded Web server, see these sources:

- “Using the embedded Web server” on page 138 for general information about the embedded Web server.
- embedded Web server Help.



Installing a DIMM

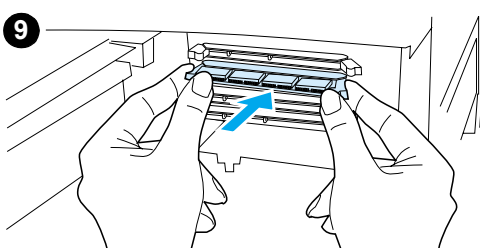
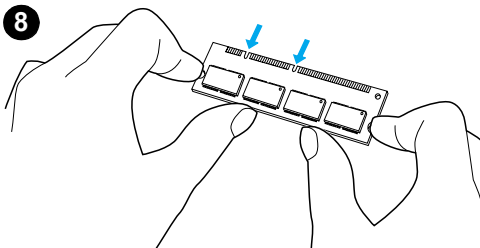
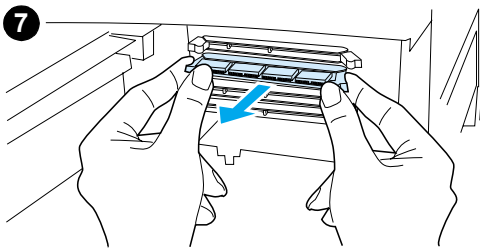
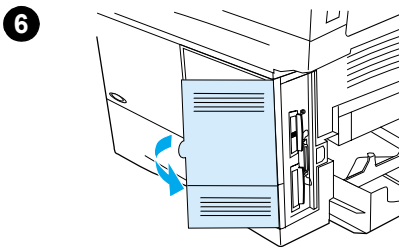
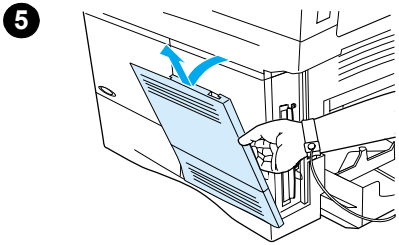
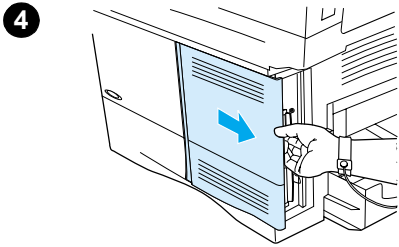

CAUTION

Static electricity can damage DIMMs. When handling DIMMs, either wear an antistatic wrist strap or frequently touch the surface of the DIMM's antistatic package, and then touch bare metal on the product.

- 1 Print a menu map and configuration page before starting this procedure.

Note

This information will be used after installation to ensure that all stored values remain intact.

- Press **MENU** until the **INFORMATION** menu appears.
- Press the Down navigation button until **PRINT MENU MAP** appears.
- Press **✓** to print the page.
- Repeat these steps to select and print the configuration page.

- 2 Turn the product off.
- 3 Unplug the power cord and disconnect any cables.
- 4 Remove the formatter cover by pulling it firmly toward the back of the product until the cover stops.
- 5 Remove the cover from the product.
- 6 Open the DIMM access door by pulling on the large metal tab.
- 7 If you are installing a new firmware DIMM, open the bottom DIMM slot, release the locks and remove the existing firmware DIMM. If you are adding a new font or memory DIMM, open any of the three upper DIMM slots.
- 8 Remove the new DIMM from the antistatic package. Hold the DIMM with your fingers against the side edges and your thumbs against the back edge. Align the notches on the DIMM with the DIMM slot. (Make sure that the locks on each side of the DIMM are open, or outward.)
- 9 Press the DIMM straight into the appropriate slot. Press firmly. Make sure that the locks on each side of the DIMM snap inward into place.

Continued on the next page.



10

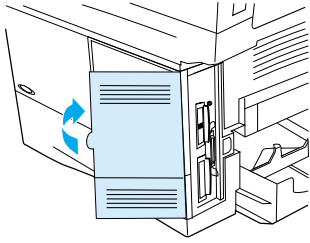

10 Close the DIMM access door. Make sure that it locks into place.

11

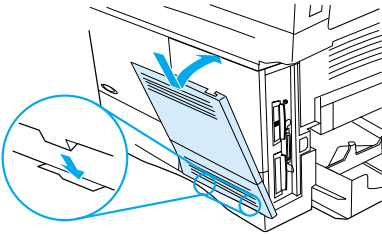

11 Insert the bottom of the cover into the slot and rotate the cover upward.

12

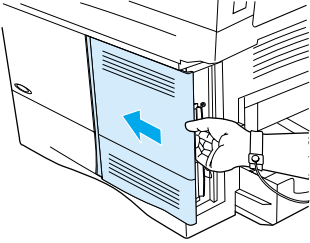

12 Slide the cover toward the front of the MFP until the cover clicks into place. Plug in the power cord, reconnect all cables, and turn the MFP on.

13 Follow this procedure to verify that the DIMM is installed correctly:

- Check that the control panel shows `READY`. If an error message appears, the DIMM might have been incorrectly installed. Review the installation if necessary. See [“Understanding control panel messages” on page 86](#) for more information.
- Print a new menu map and configuration page and compare the new menu map to the map that you printed out before the DIMM installation. If any values are different, make the appropriate changes in the affected menus.
- Compare the new configuration page with the one that you printed earlier.





Note

If you installed a new firmware DIMM, the Firmware Datacode listed in the upper-left block of the page should have been updated to reflect the DIMM replacement. If any values are different and cannot be changed using the menus, call for support.



Understanding printer commands

Most software programs do not require you to enter printer commands. See your computer and software documentation to find the method for entering printer commands, if needed.

PCL 5e	PCL 5e printer commands tell the printer which tasks to perform or which fonts to use.	
HP-GL/2	The printer has the ability to print vector graphics using the HP-GL/2 graphics language. Printing in the HP-GL/2 language requires that the printer leave PCL 5e language and enter HP-GL/2 mode, which can be done by sending the printer PCL 5e code. Some software programs switch languages through their drivers.	
PJL	HP's Printer Job Language (PJL) provides control above PCL 5e and other printer languages. The four major functions provided by PJL are: printer language switching, job separation, printer configuration, and status readback from the printer. PJL commands might be used to change printer default settings.	

For additional information, refer to <http://www.hp.com>.





Index

Symbols

- # (pound sign) key 34
- .jpeg file type 39, 52
- .pdf file type 39, 52
- .tif file type 52
- ? button 34, 42

Numbers

- 100-sheet paper tray. *See* tray 1
- 2-sided printing. *See* duplexing
- 2-up printing 62
- 3-hole punched paper 30
- 500-sheet paper tray
 - bad connection message 86
 - illustration 17
 - orienting paper for duplexing 30
 - orienting special paper 25

A

- A4 paper
 - adjusting printable area 39
 - setting defaults 39
 - supported sizes and weights 114
- access denied menus locked message 86
- accessing print cartridge 17
- accessories
 - list and illustration 125
 - part numbers 126
- acoustic emissions 124
- Acrobat
 - Reader 8
 - using documents 7
 - website 9
- address books
 - clearing 42
 - using 53
- address lists on e-mail server 53
- addresses for gateways 39
- ADF (automatic document feeder)
 - calibrating 42
 - clearing jams 84
 - misfeeding 102
 - testing
 - hardware 42
 - using 20
- adhesive
 - on envelopes 120
 - on labels 119
- adjusting
 - trays 63
 - See also* changing
- administrator. *See* system administrator
- Adobe Acrobat
 - Reader 8
 - using documents 7
 - website 9
- agreements for service 107
- alerts
 - configuring 76
 - system administrator 143
- Apple LaserWriter printer driver 60
- Apple Mac OS printer driver 57
- arrow buttons on control panel 34

- assigning a zone on the network 60
- Attention light 34
- authorized resellers 107
- auto cleaning 40
- AutoCAD printer drivers 57
- auto-continue error, setting default 41
- automatic cleaning for printer 40
- automatic document feeder (ADF). *See* ADF (automatic document feeder)
- autoselect process 63

B

- back page, inserting blank 62
- background, removing 39
- bad duplexer connection message 86
- benefits of product 13
- binding
 - on left or right side 61
 - options for duplexing 31
- bins. *See* output bins; rear output bin; top output bin
- black and white
 - copying 44
 - scan preference 39
- black printing with white spots 101
- blank back page, inserting 62
- booklets 61
- both sides, printing. *See* duplexing
- brightness, increasing for copies 34
- browsers to use for embedded Web server 138
- browsing with thumbnails in online guide 9
- bundles for product configuration 12
- buttons on control panel 34

C

- C button 34
- calibrating the scanner 42
- Canada DOC regulations 135
- canceling jobs
 - using control panel 34
 - using embedded Web server 138
- capacity
 - circuit 123
 - envelope feeder 116
 - Tray 1 114
- card stock
 - printing 28
 - specifications 121
- carriage on scanner, locking 42
- cartridges. *See* print cartridges
- cassette mode 63
- CD
 - for HP Support Assistant 107
 - for service parts information 107
- CFC usage 132
- changing
 - control panel messages 60
 - copy contrast 48
 - copy quality 48
 - defaults using printer commands 147
 - document settings 36
 - printer driver settings 59
 - product settings 60
 - settings using embedded Web server 138



characters misformed 100
 check button 34
 checking toner level 70
 chlorofluorocarbons 132
 choosing appropriate printer driver 59
 circuit capacity 123
 cleaning
 fuser automatically 73
 fuser manually 73
 paper path 73
 printer automatically 40
 product 71
 toner from clothing 72
 cleaning page 40, 73
 Clear button 34
 clearable warnings, setting default 41
 clearing
 address books 42
 event log 42
 persistent messages 86
 clearing jams
 from ADF (automatic document feeder) 84
 from duplexer 81
 from fuser area 83
 from input tray areas 80
 from output area 82
 from top cover and print cartridge areas 79
 locating source 78
 messages on control panel 78
 occurring repeatedly 85
 clipped margins 103
 clothing, cleaning toner from 72
 collating (mopying)
 factory defaults 47
 messages 86
 setting defaults 39
 using 61
 color
 scan preference 39
 scanning and sending 49
 setting 51
 commands for printer
 HP-GL/2 147
 PCL 147
 PJL 147
 compact disc
 for HP Support Assistant 107
 for service parts information 107
 configuration bundles available for product 12
 configuration page
 for product 37
 in embedded Web server 138
 Configure Device menu 39
 configuring
 alerts 76
 control panel messages 60
 e-mail settings 143
 LDAP 143
 networked products remotely 18
 Novell NetWare parameters 144
 password 60
 printer drivers 59
 printer for IP printing 60
 printers connected to network with HP Jetdirect print server 144
 product 10, 137
 scanner defaults 143
 SMTP address for e-mail 143
 support contact URLs 139
 connecting embedded Web server 138
 connections, testing gateway 39
 conserving power, paper, and toner 132
 consumables. *See* supplies
 consumption of power 123
 contact information for system administrator 143
 contact URLs, configuring 139
 contrast, setting default 39
 control panel
 buttons 34
 changing settings for copying 46
 clearing jam messages 78
 configuration information 138
 configuring messages 60
 Copy Settings screen 36, 46
 Describe Original screen 36
 description 33, 34
 features 34
 layout 34
 lights 34
 locking functions 60
 menu map 37
 messages 86
 navigating 35
 Pause/Resume 37
 screens 36
 Send Options screen 36
 status bar 35
 testing hardware 42
 control panel menus
 Configure Device 39
 description 33, 37
 Diagnostics 42
 I/O 41
 Information 37
 Paper Handling 38
 Pause/Resume 37
 Print Quality 40
 reaching 37
 Resets 42
 Retrieve Job 37
 Service 42
 System Setup 41
 copy count 35
 copy jobs. *See* jobs
 Copy Settings screen 36, 46
 copying
 basic procedures 44
 both sides 47
 changing contrast 48
 changing quality 48
 default settings 44
 delaying current job 32
 description 13, 43
 in color 49
 increasing and decreasing image brightness 34
 making a single copy 44
 making multiple copies 44
 one-touch 44
 reducing and enlarging 48
 setting defaults 39
 setting parameters 46
 setting timeout 41
 using other than defaults 45
 using user-defined settings 45
 count
 copies 35
 pages, resetting 42
 Courier
 fonts printing as 103
 selecting which font version 39
 setting default 39
 creased paper 101
 crooked page 100



- curled
 - envelopes 120
 - paper 100, 118, 120
- customer support
 - fraud hotline 108
 - HP SupportPacks 107
 - language and in-country options 108
 - online product information 107
 - online services 107
 - parts information 107
 - sales and service offices worldwide 112
 - service agreements 107
 - worldwide support options 108
- customizing
 - Tray 1 operation 63
 - trays used for printing 63
 - See also configuring
- custom-size paper
 - guidelines for printing 28
 - margins 28
 - printing 28
 - printing to rear output bin 22
 - setting defaults 39
 - setting paper size 28
 - weights and sizes supported for Tray 1 114
- cut-off margins 103

D

- dark button on control panel 34
- Data light 34
- Declaration of Conformity (DOC)
 - Canadian 135
 - U.S. 134
- decreasing
 - copy image brightness 34
 - page view in PDF document 8
- defaults
 - A4 width 39
 - changing using printer commands 147
 - clearable warnings 41
 - contrast 39
 - copy collation 47
 - copy settings 44
 - custom paper size 39
 - device 39
 - duplexing 39
 - e-mail settings 143
 - I/O timeout 41
 - jam recovery 41
 - job storage limit 41
 - jobs 41
 - language 41
 - locking 138
 - manual feed 39
 - number of copies for standard print job 39
 - originals 39
 - paper 39
 - personality 41
 - PowerSave activation time 41, 123
 - printer driver 59
 - printing 39
 - product 39
 - PS error page 39
 - resolution 40
 - scanner settings 143
 - sending 39
 - system setup 41
 - timeout for QuickCopy jobs 41
 - toner density 40
 - toner low and out conditions 41

- defects repeating 99
- delaying current jobs 32
- density of toner 40
- Describe Original screen 36
- destination for paper, setting default 39
- Diagnostics menu 42
- different first page, printing 62
- digital-sending
 - advantages 49
 - definition 13
 - description 49
 - ensuring privacy 49
 - file types 49
 - priority 32
 - privacy capability 13
 - setting options 50
 - using address books 53
 - using with LDAP 49
 - See also sending
- dimensions
 - product 122
 - supported for paper in trays 114
- DIMMs
 - location 17
 - replacing 145
- disabling duplexing 39
- disk
 - bad mopy 95
 - failure 87
 - file system full 87
 - operation failed 87
 - volume not present 95
 - write protected 87
- display panel. See control panel
- DOC (Declaration of Conformity)
 - Canadian 135
 - U.S. 134
- documentation
 - additional information 10
 - available on Internet for Windows NT 3.51 57
 - HP Jetdirect Print Server Administrator's Guide 10
 - ordering 127
 - Start guide 10
 - using online guide 7
 - Windows 3.1x 57
- documents
 - sending 50
 - sending two-sided 52
 - setting characteristics 36
 - types to digitally send with scanner glass 50
- dots on page 97
- dots per inch resolution 40
- double-side seam envelopes 120
- downloading HP Web Jetadmin 139
- dpi resolution 40
- drivers, printer. See printer drivers
- dropouts
 - in printing 118
 - on page 98
- duplex printing accessory
 - bad connection message 86
 - clearing jams 81
 - enabling or disabling 39
 - illustration 17, 29
 - installing 56
 - paper orientation 30
 - supported paper sizes 56
 - using 29
 - using with rear output bin 29
- duplexer. See duplex printing accessory



- duplexing
 - binding options 31
 - booklets 61
 - copy jobs 47
 - description 56
 - enabling or disabling 29
 - guidelines 29
 - options for copying 47
 - setting 36
 - setting defaults 39
 - supported media sizes 29
- dust cover
 - location 17
 - Tray 2 and duplexer 56
- duty cycle 14
- Dynamic Host Configuration Protocol 139

E

- EconoMode 40
- economy printing 40
- EIO
 - messages 87
 - slots 17
- EIO 1 JetDirect Menu 41
- electrical specifications 123
- e-mail
 - configuring settings 143
 - multiple addresses 49
 - server address lists 53
 - setting defaults 39
 - setting gateway addresses 39
 - setting scan file type 39
 - testing settings 143
- E-mail page in embedded Web server 143
- embedded Web server
 - browsers to use 138
 - canceling copy and print jobs 138
 - configuring alerts 76
 - description 18, 138
 - diagnosing and troubleshooting problems 138
 - firewall limitations 138
 - installing 138
 - managing job functions 138
 - obtaining product information 138
 - opening 139
 - reaching 139
 - requirements 138
 - using 138
 - using with HP Web Jetadmin 144
- EMI statement for Korea 135
- emissions, acoustic 124
- enabling duplexing 39
- energy consumption 123, 132
- EnergyStar 132
- enlarge button on control panel 34
- enlarging
 - button on control panel 34
 - copies 48
 - copy size 34
 - page view 8
- envelope feeder
 - illustration 17
 - setting size from control panel 64
 - specifications 26
 - supported paper sizes and weights 116
 - using 26

- envelopes
 - adhesive strips or flaps 120
 - curled 120
 - double-side seam 120
 - feeding from envelope feeder 26
 - guidelines 26
 - handling flaps 120
 - margins 26, 120
 - printing 26
 - printing to rear output bin 22
 - solving repeated jams 85
 - specifications 26, 120
 - storing 120
 - supported sizes and weights 114
 - troubleshooting jams 120
 - wrinkled 26
- environmental product stewardship 132
- environmental specifications 123
- equipment
 - defects 109
 - messages 95
 - packing 109
 - returning 109
 - warranty 109, 133
- error log. *See* event log
- error messages. *See* messages
- error notification for system administrator 143
- errors. *See* troubleshooting
- event log
 - clearing 42
 - printing or viewing 42
- extended warranty 133
- extension for Tray 1 56

F

- face-down output bin 22
- face-up output bin 22
- factory settings, restoring 42
- FasRes 40
- Fast InfraRed (FIR)
 - connection cannot be established 104
 - IRDA compliance 104
 - port status indicator does not light 104
 - printing with 67
 - receiver port location 17
 - status indicator turns off 104
 - troubleshooting receiver 104
- FastRes 40
- faxing, comparison with digital-sending 49
- FCC regulations 131
- features of product 14
- feed rollers, replacing 76
- feeding paper
 - manually from Tray 1 64
 - problems 118
- file directory page for mass storage devices 37
- file types 39, 49, 51, 52
- finding words in online guide 9
- Finland laser statement 136
- FIR (Fast InfraRed). *See* Fast InfraRed (FIR)
- firewall limitations for embedded Web server 138
- firmware DIMM. *See* DIMMs
- first mode 63
- first page, printing different 62
- Fit Page 8
- Fit Visible 8
- Fit Width 8
- flaps on envelopes 120
- Flip Pages Up binding option 31
- font installer 57



- font lists 37
- fonts
 - missing on hard disk accessory 96
 - printing as Courier 103
 - printing list of PCL 37
 - printing list of PS 37
 - selecting Courier version 39
 - setting default as Courier 39
 - setting personality default 41
- fraud hotline 108
- front panel. *See* control panel
- full memory 88
- fuse
 - blown for lamp 94
 - blown for motor 94
- fuser
 - cleaning 73
 - clearing jams 83
 - location 17
 - messages 92
 - paper wrapped around 88
 - removing 83
 - replacing 76
 - setting mode or temperature 38
 - speed 14

G

- gateways
 - setting addresses 39
 - testing 39
- glass, scanner. *See* scanner glass
- go to pages in online guide 8
- graphics, vector 147
- gray background
 - printing on paper 98
 - troubleshooting 118
- guidelines
 - card stock 28, 121
 - custom-size paper 28
 - duplexing 29
 - envelopes 26, 120
 - labels 27, 119
 - paper 113, 118
 - transparencies 27, 119
 - using ADF 21
 - using scanner glass 21

H

- hard disk accessory
 - failure 96
 - font problem 96
 - illustration 17
 - messages 96
 - not recognized 96
 - troubleshooting 96
 - write protected 96
- hardware
 - defects 109
 - messages 95
 - packing 109
 - returning 109
 - warranty 109, 133
- heavy paper
 - printing 22, 28
 - specifications 121

- help
 - ? control panel button 34
 - button in printer driver 60
 - fraud hotline 108
 - HP Support Assistant 107
 - language and in-country options 108
 - online 42
 - online services 107
 - printer driver 60
 - product repair assistance 108
 - screens 60
 - worldwide sales and service offices 112
 - worldwide support options 108
- home pages
 - HP Web Jetadmin 144
 - product 139
- host systems 60, 61
- HP authorized resellers 107
- HP fraud hotline 108
- HP Jetdirect print server
 - communicating with 105
 - installing and configuring with HP Web Jetadmin 144
 - troubleshooting 105
- HP Jetdirect Print Server Administrator's Guide* 10
- HP Jetdirect printer options 41
- HP LaserJet paper 128
- HP LaserJet Printing System 57
- HP LaserJet utility 60
- HP Smart Compression technology 49
- HP Software License Terms 111
- HP Support Assistant 107
- HP SupportPacks 107, 133
- HP Web Jetadmin
 - configuring alerts 76
 - downloading and installing 139
 - installing 60
 - installing and configuring printers 144
 - reaching 144
 - setting type and size settings 64
 - using to reach product home page 139
 - using with embedded Web server 144
 - website 60, 139, 144
- HP-GL/2 commands 147
- HP-UX printer software 61
- humidity specifications 124

I

- I/O menu in control panel 41
- I/O slots 17
- image quality
 - problems 97
 - setting default 39
- image type, setting 36
- increasing
 - copy image brightness 34
 - copy size 34
 - page view 8
- index cards 121
- Information menu in control panel 37
- input trays
 - bad connection message 86
 - cannot feed paper 87
 - clearing jams 80
 - empty condition message 89
 - locking 63
 - orienting paper for duplexing 30
 - understanding order used 63
- inserting blank back page 62



installing
 embedded Web server 138
 HP Web Jetadmin 60, 139
 printer drivers 58
 printers connected to network with HP Jetdirect print server 144
 UNIX printer software 61
interface ports 17
interrupting current jobs 32
IP printing, configuring 60
IRDA compliance for Fast InfraRed (FIR) Receiver 104

J

jams
 clearing from ADF (automatic document feeder) 84
 clearing from duplexer 81
 clearing from fuser area 83
 clearing from input tray areas 80
 clearing from output areas 82
 clearing from top cover area 79
 configuring alerts 76
 description 78
 locating 78
 setting default for recovery 41
 solving repeated 85
Japan VCCI statement 135
Jetadmin. *See* HP Web Jetadmin
Jetdirect Print Server Administrator's Guide 10
Jetdirect print server. *See* HP Jetdirect print server
job handling priorities 32
job interrupts, setting defaults 41
Job Storage Disk Error page 86
jobs
 canceling using control panel 34
 canceling using embedded Web server 138
 delaying 32
 handling multiple 32
 handling priorities 32
 infrared 68
 interrupting 32
 managing 65, 138
 retaining 65
 setting limit on number stored 41
 setting timeout 41
JPEG file type 39, 51, 52
jumping to pages in online guide 8

K

kit for printer maintenance
 ordering 127
 using 76
Korea EMI statement 135

L

labels
 orienting sheets 27
 printing 27
 printing to rear output bin 22
 solving repeated jams 85
 specifications 119
 supported sizes and weights 114
lamp
 blown fuse 94
 testing 42
languages
 available for watermarks 62
 not available for printer 88
 options for customer service 108
 printer 147
 setting default 41
 switching printer 59, 147

laser safety statements
 Finland 136
 U.S. 135
LaserJet paper 128
LaserJet Utility. *See* HP LaserJet Utility
LaserWriter printer driver 60
late-breaking product information 56
layout options
 duplexing 31
 printing multiple pages on one sheet 62
LDAP
 configuring 143
 setting gateway address 39
 testing settings 143
 using with digital-sending 49
letterhead paper
 duplexing 30
 printing 25
letter-size paper, setting default 39
license for software 111
light button on control panel 34
light printing 97
lights on control panel
 description 34
 testing 42
Lightweight Directory Access Protocol (LDAP). *See* LDAP
line voltage 123
lines on page 98, 101
Linux printer installer 61
loading
 envelopes in Tray 1 26
 Tray 1 23, 56
 Tray 2, 3, and 4 24
 Trays 2, 3, and 4 56
locating jams 78
locked menus message 86
locking
 carriage 42
 defaults 138
 functions on control panel 60
 trays 63
loose toner 118
low toner, setting default 41

M

Mac OS printer driver 57
Macintosh 62
 HP LaserJet utility 60
 PPDs 58, 60
 printer drivers 60
 printing with infrared 67
 software 60
magnifying
 copies 48
 page view 8
maintenance
 interval 42
 kit 76, 127
 product 76, 137
 repairs 108
maintenance count, resetting 42
managing job functions 65, 138
manual cleaning page 73
manual feed default 39
manually
 cleaning fuser 73
 feeding paper 64
manuals. *See* documentation
map of control panel menus 37



margins
 clipped 103
 custom-size paper 28
 envelopes 26, 120

marks on page 101

material safety data sheet (MSDS) 133

maximum
 paper size 114
 product temperature 118

mechanical problem message 94

media. *See* card stock; custom-size paper; envelopes; HP LaserJet paper; index cards; labels; letterhead paper; paper; preprinted/prepunched paper; special paper; transparencies

memory
 changed settings message 88
 DIMM illustration 17
 full message 88
 insufficient 91
 shortage messages 88
 specifications 124

menu
 map 37
 options 37

Menu button 34

menus in control panel
 Configure Device 39
 description 33
 Diagnostics 42
 EIO 1 JetDirect 41
 I/O 41
 Information 37
 Paper Handling 38
 Pause/Resume 37
 Print Quality 40
 reaching 37
 Resets 42
 Retrieve Job 37
 Service 42
 System Setup 41

menus locked message 86

messages
 clearing persistent 86
 customizing 60
 equipment 95
 for problems correctable by user 86
 hard disk accessory 96
 list, explanation, and recommended action 86
 mopy disk 95
 status 35
 understanding 86

MFP (multifunction printer) 11

Microsoft Windows
 configuring drivers 59
 NT documentation available on Internet 57
 printer drivers 58
 printing with infrared 67

minimum paper size 114

misfeeding in ADF 102

misformed characters 100

model number for product 17

modes
 cassette 63
 first 63

modifying. *See* changing

monthly duty cycle 14

mopy disk messages 95

mopying (collating)
 messages 86
 using 61

motor fuse blown 94

moving around
 in online guide 7
 in the control panel 35

MSDS (material safety data sheet) 133

M-TIFF file type 39, 51, 52

multifunction printer (MFP) 11

multiple copies 44

multi-purpose tray. *See* tray 1

N

naming the product 60

narrow paper, printing 25

navigating
 in online guide 7
 in the control panel 35

NetWare parameters 144

network
 assigning zone 60
 HP Web Jetadmin software for 60
 information using embedded Web server 138
 printing 13
 reducing traffic 61
 software 60

network administrator. *See* system administrator

Networking pages 139

noise emissions 124

notification of errors for system administrator 143

Novell NetWare parameters 144

number of sides, setting default 39

numbers
 model 17
 parts, accessories, and supplies 126
 printing for supply order 37
 product 17
 serial 17, 42

n-up printing 62

O

offices worldwide for customer sales and service 112

one side to two sides, copying 47

one-touch copying 44

online guide
 browsing with thumbnails 9
 finding information 8
 finding words 9
 magnifying page view 8
 navigating 7
 paging through 8
 printing 9
 using 7

online help
 printer driver 60
 product 42

online services
 description 107
 HP Support Assistant 107
 parts information 107
 printer drivers, printer software, product and support information 107
 software utilities 107

opening
 embedded Web server 139
 HP Web Jetadmin 144

operating systems
 supported 58
 website for supported 60, 61

operating temperature 124

optical system problem 94



- options
 - color 51
 - duplexing for copying 47
 - file type 51
 - setting for digital-sending 50
- order of trays used 63
- ordering parts and accessories 125
- orienting
 - for duplexing 30
 - label sheets 27
 - special paper 25
 - transparencies 27
- originals, setting defaults 39
- OS/2 printer drivers 58
- output bins
 - clearing jams 82
 - location 17
 - using 22, 25
- output quality problems 97
- overhead transparencies. *See* transparencies
- overriding printer settings 59
- ozone production 132

P

- packing equipment 109
- page count
 - displaying 42
 - resetting 42
 - setting threshold at which next service becomes due 42
- pages
 - displaying count 42
 - do not print 103, 104
- paging through online guide 7, 8
- paper 39
 - card stock 121
 - custom size 28
 - custom-size 22
 - guidelines for using 118
 - heavy 121
 - manually feeding 64
 - printing custom-size 28
 - problem symptoms, causes, and solutions 118
 - pulled from wrong tray 103
 - recycling 133
 - saving 132
 - setting defaults 39
 - small or narrow 25
 - specifications 113
 - types supported 117
 - types to avoid 118
 - weights and sizes supported for envelope feeder 116
 - weights and sizes supported for Tray 1 114
- paper destination, setting default 39
- Paper Handling menu in control panel 38
- paper jams. *See* jams
- paper path
 - cleaning 73
 - testing 42
- paper size, setting default 39
- paper tray extension 56
- paper trays
 - adjusting 63
 - bad connection message 86
 - cannot feed paper 87
 - clearing jams 78, 80
 - empty condition message 89
 - loading 56
 - loading Tray 1 56
 - locking 63
 - orienting paper for duplexing 30
- parallel interface port 17
- part numbers
 - list and description 126
 - printing for supply reorder 37
- partial page prints 97, 104
- parts
 - after production has stopped 133
 - information on CD 107
 - numbers 126
 - returning 109
 - shipping and packing 109
 - website for identification and pricing 107
- passwords
 - Networking pages in embedded Web server 139
 - product 60
 - protection 138
- Pause/Resume menu 37
- PCL (Printer Command Language)
 - commands 147
 - font list 37
 - setting default 41
 - setting parameters for printing 39
- PCL 5e and PCL 6 printer drivers
 - included with product 58
 - when to use 59
- PDF (portable document format) documents
 - browsing with thumbnails 9
 - finding information 8
 - finding words 9
 - icons 7
 - increasing and decreasing magnification 8
 - navigating 7
 - printing 9
 - setting format for sending 51
 - using 7
 - viewing 8
- PDF file type 39, 52
- perform printer maintenance message 76
- personality, setting 41
- photographs, setting for 36
- photos. *See* photographs
- physical dimensions for product 122
- pickup rollers, replacing 76
- pictures. *See* photographs
- PJL (Printer Job Language) 147
- plastics, recycling 132
- port status indicator for FIR does not light 104
- portable document format (PDF) documents. *See* PDF (portable document format) documents
- ports
 - accessory interface 17
 - FIR (Fast InfraRed) receiver 17
 - locations 17
 - parallel interface 17
- postcards
 - printing 28
 - specifications 121
- PostScript Level 2 emulation 58
- PostScript Printer Description (PPD) files 60
- PostScript. *See* PS
- pound sign (#) key 34
- power
 - connector location 17
 - consumption 123
 - requirements 123
 - saving 132
 - standby 123
- power envelope feeder. *See* envelope feeder



- PowerSave
 - default activation time 123
 - mode 132
 - power consumption 123
 - timeout 41
 - turning on and off 42
- PPDs (PostScript Printer Description) files 60
- preprinted/prepunched paper
 - duplexing 30
 - printing 25
- preventative maintenance 76
- pricing for parts 107
- print cartridges
 - checking toner level 70
 - clearing jams 79
 - hotline to report fraud 108
 - location 17
 - material safety data sheet (MSDS) 133
 - setting default for toner low and out conditions 41
 - shaking 71
 - supplies information available with genuine HP 70
 - warranty 110
- print drivers. *See* printer drivers
- print jobs. *See* jobs
- Print Quality menu 40
- print quality problems
 - correcting 97
 - symptoms, causes, and solutions 118
- print registration, setting 40
- print servers
 - communicating with HP Jetdirect 105
 - troubleshooting 105
- print speed 124
- print usage page 37
- Printer Collation Error page 86
- Printer Command Language (PCL). *See* PCL (Printer Command Language)
- printer commands
 - HP-GL/2 147
 - PCL 147
 - PJL 147
- printer drivers
 - Apple LaserWriter 60
 - available on Internet for Windows NT 3.51 57
 - choosing the appropriate one 59
 - configuring 59
 - configuring for duplexer 29
 - description 58
 - help software 60
 - included with product 58
 - Macintosh 60
 - Microsoft Windows 59
 - OS/2 58
 - PCL 5e 59
 - PCL 6 59
 - PS 59
 - website 107
- printer event log 138
- Printer Job Language (PJL) 147
- printer maintenance kit
 - ordering 127
 - using 76
- printer software website 107

- printing
 - booklets 61
 - by type and size of paper 63
 - configuration page 37
 - delaying current job 32
 - different first page 62
 - envelopes 26
 - envelopes from Tray 1 120
 - event log 42
 - feeding paper manually 64
 - file directory page for mass storage devices 37
 - for IP 60
 - heavy paper 28, 121
 - in color 49
 - labels 27
 - list of PS fonts 37
 - menu map 37
 - multiple pages on one sheet 62
 - online guide 9
 - over network 13
 - PCL font list 37
 - print usage page 37
 - priority 32
 - setting defaults 39
 - speed 14, 124
 - supplies status page 37
 - transparencies 27
 - watermarks 62
 - wireless 67
- priorities for jobs 32
- privacy through digital-sending 49
- problems. *See* troubleshooting
- protecting the environment 132
- protection with passwords 138
- PS
 - error page 39
 - setting default 41
 - troubleshooting 103
- PS printer drivers
 - included with product 58
 - when to use 59
- punched paper, printing 25

Q

- quality
 - changing copy 48
 - improving 97
 - setting default 39
- Quick Sets 61
- QuickCopy jobs, setting timeouts 41

R

- reaching
 - embedded Web server 139
 - HP Web Jetadmin 144
- Reader for Adobe Acrobat 8, 9
- Readme.txt file 56
- Readme.wri file 56
- Ready light 34
- rear output bin
 - clearing jams 82
 - location 17
 - using 22
 - using with duplexer 29
- recycling
 - paper 133
 - plastics 132
- redistributing toner in the cartridge 71
- reduce button on control panel 34



- reducing
 - button on control panel 34
 - copies 48
 - copy size 34
 - network traffic 61
- registration, setting 40
- regulations
 - Canada DOC 135
 - FCC 131
 - U.S. DOC 134
- regulatory information 131
- relative humidity specifications 124
- remote
 - configuration 18
 - product management and troubleshooting 60, 144
- removing
 - background 39
 - fuser 83
- repacking equipment 109
- repairs 108
- repeating
 - defects 99
 - images 100
- replacing DIMMs 145
- requirements
 - embedded Web server 138
 - environmental 123
 - power 123
 - space 122
- resellers, HP authorized 107
- Reset button 34
- Resets menu 42
- resetting page count 42
- Resolution Enhancement technology (REt) 40
- resolutions 40
- Resource Manager. *See* HP Resource Manager
- REt (Resolution Enhancement technology) 40
- Retrieve Job menu 37
- returning equipment 109
- RIP ONCE 14, 61
- rollers, replacing 76
- rough paper, printing 22
- running the manual cleaning page 73

S

- safety statements
 - laser products 135
 - laser products in Finland 136
- sales and service offices 112
- saving
 - power, paper, and toner 132
 - printer settings 61
- scaling copies
 - automatically 48
 - manually 48
- scaling page images 61
- scanner carriage, locking 42
- scanner glass
 - types of originals accommodated 50
 - using 21
- scanning
 - configuring defaults using embedded Web server 143
 - priority 32
 - setting defaults for e-mail 39
 - while printing is underway 32
- security levels 138
- Send Options screen 36
 - illustration 50
 - using 50

- sending
 - available file formats 52
 - setting defaults 39
 - setting timeout 41
 - two-sided documents 52
 - See also* digital-sending
- serial number
 - finding on Service menu 42
 - product 17
- service
 - agreements 107
 - HP SupportPacks 107
 - parts information on CD 107
 - worldwide offices 112
 - See also* customer support
- Service Information form 109
- Service menu 42
- setting
 - color 51
 - custom paper sizes 28
 - device defaults 39
 - document characteristics 36
 - document size 36
 - file type 51
 - HP Jetdirect printer options 41
 - image type 36
 - menu options 37
 - page count 42
 - personality default 41
 - print registration 40
 - resolution 40
 - single- or double-sided printing 36
 - toner density 40
 - Tray 1 option 63
- setting up the product 10, 137
- settings
 - copy contrast 48
 - copy defaults 44
 - copying 39, 46
 - document characteristics 36
 - e-mail 39
 - originals 39
 - printer driver 59
 - product 60
 - restoring factory 42
 - saving printer 61
 - scanner defaults 143
 - sending 39
 - toner density 40
 - user-defined for copying 45
- Settings field for selecting document parameters 51
- shaking print cartridges 71
- sharing in workgroup 13
- single copies 44
- size
 - keeping small using HP Smart Compression technology 49
 - reducing copy 34
 - setting for documents 36
- sizes
 - printing by 63
 - scaling pages 61
 - supported for paper in envelope feeder 116
 - supported for paper in Tray 1 114
- skewed page 100
- slides. *See* transparencies
- small paper
 - printing 22, 25
 - setting default 40
- Smart Compression technology 49
- smearing on paper 99
- SMTP address 39, 143



- software
 - help for printer drivers 60
 - license 111
 - Macintosh 60
 - network 60
 - Sun Solaris 61
 - UNIX 61
 - utilities 107
 - Windows 59
- Solaris printer software 61
- space requirements 122
- spare parts after production has stopped 133
- special paper
 - manually feeding 64
 - printing 25
- specifications
 - acoustic emissions 124
 - card stock 121
 - electrical 123
 - envelope feeder 120
 - envelopes 120
 - environmental 123
 - general 124
 - heavy paper 121
 - humidity 124
 - labels 119
 - memory 124
 - paper 113
 - product 122
 - transparencies 119
- specks on page 97
- speed
 - ADF (automatic document feeder) 14
 - fuser 14
 - printing 14
 - product 14
- spots on page 101
- standby power consumption 123
- Start button 34
- Start guide 10
- status bar on control panel 35
- stewardship program 132
- Stop button 34
- storing
 - envelopes 120
 - print jobs 66
 - setting limits 41
- straight-through paper path 22
- Sun Solaris printer software 61
- supplies
 - after production has stopped 133
 - consumable levels 138
 - part numbers 126
- supplies status page 37
- Support Assistant 107
- support contact URLs, configuring 139
- support. *See* customer support
- SupportPacks 107, 133
- switching printer languages 59
- symptoms of output quality problems 97
- system administrator
 - contact information 143
 - error notification 143
 - guide 137
- System Setup menu 41

T

- TCP/ IP requirements for embedded Web server 138
- technical support. *See* customer support

- temperature
 - maximum product 118
 - operating 124
 - setting for fuser 38
- Test button
 - e-mail settings 143
 - LDAP address settings 143
- testing
 - control panel hardware 42
 - LDAP settings 143
 - lights on control panel 42
 - paper path 42
 - scanner and ADF hardware 42
- testing gateway connections 39
- thickness of paper supported 114
- throughput of product 14
- thumbnails, using to browse in online guide 9
- tif file type 39
- TIFF file type 39, 51, 52
- timeouts
 - clearable warnings 41
 - copying and sending 41
 - input/output 41
 - PowerSave mode 41
 - QuickCopy jobs 41
- tire tracks on page 101
- toner
 - checking level 70
 - cleaning from clothing 72, 79
 - cleaning with cleaning page 40
 - configuring low and out alerts 76
 - non-HP detected 88
 - redistributing in cartridge 71
 - remaining in printer after jam 78
 - saving 132
 - setting default for toner low and out conditions 41
 - setting density 40
 - smear problem 99
 - troubleshooting 118
- toner cartridges. *See* print cartridges
- top cover, clearing jams under 79
- top output bin
 - clearing jams 82
 - location 17
- tracks on page 101
- transfer rollers, replacing 76
- transparencies
 - printing 22, 27
 - solving repeated jams 85
 - specifications 119
 - supported sizes and weights 114
- Tray 1
 - capacity 114
 - cassette vs. first mode 63
 - clearing jams 80
 - customizing operation 63
 - description 56
 - envelope specifications 120
 - load message 89
 - loading 23, 56
 - loading envelopes 26
 - orienting paper for duplexing 30
 - orienting special paper 25
 - printing envelopes 26
 - setting media type 38
 - setting mode of operation 38
 - setting size from control panel 64
 - setting size of paper 38
 - supported paper sizes and weights 114



Tray 2
 adjusting for paper 56
 bad connection message 86
 clearing jams 80
 description 56
 load message 89
 loading 24, 56
 orienting paper for duplexing 30
 orienting special paper 25
 setting size from control panel 64
 setting size of paper 38

Tray 3
 adjusting for paper 56
 bad connection message 86
 clearing jams 80
 description 56
 load message 89
 loading 24, 56
 orienting paper for duplexing 30
 orienting special paper 25
 setting size from control panel 64
 setting size of paper 38

Tray 4
 adjusting for paper 56
 bad connection message 86
 clearing jams 80
 description 56
 load message 89
 loading 24, 56
 orienting paper for duplexing 30
 orienting special paper 25
 setting size from control panel 64
 setting size of paper 38

trays
 clearing jams 80
 configuration information 138
 order of use 63
 paper pulled from wrong 103
 setting mode of operation 38

troubleshooting
 control panel messages 86
 hard disk accessory 96
 HP Fast InfraRed Receiver 104
 HP Jetdirect print server 105
 jams 78
 output quality problems 97
 print quality problems 118
 PS issues 103
 remotely using embedded Web server 144
 summary of techniques 77
 using event log 42

two sides to one side, copying 47
 two sides to two sides, copying 47
 two-sided documents. *See* duplexing
 two-up printing 62
 type settings, printing by 63

U

unauthorized access, preventing 60
 understanding tray order 63
 UNIX printer installer 61
 usage page 37

Use guide

browsing with thumbnails 9
 finding information 8
 finding words 9
 magnifying page view 8
 navigating 7
 paging through 8
 printing 9
 using 7
 user-defined settings for copying 45
 utilities for software 107

V

VCCI statement for Japan 135
 vector graphics 147
 vertical white lines 101
 viewing
 event log 42
 online guide 8
 PDF (portable document format) files 8

W

walk-up copying. *See* copying
 warnings, setting default 41
 warranty
 extended 133
 hardware maintenance 133
 print cartridge 110
 printer 109
 watermarks
 languages available for Macintosh 62
 orienting paper for duplexing 30
 printing 62
 wavy paper 100
 Web Jetadmin. *See* HP Web Jetadmin
 Web server. *See* embedded Web server
 websites
 Adobe Acrobat Reader 9
 HP Support Packs 107
 HP Web Jetadmin 60, 139, 144
 material safety data sheet (MSDS) 133
 parts identification and pricing 107
 printer software 107
 supported host systems 60, 61
 weight
 ADF 123
 paper 114
 product 123
 scanner 123
 supported for paper in envelope feeder 116
 white lines 101
 white spots on black 101
 Windows. *See* Microsoft Windows
 wireless printing 67
 workgroup sharing 13
 worldwide
 sales and service offices 112
 support options 108
 wrinkled paper 101
 write-protected
 disk 87
 hard disk accessory 96

Z

zone, assigning on the network 60
 zooming in and out of pages 8
 ZoomSmart 61





© 2001-2004 Hewlett-Packard Development Company, LP

<http://www.hp.com/support/lj4100mfp>