

HP Color LaserJet 2600n

User Guide

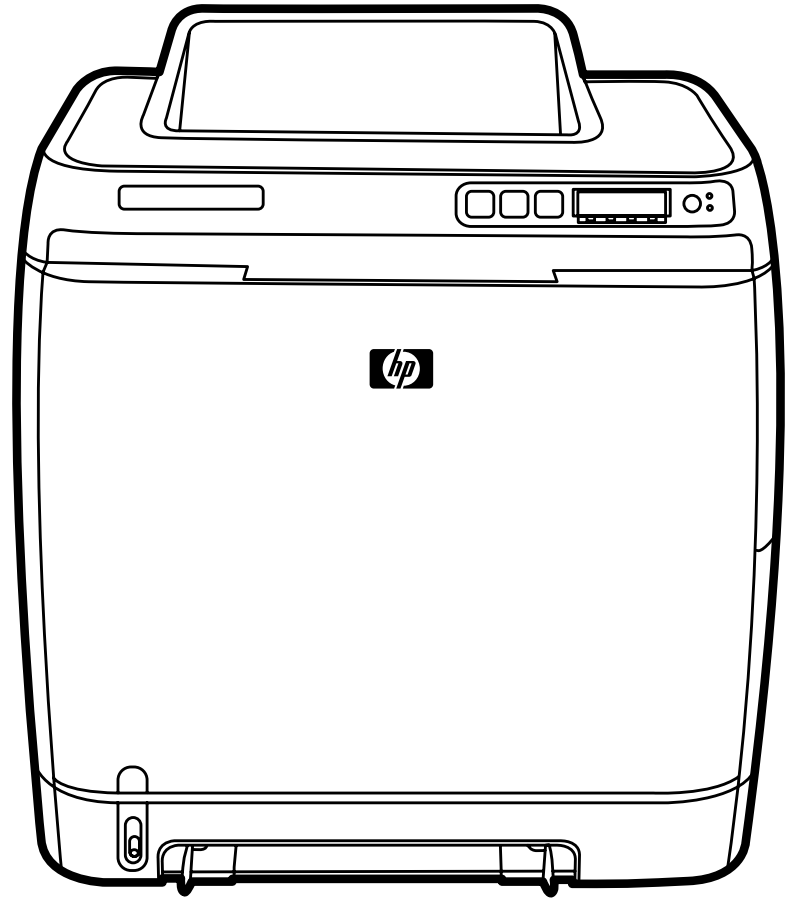

HP Color LaserJet 2600n Printer

User Guide _____

Copyright and License

© 2005 Copyright Hewlett-Packard Development Company, L.P.

Reproduction, adaptation, or translation without prior written permission is prohibited, except as allowed under the copyright laws.

The information contained in this document is subject to change without notice.

The only warranties for HP products and services are set forth in the express warranty statements accompanying such products and services. Nothing herein should be construed as constituting an additional warranty. HP shall not be liable for technical or editorial errors or omissions contained herein.

Part number Q6455-90937

Edition 1, 4/2005

Trademark Credits

Adobe Photoshop® and PostScript are trademarks of Adobe Systems Incorporated.

CorelDRAW™ is a trademark or registered trademark of Corel Corporation or Corel Corporation Limited.

Microsoft®, Windows®, MS-DOS®, and Windows NT® are U.S. registered trademarks of Microsoft Corporation.

Netscape™ and Netscape Navigator™ are U.S. trademarks of Netscape Communications Corporation.

TrueType™ is a U.S. trademark of Apple Computer, Inc.

ENERGY STAR® and the ENERGY STAR logo® are U.S. registered marks of the United States Environmental Protection Agency. Details on the proper use of the marks are explained in the "Guidelines for Proper use of the ENERGY STAR® Name and International Logo."



HP Customer Care

Online services

for 24-hour access to information by using a modem or Internet connection

World Wide Web: Updated HP printer software, product and support information, and printer drivers in several languages can be obtained from <http://www.hp.com/support/clj2600n>. (The site is in English.)

Online troubleshooting tools

HP Instant Support Professional Edition (ISPE) is a suite of Web-based troubleshooting tools for desktop computing and printing products. ISPE helps you quickly identify, diagnose, and resolve computing and printing problems. The ISPE tools can be accessed from <http://instantsupport.hp.com>.

Telephone support

Hewlett-Packard provides free telephone support during the warranty period. When you call, you will be connected to a responsive team that is waiting to help you. For the telephone number for your country/region, see the flyer that came in the box with the product, or visit <http://welcome.hp.com/country/us/en/wwcontact.html>. Before calling HP, have the following information ready: product name and serial number, date of purchase, and description of the problem.

You can also find support on the Internet at <http://www.hp.com>. Click the **support & drivers** block.

Software utilities, drivers, and electronic information

Go to http://www.hp.com/go/clj2600n_software. (The site is in English, but printer drivers can be downloaded in several languages.)

For information over the telephone, see the flyer that came in the box with the printer.

HP direct ordering for accessories or supplies

Order supplies from the following websites:

North America: <https://www.hp.com/post-embed/ordersupplies-na>

Latin America: <https://www.hp.com/post-embed/ordersupplies-la>

Europe and Middle East: <https://www.hp.com/post-embed/ordersupplies-emea>

Asia Pacific countries/regions: <https://www.hp.com/post-embed/ordersupplies-ap>

Order accessories from <http://www.hp.com/accessories>. For more information, see [Accessories and ordering information](#).

To order supplies or accessories over the telephone, call the following numbers:

United States: 1-800-538-8787

Canada: 1-800-387-3154

To find the phone numbers for other countries/regions, see the flyer that came in the box with the printer.

HP service information

To locate HP-Authorized Dealers in the United States or Canada, call 1-800-243-9816 (United States) or 1-800-387-3867 (Canada). Or, go to <http://www.hp.com/go/cposupportguide>.

For service for your HP product in other countries/regions, call the HP Customer Support number for your country/region. See the flyer that came in the box with the printer.

HP service agreements

Call: 1-800-HPINVENT [1-800-474-6836 (U.S.)] or 1-800-268-1221 (Canada).

Out-of-Warranty Service: 1-800-633-3600.

Extended Service: Call 1-800-HPINVENT 1-800-474-6836 (U.S.) or 1-800-268-1221 (Canada). Or, go to the HP Supportpack and Carepaq™ Services website at <http://www.hpexpress-services.com/10467a>.

HP Toolbox

To check the printer status and settings and to view troubleshooting information and online documentation, use the HP Toolbox software. You can view the HP Toolbox when the printer is directly connected to your computer or when it is connected to a network. You must have performed a complete software installation to use the HP Toolbox. See [Managing the printer](#).

Table of contents

1 Printer basics

Quick access to printer information	2
User guide links	2
Where to look for more information	2
Printer configurations	4
HP Color LaserJet 2600n printer	4
Printer features	5
Walk around	7
Software	9
Software and supported operating systems	9
Software tips	9
Software for Windows	10
Software for Macintosh	11
Uninstalling the printing software	11
Print-media specifications	13
General guidelines	13
Paper and print media	13
Printing and storage environment	14
Envelopes	14
Labels	16
Transparencies	16
Supported media weights and sizes	17

2 Control panel

Control panel features	19
Display	20
Understanding Supplies Status	20
Understanding Printer Status	20

3 Networking

To configure a network port-connected device configuration (direct mode or peer-to-peer printing)	24
Supported network protocols	25
TCP/IP configuration	27
Server-based, AutoIP, and manual TCP/IP configuration	27
Server-based TCP/IP configuration	27
Default IP address configuration	27
TCP/IP configuration tools	28
Using BOOTP/TFTP	29
Why Use BOOTP?	29
BOOTP on UNIX	29
Using DHCP	32
UNIX Systems	32
Windows Systems	32

NetWare systems	35
To discontinue DHCP configuration	36
Using the printer control panel	37
Using the embedded Web server	38

4 Printing tasks

Loading trays	40
Loading Tray 1	40
Loading Tray 2 or optional Tray 3	41
Printing on special media	44
Printing on envelopes	44
Printing on labels	46
Transparencies	47
Printing on HP LaserJet glossy paper and HP LaserJet photo paper	48
Printing on letterhead or preprinted forms	50
Printing on HP LaserJet Tough paper	50
Printing on custom-sized print media or cardstock	51
Controlling print jobs	52
Printing by tray Source versus by paper Type or paper Size	52
Gaining access to printer driver settings	56
Printing on both sides	58
To print on both sides (manually)	58
Canceling a print job	60

5 Color

Using color	62
HP ImageREt 2400	62
Media selection	62
Color options	62
Standard red-green-blue (sRGB)	63
Managing color options	64
Print in Grayscale	64
Automatic versus Manual color adjustment	64
Manual color options	64
Matching colors	66

6 How do I?

Print: How do I?	68
Print on special media, such as glossy or photo paper	69
Print on both sides of the paper	70
Print on envelopes and custom media sizes	70
Change the device print settings, such as print quality, in HP Toolbox	71
Print color documents from my computer in black and white only	71
Change color options	71
Network: How do I?	73
Set up the device and use it on the network	73
Set my network password	73
Find my network IP address	73
Configure a static IP address for my printer	74
Other: How do I?	75
Changing print cartridges	75

7 Managing the printer

Special pages	80
Demo page	80
Configuration page	80
Supplies Status page	81
Menu map	83
To print a menu map	83
HP Toolbox	84
Supported operating systems	84
Supported browsers	84
To view the HP Toolbox	85
Status tab	85
Troubleshooting tab	85
Alerts tab	85
Documentation tab	86
Device Settings	86
Other links	86
Using the embedded Web server	87
To access the embedded Web server using a network connection	87
Information tab	88
Settings tab	88
Networking tab	88
Other links found in HP Toolbox	89

8 Maintenance

Managing supplies	92
Supplies life	92
Checking and ordering supplies	92
Storing supplies	93
Replacing and recycling supplies	93
HP policy on non-HP supplies	93
HP anti-counterfeit website	93
Cartridge out override	94
Configuration	94
On-going operation	94
Cleaning the printer	95
To clean the fuser using HP Toolbox	95
Calibrating the printer	96
To calibrate the printer at the printer	96
To calibrate the printer from the HP Toolbox	96

9 Problem solving

Support strategy	98
Troubleshooting process	99
Troubleshooting checklist	99
Control panel messages	101
Alert and warning messages	101
Critical error messages	102
Clearing jams	105
Where to look for jams	105
To clear jams from inside the printer	106
To clear jams from Tray 2 or optional Tray 3	107
To clear jams from the top bin	108
Print problems	109

Print quality problems	109
Media-handling problems	116
Performance problems	118
Troubleshooting tools	120
Device pages and reports	120
HP Toolbox	120
Service menu	121

Appendix A Accessories and ordering information

Supplies	124
Cable and interface accessories	125
Paper handling accessories	126
Paper and other print media	127
User-replaceable parts	129
Supplementary Documentation	130

Appendix B Service and support

Hewlett-Packard limited warranty statement	131
Print Cartridge Limited Warranty Statement	133
Availability of support and service	134
HP Care Pack™ Services and Service Agreements	134
Repacking the printer	135
To repack the printer	135
Service information form	136

Appendix C Specifications

Printer specifications	137
------------------------------	-----

Appendix D Regulatory information

Introduction	139
FCC regulations	140
Environmental Product Stewardship program	141
Protecting the environment	141
Ozone production	141
Energy consumption	141
HP LaserJet printing supplies	141
Material safety data sheet	143
Declaration of conformity	144
Country/region-specific safety statements	145
Laser safety statement	145
Canadian DOC statement	145
Korean EMI statement	145
VCCI statement (Japan)	145
Finnish laser statement	146

Index

1

Printer basics

This section provides information about the following topics:

- [Quick access to printer information](#)
- [Printer configurations](#)
- [Printer features](#)
- [Walk around](#)
- [Software](#)
- [Print-media specifications](#)

Quick access to printer information

User guide links

- [Walk around](#)
- [Control panel features](#)
- [Problem solving](#)

Where to look for more information

Several references are available for use with this printer. See <http://www.hp.com/support/clj2600n>.

Setting up the printer

Getting started guide—Provides step-by-step instructions for installing and setting up the printer.

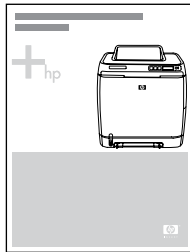

Accessory installation guides—These guides provide step-by-step instructions for installing the printer accessories and are provided with any accessories that are purchased.

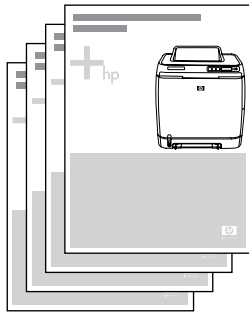

Using the printer

User guide—Contains detailed information for using the printer and troubleshooting problems. This guide is available in two formats on the CD-ROM that came with the printer: in PDF format for printing and HTML format for online viewing. It is also available through the HP Toolbox software.



Online Help—Contains information about printer options that are available within the printer drivers. To view a Help file, open the online Help through the printer driver.

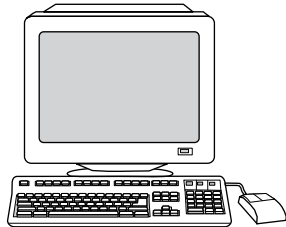

HTML (online) user guide—Contains detailed information for using the printer and troubleshooting problems. Go to <http://www.hp.com/support/clj2600n>. After connecting, select **Manuals**.



Printer configurations

Thank you for purchasing the HP Color LaserJet 2600n printer. This printer is available in the configuration described below.

HP Color LaserJet 2600n printer

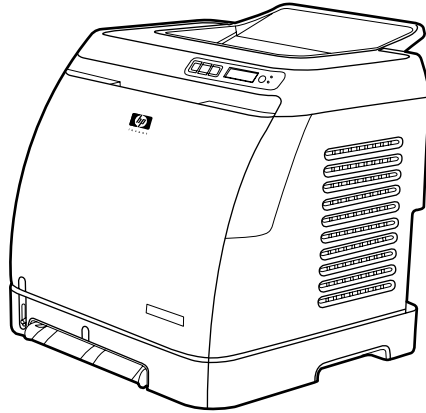

The HP Color LaserJet 2600n printer is a four-color laser printer that prints eight pages per minute (ppm) in both monochrome (black and white) and color.

- **Trays.** The printer comes with a single sheet priority feed slot (Tray 1) and a universal tray (Tray 2) that holds up to 250 sheets of various paper types and sizes or 10 envelopes. It supports an optional 250-sheet paper tray (optional Tray 3). See [Supported media weights and sizes](#) for more information.
- **Connectivity.** The printer provides a Hi-Speed USB 2.0 port for connectivity and an HP built-in internal print server for connecting to a 10/100Base-T network.
- **Memory.** The printer contains 16 megabytes (MB) of synchronous dynamic random access memory (SDRAM). No additional memory can be added.

Printer features

Feature	HP Color LaserJet 2600n printer
Color printing	<ul style="list-style-type: none"> Provides laser printing in full color by using the four process colors: cyan, magenta, yellow, and black (CMYK).
Fast print speed	<ul style="list-style-type: none"> Prints in black on letter-size paper up to 8 ppm and on A4-size paper up to 8 ppm. Prints in color on A4/letter at 8 ppm.
Excellent print quality	<ul style="list-style-type: none"> ImageREt 2400 provides 2400 dpi equivalent-color quality through a multilevel printing process. True 600 by 600 dots per inch (dpi) text and graphics. Adjustable settings to optimize print quality. The HP UltraPrecise print cartridge has a finer toner formulation that provides sharper text and graphics.
Ease of use	<ul style="list-style-type: none"> Few supplies to order. Supplies are easy to install. Convenient access to printer information and settings by using the HP Toolbox software. Convenient access to all supplies and to the paper path through the front door.
Flexible paper handling	<ul style="list-style-type: none"> Trays 1 and 2 for letterhead, envelopes, labels, transparencies, custom-sized media, postcards, HP LaserJet glossy paper, HP LaserJet Tough paper, heavy paper, and HP Laser Photo paper. A 125-sheet top output bin. Print on Both Sides (manually). See Printing on both sides.
Interface connections	<ul style="list-style-type: none"> Hi-Speed USB port. The HP Color LaserJet 2600n printer includes an HP built-in internal print server for connecting to a 10/100Base-T network.
Energy savings	<ul style="list-style-type: none"> The printer automatically conserves electricity by substantially reducing power consumption when it is not printing. As an ENERGY STAR® partner, Hewlett-Packard Company has determined that this product meets ENERGY STAR® guidelines for energy efficiency. ENERGY STAR® is a U.S. registered service mark of the United States Environmental Protection Agency.

Feature	HP Color LaserJet 2600n printer
Economical printing	<ul style="list-style-type: none"> ● N-up printing (printing more than one page on a sheet) and Printing on Both Sides features save paper. See Printing multiple pages on one sheet of paper (N-up printing) and Printing on both sides.
Supplies	<ul style="list-style-type: none"> ● A Supplies Status page with print cartridge gauges that show the supply levels that remain. For HP supplies only. ● No-shake cartridge design. ● Authentication for HP print cartridges. ● Enabled supplies-ordering capability.
Accessibility	<ul style="list-style-type: none"> ● Online user guide that is compatible with text screen-readers. ● All doors and covers can be opened by using one hand.
Expandability	<ul style="list-style-type: none"> ● Optional Tray 3. This 250-sheet universal tray reduces how often you have to add paper to the printer. Only one additional 250-sheet tray can be installed on the printer. ● Optional HP Jetdirect external print server for connecting to a network.

Walk around

The following illustrations identify the locations and names of key components of this printer.

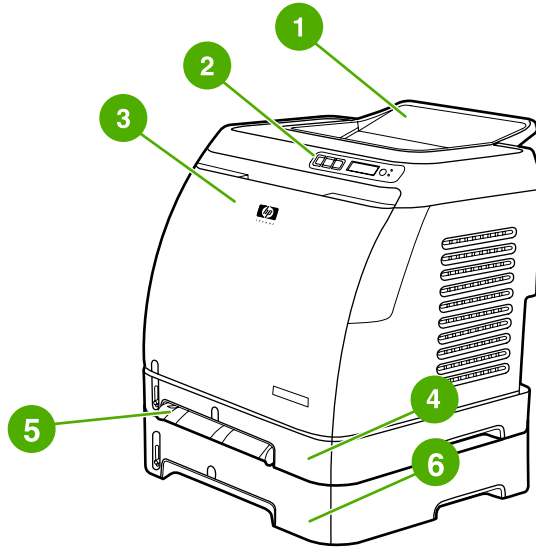

Front view (shown with optional Tray 3)

- 1 Output bin
- 2 Printer control panel
- 3 Front door
- 4 Tray 2 (250 sheets)
- 5 Tray 1 (single sheet priority feed slot)
- 6 Tray 3 (optional; 250 sheets)

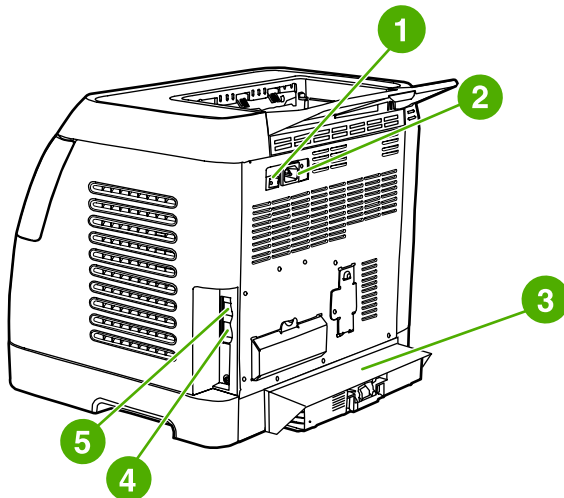

Back and side view

- 1 On/off switch
- 2 Power connection
- 3 Dust cover
- 4 HP built-in internal print server for connecting to a 10/100Base-T network
- 5 USB connection

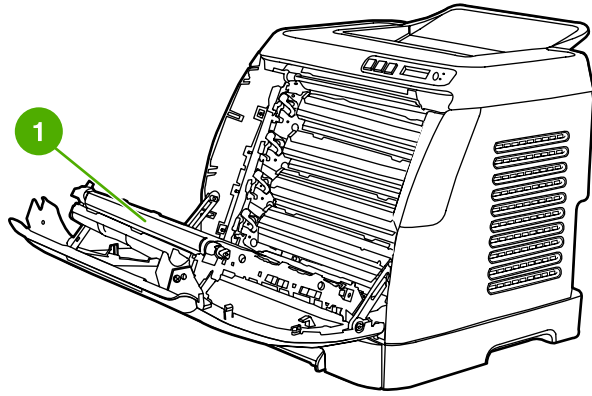

1 Transfer belt (ETB)

CAUTION

Do not place anything on the transfer belt , which is located on the inside of the front door. Otherwise, the printer may be damaged, adversely affecting print quality.

Software and supported operating systems

For easy printer setup and access to the full range of printer features, HP strongly recommends that you install the software that is provided. Not all software is available in all languages. See the *Getting Started Guide* for installation instructions, and see the Readme file for the latest software information.

The most recent drivers, additional drivers, and other software are available from the Internet and other sources. If you do not have access to the Internet, see [HP Customer Care](#).

The printer supports the following operating systems:

- Microsoft® Windows® 98 Second Edition and Windows Millennium Edition (Me) (Add Printer installation)
- Microsoft® Windows® 2000 and Windows XP
- Microsoft® Windows® Server 2003
- Macintosh OS X v10.2 and later

The following tables list the software that is available for your operating system.

HP Color LaserJet 2600n printer software

Feature	Windows 98 Second Edition, Me	Windows 2000 and XP	Macintosh OS X v10.2 and later
Windows Installer		✓	
Windows printer driver	✓	✓	
HP Toolbox software	✓	✓	
Macintosh Installer			✓
Macintosh printer drivers			✓

Software tips

The following are some tips for working with the printer software.

How do I gain access to the printer features?

The printer features are available in the printer driver. Some features such as custom paper sizes and page orientation might also be available in the program you are using to create a file. Change settings in the program, if possible, because changes that are made in the program override changes that are made in the printer driver.

Gain access to advanced printer features through the printer driver (or the **Print** dialog box for Macintosh operating systems). See [Gaining access to printer driver settings](#) for help with specific printer-driver features.

How do I get the latest printing software?

When you want to check for and install upgrades to the printing software, you can download drivers from the World Wide Web or HP's file transfer protocol (FTP) servers.

To download drivers

1. Go to <http://www.hp.com/support/clj2600n>. Click the **support & drivers** block.
2. The Web page for the drivers might be in English, but you can download the drivers themselves in several languages.

If you do not have Internet access, contact HP Customer Care. (See [HP Customer Care](#) or the flyer that came in the printer box.) See the Readme file for additional release information.

What other software is available?

See the Readme file that is provided on the HP Color LaserJet 2600n CD-ROM for additional, included software and for supported languages.

Software for Windows

When you install the software for Windows, you can directly connect the printer to a computer by using a USB cable or you can connect the printer to the network by using HP built-in networking. See the *Getting Started Guide* for installation instructions, and see the Readme file for the latest software information.

The following software is available to all users of the printer, whether you connected the printer directly to a computer by using a USB cable, or to the network through the HP built-in networking internal print server.

Printer drivers

A printer driver is a software component that provides access to printer features and provides the means for the computer to communicate with the printer. For help using your printer driver, see [Gaining access to printer driver settings](#).

Using Help

The printer driver has **Help** dialog boxes that can be activated from the **Help** button in the printer driver, the **F1** key on the computer keyboard, or the question mark symbol (?) in the upper-right corner of the printer driver. These **Help** dialog boxes give detailed information about the specific printer driver. Help for the printer driver is separate from the Help for your program.

HP Toolbox

You must perform a complete software installation to use the HP Toolbox.

The HP Toolbox provides links to printer status information and help information, such as this user guide; and tools for diagnosing and solving problems. You can also view explanations and animations on the control panel. See [Maintenance](#) for more information.

Software for Macintosh

The printer includes the following software for Macintosh computers.

Macintosh printer driver

When you install the software for Macintosh, you can directly connect the printer to a computer by using a USB cable or you can connect the printer to the network by using HP built-in networking. For help using your printer driver, see [Gaining access to printer driver settings](#). If you are connected via the network, you can configure your printer using the embedded Web server.

Uninstalling the printing software

Uninstall software by using the following directions for your operating system.

Uninstalling software for Windows

The printer comes with an uninstall utility that you can use to select and remove any or all of the Windows HP printing system components from your computer.

To uninstall software for Windows 98 Second Edition and later

NOTE

To uninstall the software from Windows 2000 or XP, you must log on with administrator privileges.

1. Close all of the open programs.

For Windows 98 Second Edition and Me

- a. Press **Ctrl+Alt+Delete**. The **Close Program** dialog box opens.
- b. Select a program *except* Explorer or Systray, and click **End Task**.
- c. Repeat step b until all of the programs except Explorer and Systray are closed.

For Windows 2000 and XP

- a. Press **Ctrl+Alt+Delete**. The **Windows Security** dialog box opens.
 - b. Click **Task Manager** and then click the **Applications** tab.
 - c. Select a program, and then click **End Task**.
 - d. Repeat step c until all of the programs are closed.
2. On the **Start** menu, point to **Programs**, point to **HP**, point to **HP Color LaserJet 2600n**, and click **Uninstall HP Color LaserJet 2600n**.
 3. On the Setup screen, click **Next**.
 4. Click **Next**, and follow the directions on the screen. If the message **The following file is a shared file but is not used by any other programs. Would you like to delete it?** appears, click **Yes to All**. The system finishes removing files.
 5. If prompted to restart the computer, click **OK**.

Uninstalling software for Windows by using Add or Remove Programs

An alternate method for uninstalling the printer software is to use the **Add or Remove Programs** method. This method does *not* require you to have the software CD.

1. Click **Start**, point to **Settings**, and click **Control Panel**.
2. Click **Add or Remove Programs**.
3. Scroll through the list of software programs and click **HP Color LaserJet 2600n** printer.
4. Click **Remove**.

Uninstalling software for Macintosh

To remove the printer from your Macintosh use the following steps:

1. Open Print Center (v10.2) or Print Setup Utility (v10.3).
2. Select the printer name.
3. Select **Delete**.

Print-media specifications

This section contains information about specifications for the quality of print media, guidelines for print media usage, and guidelines for print media storage.

General guidelines

Some print media might meet all of the guidelines in this manual and still not produce satisfactory results. This problem might be the result of improper handling, unacceptable temperature and humidity levels, or other variables over which Hewlett-Packard has no control.

Before purchasing large quantities of print media, always test a sample and make sure that the print media meets the requirements specified in this user guide and in the *HP LaserJet Printer Family Print Media Guide*. For ordering information, see [Accessories and ordering information](#).

CAUTION

Using print media that does not meet HP specifications can cause problems for the printer, requiring repair. This repair is not covered by the Hewlett-Packard warranty or service agreements.

CAUTION

Use only paper designed for laser printers. Paper for inkjet printers may damage the printer.

This printer accepts a variety of media, such as cut-sheet paper (including up to 100% recycled-fiber-content paper), envelopes, labels, transparencies, HP LaserJet glossy paper, HP LaserJet Tough paper, HP LaserJet Photo paper, and custom-size paper. Properties such as weight, composition, grain, and moisture content are important factors that affect printer performance and output quality. Print media that does not meet the guidelines outlined in this manual can cause the following problems:

- Poor print quality
- Increased jams
- Premature wear on the printer, requiring repair

Paper and print media

Category	Specifications
Acid content	5.5 pH to 8.0 pH
Caliper	0.094 to 0.18 mm (3.0 to 7.0 mils)
Curl in ream	Flat within 5 mm (0.02 in.)
Cut-edge conditions	Cut with sharp blades with no visible fray
Fusing compatibility	Must not scorch, melt, offset, or release hazardous emissions when heated to 210°C (410°F) for 0.1 second
Grain	Long Grain
Moisture content	4% to 6% by weight

Category	Specifications
Smoothness	100 to 250 Sheffield

For complete print-media specifications for all HP LaserJet printers, see the *HP LaserJet Printer Family Print Media Guide*. To download the guide in PDF format, go to <http://www.hp.com/support/ljpaperguide>.

Printing and storage environment

Ideally, the printing and media-storage environment should be at or near room temperature, and not too dry or too humid. Remember that paper is hygroscopic; it absorbs and loses moisture rapidly.

Heat works with humidity to damage paper. Heat causes the moisture in paper to evaporate, while cold causes it to condense on the sheets. Heating systems and air conditioners remove most of the humidity from a room. As paper is opened and used, it loses moisture, causing streaks and smudging. Humid weather or water coolers can cause the humidity to increase in a room. As paper is opened and used it absorbs any excess moisture, causing light print and dropouts. Also, as paper loses and gains moisture it can distort. This issue can cause jams.

As a result, paper storage and handling are as important as the paper-making process itself. Paper storage environmental conditions directly affect the feed operation and print quality.

Care should be taken not to purchase more paper than can be easily used in a short time (about three months). Paper stored for long periods can experience heat and moisture extremes, which can cause damage. Planning is important to prevent damage to a large supply of paper.

Unopened paper in sealed reams can remain stable for several months before use. Opened packages of paper have more potential for environmental damage, especially if they are not wrapped with a moisture-proof barrier.

The media-storage environment should be properly maintained to ensure optimum printer performance. The required condition is 20° to 24°C (68° to 75°F), with a relative humidity of 45% to 55%. The following guidelines should be helpful when evaluating the paper's storage environment:

- Print media should be stored at or near room temperature.
- The air should not be too dry or too humid (to moderate the hygroscopic properties of paper).
- The best way to store an opened ream of paper is to rewrap it tightly in its moisture-proof wrapping. If the printer environment is subject to extremes, unwrap only the amount of paper to be used during the day's operation to prevent unwanted moisture changes.
- Avoid storing paper and print media near heating and air conditioning vents or near windows and doors that are frequently open.

Envelopes

Envelopes can be printed from Tray 1 or Tray 2. Select the type of envelope that you are using from the **Print** dialog box or the printer driver.

In your program, set the margins for the envelope. The following table gives typical address margins for a commercial #10 or DL envelope.

Type of address	Top margin	Left margin
Return address	15 mm (0.6 inch)	15 mm (0.6 inch)
Delivery address	51 mm (2 inches)	89 mm (3.5 inches)

- For the best print quality, position margins no closer than 15 mm (0.6 inch) from the edges of the envelope.
- Avoid printing over the area where the envelope seams meet.

Envelope storage

Proper storage of envelopes helps contribute to print quality. Envelopes should be stored flat. If air is trapped in an envelope and creates an air bubble, then the envelope might wrinkle during printing.

For more information, see [Printing on envelopes](#).

Envelope construction

Envelope construction is critical. Envelope fold lines can vary considerably, not only between manufacturers, but also within a box from the same manufacturer. Successful printing on envelopes depends upon the quality of the envelopes. When selecting envelopes, consider the following components:

- **Weight:** The weight of the envelope paper should not exceed 90 g/m² (24 lb) or jamming might occur.
- **Construction:** Before printing, envelopes should lie flat with less than 6 mm (0.25 inch) curl, and should not contain air.
- **Condition:** Envelopes should not be wrinkled, nicked, or otherwise damaged.
- **Temperature:** Use envelopes that are compatible with the heat and pressure of the printer. This printer's fusing temperature is 210°C (410°F).
- **Size:** Use only envelopes that are within the following size ranges.

Tray	Minimum	Maximum
Tray 1 or Tray 2	76 x 127 mm (3 x 5 inches)	216 x 356 mm (8.5 x 14 inches)

Envelopes with double side-seams

Double side-seam construction has vertical seams at both ends of the envelope rather than diagonal seams. This style might be more likely to wrinkle. Be sure the seam extends all the way to the corner of the envelope as illustrated below.

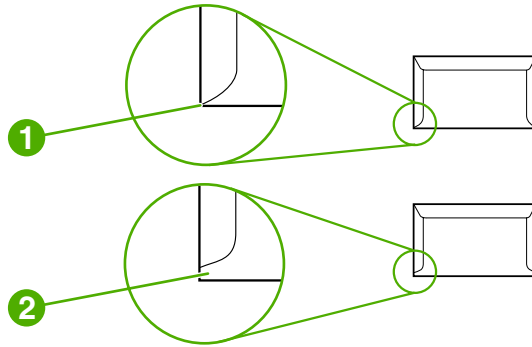

- 1 Acceptable
- 2 Unacceptable

Envelopes with adhesive strips or flaps

Envelopes with a peel-off adhesive strip or with more than one flap that folds over to seal must use adhesives that are compatible with the heat and pressure in the printer. The extra flaps and strips might cause wrinkling, creasing, or even jams and might damage the fuser.

Labels

Select the type of label that you are using from the **Print** dialog box or the printer driver.

CAUTION

To avoid damaging the printer, use only labels that are recommended for laser printers. To prevent serious jams, always use Tray 1 or Tray 2 to print on labels. Never print on the same sheet of labels more than once or print on a partial sheet of labels.

When selecting labels, consider the quality of each component:

- **Adhesives:** The adhesive material should be stable at 210°C (410°F), which is the printer fusing temperature.
- **Arrangement:** Only use labels with no exposed backing between them. Labels can peel off sheets with spaces between the labels, causing serious jams.
- **Curl:** Before printing, labels must lie flat with no more than 13 mm (0.5 inch) of curl in any direction.
- **Condition:** Do not use labels that have wrinkles, bubbles, or other indications of separation.

For more information, see [Printing on labels](#).

Transparencies

Use only Tray 1 or Tray 2 to print on transparencies. Select **Transparencies** from the **Print** dialog box or the printer driver.

The printer supports printing on color transparencies. Use only transparencies that are recommended for use in laser printers.

Transparencies that are used in the printer must be able to withstand 210°C (410°F), which is the printer fusing temperature.

CAUTION

To avoid damage to the printer, use only transparencies that are recommended for use in laser printers. See [Accessories and ordering information](#).

For more information, see [Transparencies](#).

Supported media weights and sizes

This section contains information about the sizes, weights, and capacities of paper and other print media that each tray supports.

Tray 1 and Tray 2 specifications

Tray 1 and Tray 2	Dimensions ¹	Weight	Capacity ²	
Paper	Minimum: 76 x 127 mm (3 x 5 inches)	60 to 163 g/m ² (16 to 43 lb) Up to 176 g/m ² (47 lb) for postcards	Single sheet of 75 g/m ² (20 lb) paper for Tray 1 Up to 250 sheets for Tray 2	
	Maximum: 216 x 356 mm (8.5 x 14 inches)			
HP LaserJet glossy paper and HP LaserJet photo paper	Same as the preceding listed minimum and maximum sizes.	75 to 163 g/m ² (20 to 32 lb)	Single sheet of HP LaserJet glossy paper or HP LaserJet photo paper for Tray 1 Up to 25 mm (0.99 inch)stack height for Tray 2	
HP Premium Cover paper ⁴		200 g/m ² (75 lb) cover	Single sheet of HP Cover paper for Tray 1 Up to 25 mm (0.99 inch)stack height for Tray 2	
Transparencies and opaque film		Thickness: 0.10 to 0.13 mm (3.9 to 5.1 mils)	Single sheet of transparency or opaque film for Tray 1 Up to 50 sheets for Tray 2	
Labels ³		Thickness: up to 0.23 mm (up to 9 mils)	Single sheet of labels for Tray 1 Up to 25 mm (0.99 inch)stack height for Tray 2	
Envelopes			Up to 90 g/m ² (16 to 24 lb)	Single envelope for Tray 1 Up to ten envelopes for Tray 2

¹ The printer supports a wide range of standard and custom sizes of print media. Check the printer driver for supported sizes.

² Capacity can vary depending on media weight and thickness, and environmental conditions.

³ Smoothness: 100 to 250 (Sheffield).

⁴ Hewlett-Packard does not guarantee results when printing with other types of heavy paper.

Optional Tray 3 specifications

Optional Tray 3 (250-sheet tray)	Dimensions ¹	Weight	Capacity ²
Plain paper	Minimum: 76 x 127 mm (3 x 5 inches)	60 to 163 g/m ²	Up to 250 sheets
	Maximum: 216 x 356 mm (8.5 x 14 inches)		

¹ The printer supports a wide range of standard and custom sizes of print media. Check the printer driver for supported sizes.

² Capacity can vary depending on the media weight and thickness, and environmental conditions.

2

Control panel

This section provides information about the control panel features.

Control panel features

The printer contains the following lights and buttons on the control panel:

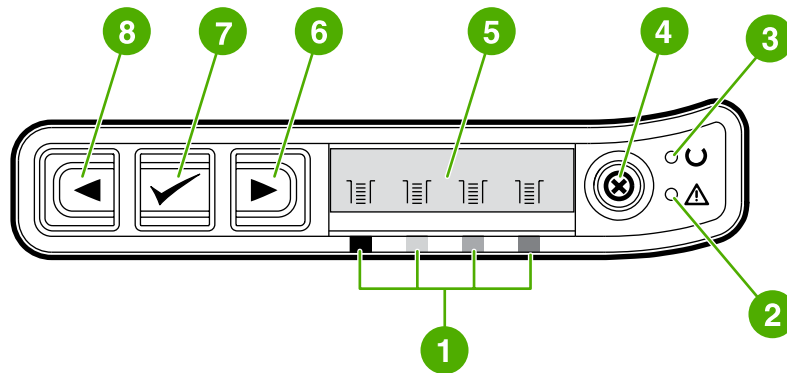

- 1 Color print cartridge indicators
- 2 Attention light (amber)
- 3 Ready light (green)
- 4 CANCEL JOB  button
- 5 Message area
- 6 RIGHT ARROW  button
- 7 SELECT  button
- 8 LEFT ARROW  button

Display

The printer's display gives you information about the printer, job status, and levels of supplies.

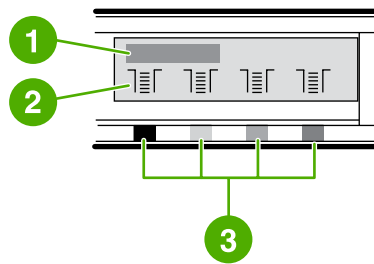

- 1 Message area
- 2 Supplies gauges
- 3 Print cartridge colors are indicated from left to right: black, yellow, cyan, and magenta

Understanding Supplies Status

The supplies gauges show the consumption levels of print cartridges (black, yellow, cyan, and magenta).

Black, Yellow, Cyan, and Magenta Supplies Status gauges

A ? appears instead of the consumption level when the level is not known. This can occur in the following circumstances:



- Missing cartridges
- Incorrectly placed cartridges
- Cartridges with an error
- Some non-HP cartridges

The supplies gauge appears whenever the printer shows the Ready state with no warnings. It will also appear when the printer shows a warning or error message concerning a print cartridge or multiple supplies. If a supply is empty, the gauge will flash.

Understanding Printer Status

The printer has four buttons and two lights to indicate and control the printer status.

Cancel Job button

- When the Ready light is blinking, pressing  (CANCEL JOB) cancels the current job.
- When a Supplies Status gauge is blinking and the Attention light is on (indicating that a non-HP supply has been installed), pressing  (SELECT) allows you to continue printing.

CAUTION

You might not receive any indication when a non-HP supply is empty. If you continue printing after the supply is empty, damage to the printer can occur. See [Hewlett-Packard limited warranty statement](#).

Attention light



Generally, the Attention light blinks when the printer is out of paper, when a jam has occurred, or when other problems that need attention occur.

The Attention light is on and one of the Supplies Status gauges is blinking the first time a non-HP supply is installed.

Ready light

The Ready light is on when the printer is ready to print (experiencing no errors that prevent printing) and blinks when it is receiving data to be printed.

Ready light and Select button

- When the Ready light is on and the Attention light is blinking, pressing  (SELECT) continues the print job after you load print media for a manual feed, or clears some errors.
- When the Ready light is blinking, the front door has been opened and then closed. Press  (SELECT) to return the printer to the Ready state. If you do not press  (SELECT), the printer returns to the Ready state on its own.

Left and Right arrow buttons

Use the  (LEFT ARROW) and  (RIGHT ARROW) buttons to navigate through the printer control panel menus.

A Demo page can be printed by pressing the  (LEFT ARROW) and  (RIGHT ARROW) buttons simultaneously.

3

Networking

This section provides information about using your printer on a network.

- [To configure a network port-connected device configuration \(direct mode or peer-to-peer printing\)](#)
- [Supported network protocols](#)
- [TCP/IP configuration](#)
- [Using BOOTP/TFTP](#)
- [Using DHCP](#)
- [To discontinue DHCP configuration](#)
- [Using the printer control panel](#)
- [Using the embedded Web server](#)

NOTE

Configuring TCP/IP settings are complicated and should only be performed by experienced network administrators. BOOTP will require a (PC, Unix, Linux, and so on.) server to configure specific TCP/IP settings for the product. DHCP will also require a server, but the TCP/IP settings will not be fixed for the device. Finally, the manual method to configure specific TCP/IP settings can be done from the control panel.

To configure a network port-connected device configuration (direct mode or peer-to-peer printing)

In this configuration, the device is connected directly to the network, and all computers on the network print directly to the device.

NOTE

This mode is the recommended network configuration for the device.

1. Connect the device directly to the network by inserting a network cable into the device network port.
2. Turn on the printer. Allow 1-2 minutes for the printer to acquire an IP address.
3. At the device, use the control panel to print a Configuration page. See [Configuration page](#).
4. Insert the device CD-ROM into your computer. The software installer will automatically run. If the software installer does not start, navigate to the setup.exe file on the CD-ROM and double-click the file.
5. On the **Welcome** screen, click **Next**.
6. On the **License Agreement** screen, read the license agreement, indicate that you accept the terms, and then click **Next**.
7. Select **connected via the Network** and then click **Next**.
8. To identify the printer, select **search from a list of detected printers**, select and highlight the printer/IP address that matches the IP address on the printed Configuration page, and then click **Next**.
9. On the **Ready to Install** screen, click **Next** to begin installation.

NOTE

If you want to change your settings, instead of clicking **Next**, click **Back** to return to previous screens, and then change the settings.

10. Allow the installation process to complete and then restart the computer to complete.

Supported network protocols

The HP Color LaserJet 2600n printer supports the TCP/IP network protocol. It is the most widely used and accepted networking protocol. Many networking services utilize this protocol. The following table lists the networking services/protocols that are supported on the HP Color LaserJet 2600n printer.

The following operating systems support network printing:

- Windows 2000
- Windows XP
- Macintosh OS X v10.2 and later

Printing

Service name	Description
port9100 (Direct Mode)	Printing service

Network device discovery

Service name	Description
SLP (Service Location Protocol)	Device Discovery Protocol, used to help find and configure network devices. Used primarily by Microsoft based applications.
mDNS (multicast Domain Name Service - commonly referred to as Rendezvous)	Device Discovery Protocol, used to help find and configure network devices. Used primarily by Apple Macintosh based Applications.

Messaging and management

Service name	Description
HTTP (Hyper Text Transfer Protocol)	Allows web browsers to communicate with embedded Web server.
EWS (embedded Web server)	Allows a user to manage the device through a web browser.
SNMP (Simple Network Management Protocol)	Used by network applications for device management. SNMP v1/v2 and standard MIB-II (Management Information Base) objects are supported.

IP Addressing

Service name	Description
DHCP (Dynamic Host Configuration Protocol)	For Automatic IP address assignment. DHCP server provides device with IP address. Generally requires no user intervention for printer to obtain IP address from a DHCP server.
BOOTP (Bootstrap Protocol)	For Automatic IP address assignment. BOOTP server provides device with IP address. Requires administrator to input devices MAC hardware address on BOOTP server in order for printer to obtain an IP address from that server.

TCP/IP configuration

To operate properly on a TCP/IP network, the printer must be configured with valid TCP/IP network configuration parameters, such as an IP address that is valid for your network.

Server-based, AutoIP, and manual TCP/IP configuration

When in a factory-default state and powered on, the printer will first try to obtain its TCP/IP configuration using a server-based method, such as BOOTP or DHCP. If the server-based method fails, the printer will then be configured using the AutoIP protocol. The printer may also be configured manually. Manual-based tools include a Web browser, the printer control panel, the HP Toolbox utility, or SNMP-based management software (such as HP Web Jetadmin). TCP/IP configuration values assigned manually will be retained when the printer is powered off/on. The printer can also be reconfigured to use either server-based only (BOOTP and/or DHCP), or AutoIP only, or manual configuration of TCP/IP settings at any time.

Server-based TCP/IP configuration

In its factory-default state, the printer will first try DHCP, if this fails it will then try BOOTP, if this fails, it will then obtain an IP address via AutoIP. In addition, a default IP address will not be assigned if a network cable is not attached to the printer.

Default IP address configuration

A default IP address will be assigned via the AutoIP protocol if the server based methods fail. When DHCP or BOOTP fails to obtain an IP address, the printer uses a link-local addressing technique to assign a unique IP address. Link-local addressing may be referenced as AutoIP. The IP address assigned will be in the range of 169.254.1.0 to 169.254.254.255 (commonly referenced as 169.254/16), and should be valid. However, it can be further modified for your network using supported TCP/IP configuration tools if necessary. With link-local addresses, subnetting is not used. The subnet mask will be 255.255.0.0, and cannot be changed. Link-local addresses will not route off the local link, and access to or from the Internet will not be available. The default gateway address will be the same as the link-local address. If a duplicate address is sensed, the printer will automatically reassign its address, if necessary, in accordance with standard link-local addressing methods. The IP address configured on your printer may be determined by inspecting the network configuration page for the printer. Since it may take some time for the server-based protocols to time out, the AutoIP process can be sped up by disabling the BOOTP and DHCP services on the printer. This can be done via a Web browser.

TCP/IP configuration tools

Depending on your printer and operating system, the printer can be configured with valid TCP/IP parameters for your network in the following ways:

- Using Software—You can use your printer installation software on HP Toolbox.
- BOOTP—You can download the data from a network-based server using BOOTP (Bootstrap Protocol) each time the printer is turned on. The BOOTP daemon, `bootpd`, must be running on a BOOTP server that is accessible by the printer.
- DHCP—You can use Dynamic Host Configuration Protocol (DHCP). This protocol is supported in HP-UX, Solaris, Red Hat Linux, SuSE Linux, Windows NT/2000/XP, NetWare and Mac systems. (Refer to your network operating system manuals to verify that your server operating system supports DHCP.)

NOTE

Linux and UNIX systems: For more information, see the `bootpd` man page. On HP-UX systems, a sample DHCP configuration file (`dhcptab`) may be located in the `/etc` directory. Since HP-UX presently does not provide Dynamic Domain Name Services (DDNS) for its DHCP implementations, HP recommends that you set all printer lease durations to **infinite**. This ensures that printer IP addresses remain static until such time as Dynamic Domain Name Services are provided.

Using BOOTP/TFTP

BOOTP (Bootstrap Protocol) provides a convenient way to automatically configure the printer for TCP/IP network operation. When powered on, printer sends a BOOTP request message onto the network. A properly configured BOOTP server on the network will respond with a message that contains basic network configuration data for printer. The BOOTP server's response may also identify a file that contains extended configuration data for the print server. The TFTP protocol (which is not a supported feature for this printer) is required to download this. Thus, the TFTP configuration file that may be located on the BOOTP server, or a separate TFTP server will be ignored. BOOTP servers are typically UNIX or Linux systems. Windows NT/2000/XP and NetWare servers can respond to BOOTP requests. Windows NT/2000/XP servers are configured through Microsoft DHCP services. For setup of NetWare BOOTP servers, refer to your NetWare documentation.

NOTE

If the printer and the BOOTP/DHCP server are located on different subnets, IP configuration may fail unless the routing device supports "BOOTP Relay" (allows the transfer of BOOTP requests between subnets).

Why Use BOOTP?

Using BOOTP to download configuration data has the following benefits:

- Enhanced configuration control of the printer. Configuration by other methods, such as a printer control panel, are limited to select parameters.
- Ease of configuration management. Network configuration parameters for the entire network can be in one location.
- Ease of printer configuration. Complete network configuration can be automatically downloaded each time the print server is powered on.

NOTE

BOOTP operation is similar to DHCP, but the resulting IP parameters will be the same when powered off/on. In DHCP, IP configuration parameters are leased and may change over time. When in its factory-default state and powered on, the printer will attempt to automatically configure itself using several dynamic methods, one of which is BOOTP.

BOOTP on UNIX

This section describes how to configure the print server using BOOTP (Bootstrap Protocol) services on UNIX servers. BOOTP is used to download network configuration data from a server to the printer over the network.

Systems That Use Network Information Service (NIS)

If your system uses NIS, you may need to rebuild the NIS map with the BOOTP service before performing the BOOTP configuration steps. Refer to your system documentation.

Configuring the BOOTP Server

For the printer to obtain its configuration data over the network, the BOOTP server must be set up with the appropriate configuration files. BOOTP is used by the print server to obtain entries in the `/etc/bootptab` file on a BOOTP server. When the printer is powered on, it broadcasts a BOOTP request that contains its MAC (hardware) address. A BOOTP server daemon searches the `/etc/bootptab` file for a matching MAC address, and if successful, sends the corresponding configuration data to the printer as a BOOTP reply. The configuration data in the `/etc/bootptab` file must be properly entered. The BOOTP reply may contain the name of a configuration file containing optional enhanced configuration parameters. Again, this file will be ignored by the printer.

NOTE

HP recommends that the BOOTP server be located on the same subnet as the printers it serves.

NOTE

BOOTP broadcast packets may not be forwarded by routers unless the routers are properly configured.

Bootptab File Entries

An example of a `/etc/bootptab` file entry for a networked printer is shown below. Note that the configuration data contains tags to identify the various printer parameters and their settings.

Entries and tags supported are listed in the [Tags Supported in a BOOTP/DHCP Boot file](#) table.

```
picasso:\
:hn:\
:ht=ether:\
:vm=rfc1048:\
:ha=0001E6123456:\
:ip=192.168.40.39:\
:sm=255.255.255.0:\
:gw=192.168.40.1:\
:lg=192.168.40.3:\
:T144="hnp/picasso.cfg":
```

Tags Supported in a BOOTP/DHCP Boot file

Option	Description
Nodename	The name of the peripheral. This name identifies an entry point to a list of parameters for a specific peripheral. Nodename must be the first field in an entry. (In the example above, nodename is "picasso".)
ht	The hardware type tag. For the printer, set this to ether for Ethernet. This tag must precede the ha tag.
vm	The BOOTP report format tag (required). Set this parameter to rfc1048 .

Tags Supported in a BOOTP/DHCP Boot file (continued)

Option	Description
ha	The hardware address tag. The hardware (MAC) address is the link-level, or station address of the printer. It can be found on the printer network configuration page as the HARDWARE ADDRESS .
ip	The IP address tag (required). This address will be the printer's IP address.
sm	The subnet mask tag. The subnet mask will be used by the printer to identify the portions of an IP address that specify the network/subnetwork number and the host address.
gw	The gateway IP address tag. This address identifies the IP address of the default gateway (router) that the printer will use for communications with other subnets.
ds	DNS (Domain Name System) server's IP address tag. Only a single name server can be specified.
lg	The syslog server's IP address tag. It specifies the server that the printer sends syslog messages to.
hn	The host name tag. This tag does not take a value but causes the BOOTP daemon to download the host name to the printer. The host name will be printed on the printer network configuration page, or returned an SNMP sysName request by a network application.
dn	Domain name tag. Specifies the domain name for the printer (for example, support.hp.com). It does not include the host name; it is not the Fully Qualified Domain Name (such as printer1.support.hp.com).
tr	DHCP T1 timeout, specifying the DHCP lease renewal time (seconds).
tv	DHCP T2 timeout, specifying the DHCP lease rebind time (seconds).

NOTE

A colon (:) indicates the end of a field, and a backslash (\) indicates that the entry is continued on the next line. Spaces are not allowed between the characters on a line. Names, such as host names, must begin with a letter and can contain only letters, numbers, periods (for domain names only), or hyphens. The underline character () is not allowed. Refer to your system documentation or online help for more information.

Using DHCP

Dynamic Host Configuration Protocol (DHCP, RFC 2131/2132) is one of several auto configuration mechanisms that the printer uses. If you have a DHCP server on your network, the printer automatically obtains its IP address from that server and registers its name with any RFC 1001 and 1002-compliant dynamic name services as long as a WINS (Windows Internet Naming Service) server IP address has been specified.

NOTE

DHCP services must be available on the server. Refer to your system documentation or online help to install or enable DHCP services.

NOTE

If the printer and BOOTP/DHCP server are located on different subnets, IP configuration may fail unless the routing device allows the transfer of DHCP requests between subnets.

UNIX Systems

For more information on setting up DHCP on UNIX systems, see the `bootpd` man page. On HP-UX systems, a sample DHCP configuration file (`dhcptab`) may be located in the `/etc` directory. Since HP-UX presently does not provide Dynamic Domain Name Services (DDNS) for its DHCP implementations, HP recommends that you set all print server lease durations to **infinite**. This ensures that print server IP addresses remain static until Dynamic Domain Name Services are provided.

Windows Systems

The printer supports IP configuration from a Windows NT/2000/XP DHCP server. This section describes how to set up a pool, or “scope,” of IP addresses that the Windows server can assign or lease to any requester. When configured for BOOTP or DHCP operation and powered on, the printer automatically sends a BOOTP or DHCP request for its IP configuration. If properly set up, a Windows DHCP server will respond with the print server’s IP configuration data.

NOTE

This information is provided as an overview. For specific information or for additional support, see the information supplied with your DHCP server software.

NOTE

To avoid problems resulting from IP addresses that change, HP recommends that all printers be assigned IP addresses with infinite leases or reserved IP addresses.

Windows NT 4.0 Server

To set up a DHCP scope on a Windows NT 4.0 server, perform the following steps:

1. At the Windows NT server, open the Program Manager window and double-click the **Network Administrator** icon.
2. Double-click the **DHCP Manager** icon to open this window.
3. Select **Server** and select **Server Add**.
4. Type the server IP address, then click **OK** to return to the DHCP Manager window.
5. In the list of DHCP servers, click on the server you have just added, then select **Scope** and select **Create**.
6. Select **Set up the IP Address Pool**. In the IP Address Pool section, set up the IP address range by typing the beginning IP address in the Start Address box and the ending IP address in the End Address box. Also type the subnet mask for the subnet to which the IP address pool applies. The starting and ending IP addresses define the end points of the address pool assigned to this scope.

NOTE

If desired, you can exclude ranges of IP addresses within a scope.

7. In the Lease Duration section, select **Unlimited**, then select **OK**. HP recommends that all printers be assigned infinite leases to avoid problems resulting from IP addresses that change. Be aware, however, that selecting an unlimited lease duration for the scope causes all clients in that scope to have infinite leases. If you want clients on your network to have finite leases, you can set the duration to a finite time, but you should configure all printers as reserved clients for the scope.
8. Skip this step if you have assigned unlimited leases in the previous step. Otherwise, select **Scope** and select **Add Reservations** to set up your printers as reserved clients. For each printer, perform the following steps in the Add Reserved Clients window to set up a reservation for that printer:
 - a. Type the selected IP address.
 - b. Obtain the MAC address or hardware address from the configuration page, and type this address in the Unique Identifier box.
 - c. Type the client name (any name is acceptable).
 - d. Select **Add** to add the reserved client. To delete a reservation, in the DHCP Manager window, select **Scope** and select **Active Leases**. In the Active Leases window, click on the reservation you want to delete and select **Delete**.
9. Select **Close** to return to the DHCP Manager window.
10. Skip this step if you are not planning to use WINS (Windows Internet Naming Service). Otherwise perform the following steps when configuring your DHCP server:
 - a. From the DHCP Manager window, select DHCP Options and select one of the following:
 - Scope—if you want Name Services only for the selected scope.
 - Global—if you want Name Services for all scopes.
 - b. Add the server to the Active Options list. From the DHCP Options window, select **WINS/NBNS Servers (044)** from the Unused Options list. Select **Add**, then select **OK**. A warning may appear requesting that you set the node type. You do this in step 10d.

- c. You must now provide the IP address of the WINS server by doing the following:
 - Select **Value**, then **Edit Array**.
 - From the IP Address Array Editor, select **Remove** to delete any undesired addresses previously set. Then type in the IP address of the WINS server and select **Add**.
 - Once the address appears in the list of IP addresses, select **OK**. This returns you to the DHCP Options window. If the address you have just added appears in the list of IP addresses (near the bottom of the window) go to step 10d. Otherwise, repeat step 10c.
 - d. In the DHCP Options window, select **WINS/NBT Node Type (046)** from the **Unused Options** list. Select **Add** to add the node type to the **Active Options** list. In the Byte box, type 0x4 to indicate a mixed node, and select **OK**.
11. Click **Close** to exit to Program Manager.

Windows 2000 Server

To set up a DHCP scope on a Windows 2000 server, perform the following steps:

1. Run the Windows 2000 DHCP manager utility. Click **Start**, then select **Settings** and **Control Panel**. Open the **Administrative Tools** folder and run the DHCP utility.
2. In the DHCP window, locate and select your Windows 2000 server in the DHCP tree. If your server is not listed in the tree, select **DHCP** and click the **Action** menu to add the server.
3. After selecting your server in the DHCP tree, click the **Action** menu and select **New Scope**. This runs the Add New Scope Wizard.
4. In the Add New Scope Wizard, click **Next**.
5. Enter a Name and Description for this scope, then click **Next**.
6. Enter the range of IP addresses for this scope (beginning IP address and ending IP address). Also, enter the subnet mask. Then click **Next**.

NOTE

If subnetting is used, the subnet mask defines which portion of an IP address specifies the subnet and which portion specifies the client device.

7. If applicable, enter the range of IP addresses within the scope to be excluded by the server. Then click **Next**.
8. Set the IP address lease duration for your DHCP clients. Then click **Next**. HP recommends that all printers be assigned reserved IP addresses. This can be accomplished after you set up the scope (see step 11).
9. To configure DHCP options for this scope later, select **No** and then click **Next**. To configure DHCP options now, select **Yes** and click **Next**.
 - a. If desired, specify the IP address of the router (or default gateway) to be used by clients. Then click **Next**.
 - b. If desired, specify the Domain Name and DNS (Domain Name System) servers for clients. Click **Next**.
 - c. Select **Yes** to activate the DHCP options now, and click **Next**.
10. You have successfully set up the DHCP scope on this server. Click **Finish** to close the wizard.
11. Configure your printer with a reserved IP address within the DHCP scope:

- a. In the DHCP tree, open the folder for your scope and select **Reservations**.
- b. Click the **Action** menu and select **New Reservation**.
- c. Enter the appropriate information in each field, including the reserved IP address for your printer.

NOTE

The MAC address for your printer is available on the printer's network configuration page.

- d. Under Supported types, select **DHCP only**, then click **Add**.

NOTE

Selecting Both or BOOTP only will result in a configuration through BOOTP due to the sequence in which the printer initiates configuration protocol requests.

- e. Specify another reserved client, or click **Close**. The reserved clients added will be displayed in the Reservations folder for this scope.

12. Close the DHCP manager utility.

NetWare systems

NetWare 5.x servers provide DHCP configuration services for network clients, including your HP printer. To set up DHCP services on a NetWare server, refer to Novell documentation and support.

To discontinue DHCP configuration

CAUTION

Changes to an IP address on your printer may require updates to printer or system printing configurations for clients or servers. If you do not want your printer configured through DHCP, you must reconfigure the printer with a different configuration method. You can manually modify the TCP/IP parameters through a supported Web browser using the printer's embedded Web server, the printer's control panel, or HP Toolbox. If you change to BOOTP configuration, the DHCP-configured parameters are released and the TCP/IP protocol is initialized. If you change to Manual configuration, the DHCP-configured IP address is released and the user-specified IP parameters are used. **Therefore, if you manually provide the IP address, you should also manually set all of the configuration parameters, such as subnet mask and default gateway.**

Using the printer control panel

The HP Color LaserJet 2600n printer allows you to set up an IP address automatically using BOOTP or DHCP. For more information, see [Default IP address configuration](#).

To configure the IP address manually from the printer control panel, see [Configure a static IP address for my printer](#).

Using the embedded Web server

You can use the embedded Web server to view or change your IP configuration settings. To do this, open the embedded Web server and click on the Networking tab. See [Using the embedded Web server](#).

From the Networking tab, you can change the following configurations:

- Host Name
- Manual IP Address
- Manual Subnet Mask
- Manual Default Gateway
- Manual WINS Server

NOTE

Changing the network configuration may require you to change the browser URL before you can communicate with the printer again. The printer will be unavailable for a few seconds while the network resets.

4

Printing tasks

This section provides information about common printing tasks.

- [Loading trays](#)
- [Printing on special media](#)
- [Controlling print jobs](#)
- [Printing on both sides](#)
- [Canceling a print job](#)

For information about managing the printer and its settings by using the HP Toolbox, see [Maintenance](#).

Loading trays

Use special print media, such as envelopes, labels, HP LaserJet glossy paper, HP LaserJet Photo paper, and transparencies in Tray 1 and Tray 2.

Loading Tray 1

Tray 1 (the single sheet priority feed slot) prints single sheets of print media or a single envelope. Use Tray 1 when feeding one sheet of paper, envelope, postcard, label, HP LaserJet glossy paper, HP LaserJet Photo paper, or transparency. You can also use Tray 1 to print the first page on different media than the rest of the document.

For information about loading special print media such as envelopes, labels, and transparencies, see [Printing on special media](#).

To load Tray 1

1. Media guides ensure that the media is correctly fed into the printer and that the print is not skewed (crooked on the media). Slide the media-width guides slightly wider than the print media.

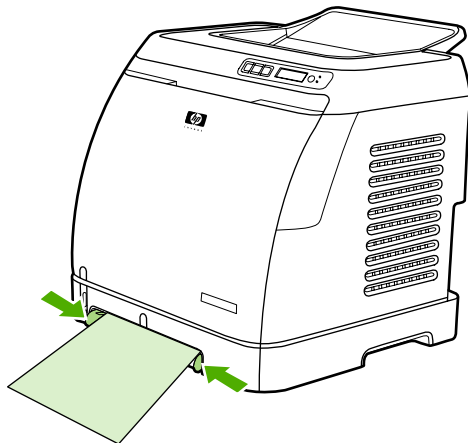

2. Feed print media into Tray 1 with the side to be printed down, and the top, short edge in first. Make sure that the media is inserted far enough into the printer for the paper feed mechanism to grab the media.

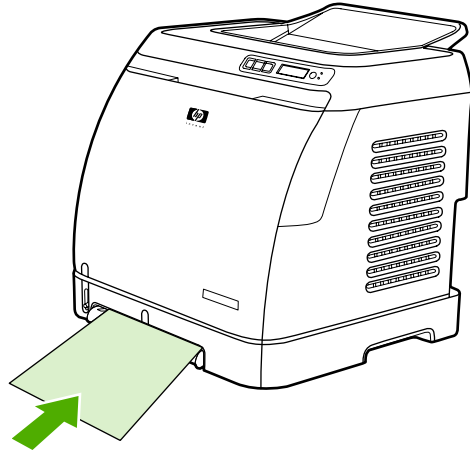

NOTE

If you are printing on both sides, see [Printing on both sides](#) for loading instructions.

Loading Tray 2 or optional Tray 3

Tray 2 and optional Tray 3 are accessed from the front of the printer and hold up to 250 sheets of paper. Tray 2 also supports other media such as envelopes, postcards, transparencies, HP LaserJet glossy paper, and HP LaserJet Photo paper.

CAUTION

Do not fan paper before loading it into trays. Avoid overloading trays.

CAUTION

Avoid reusing paper that has been stapled. Staples left in reused paper will cause printer damage that will require repairs that may not be covered under the warranty.

To load Tray 2 or optional Tray 3

NOTE

Instructions are the same for loading media in Tray 2 and optional Tray 3.

1. Pull Tray 2 or optional Tray 3 out of the printer and remove any paper.

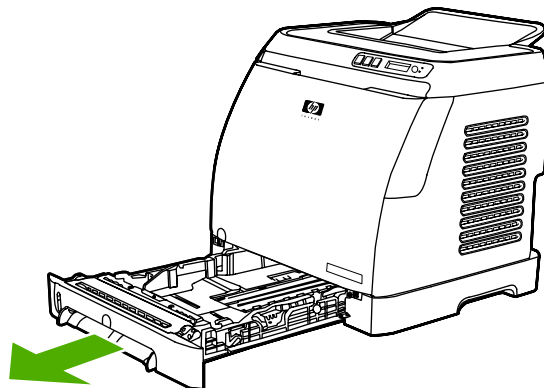

2. Move the rear guides to match the size of paper that you are loading. Tray 2 and optional Tray 3 accept several standard paper sizes.

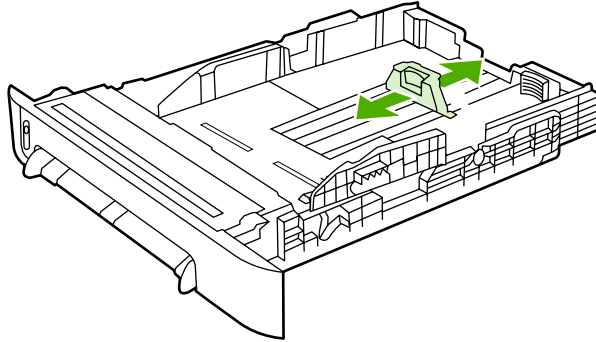

3. If printing paper longer than Letter/A4, extend the rear of the tray until it matches the size you are loading.

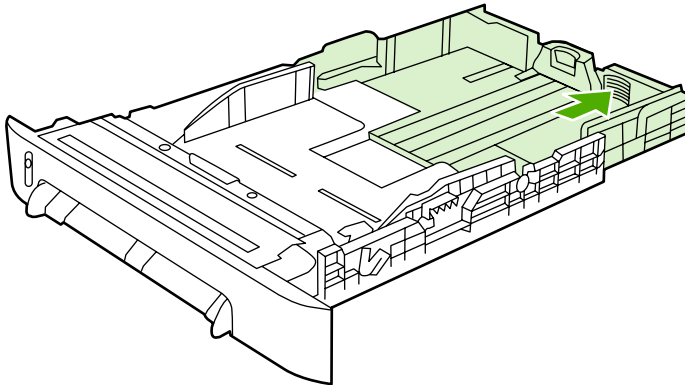

4. Slide the media-width guides slightly wider than the print media.

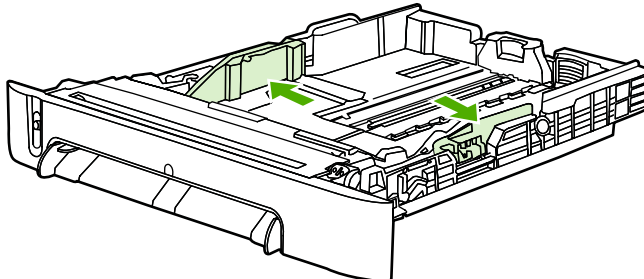

5. Load the paper. If this is special paper such as letterhead, load it with the side to be printed on facing up and the top edge toward the front of the tray.

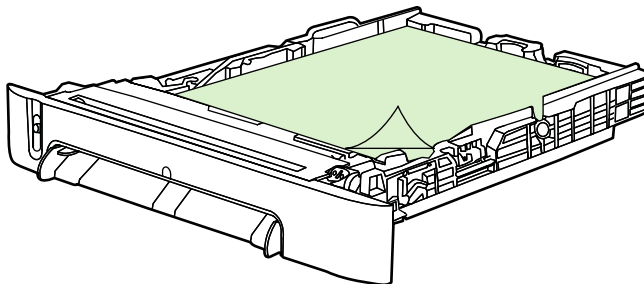

NOTE

If you print using the Print on Both Sides (manually) feature, see [Printing on both sides](#) for loading instructions.

6. Make sure that the stack of paper is flat in the tray at all four corners, and keep it below the height tabs on the media-length guide in the rear of the tray.

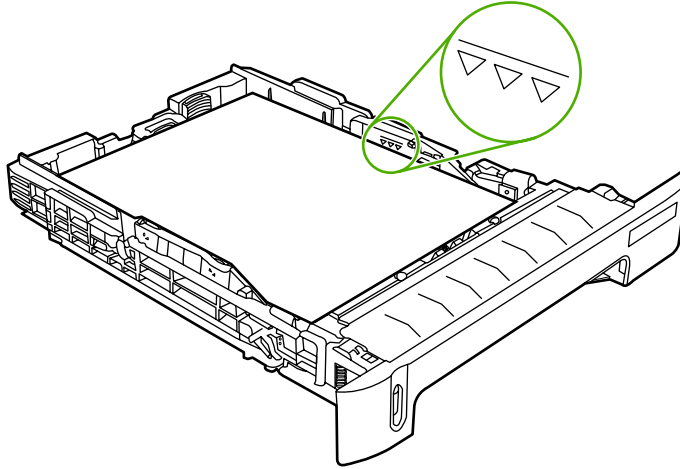

7. Slide the tray into the printer. The back of the tray will protrude from the back of the printer.

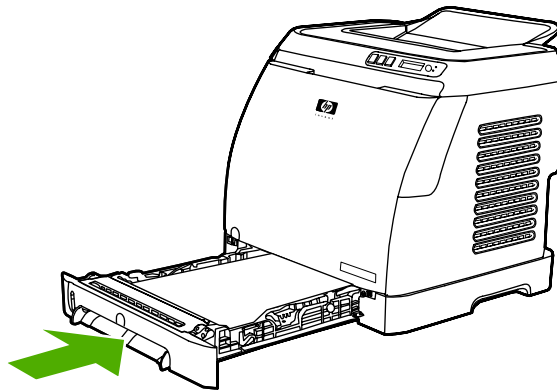

Printing on special media

If printing on a special type of media, printing speeds might be automatically reduced to improve the output quality for that specific media.

Use these guidelines when printing on special types of media.

Printing on envelopes

Use only envelopes that are recommended for laser printers. See [Print-media specifications](#) for more information.

- Load a single envelope into Tray 1 or up to ten envelopes in Tray 2.
- Do not load more than ten envelopes into Tray 2.
- The weight of the envelope paper should not exceed 90 g/m² (24 lb).
- Make sure that envelopes are not damaged and are not stuck together.
- Never use envelopes that have clasps, snaps, windows, coated linings, self-stick adhesives, or other synthetic materials.
- If you are using a non-standard size of envelope, select the appropriate envelope as the Type. For more information, see [Printing on custom-sized print media or cardstock](#).

CAUTION

Failure to follow the guidelines above can result in jams.

For more information, see [Print-media specifications](#).

To print on envelopes from Tray 1

1. Adjust the side-width guides.

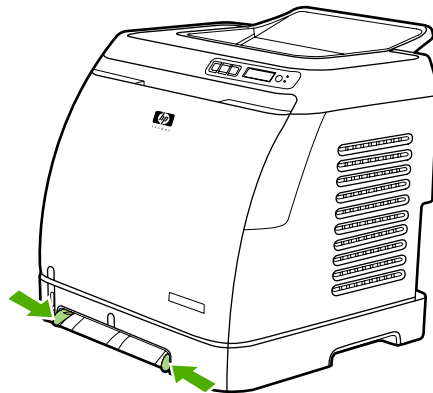

2. Insert an envelope into Tray 1, with the short edge leading into the printer and the flap on the right side facing up. Make sure that the envelope is inserted far enough into the printer for the paper feed mechanism to grab the envelope.

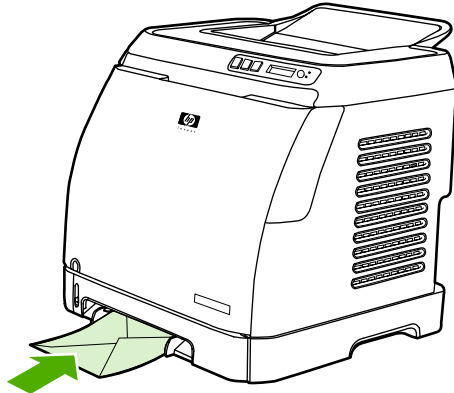

To print on envelopes from Tray 2

1. Open Tray 2 and slide out the extender fully. If Tray 2 is already loaded, remove any paper or other print media from it.

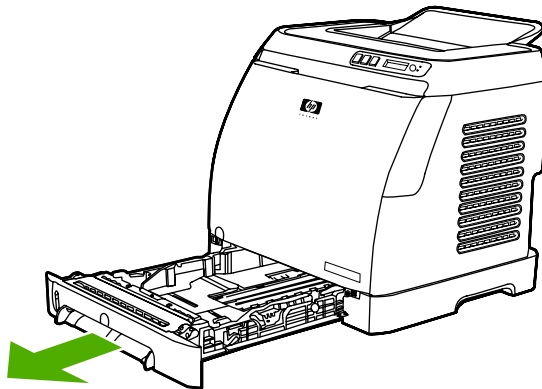

2. Slide the side-width guides in Tray 2 outward until they are slightly wider than the envelopes.

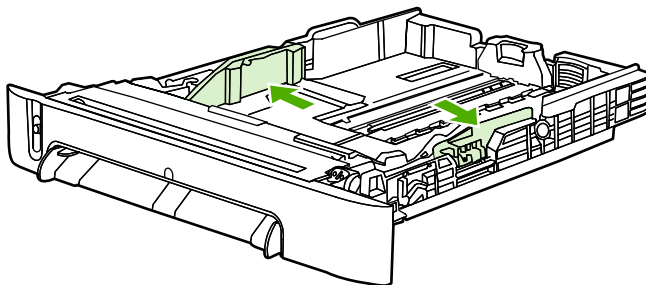

3. Place the stack of envelopes into the tray with the flaps on the right side, the side to be printed facing up, and with the short edge leading into the printer.

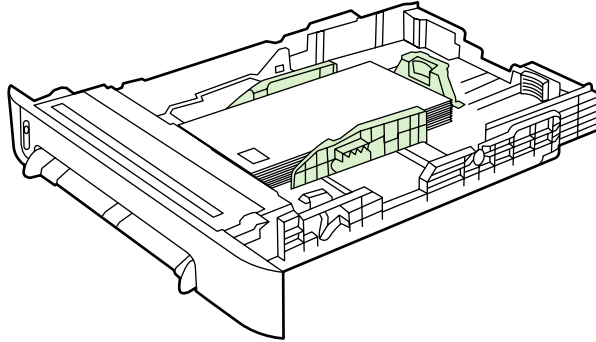

NOTE

If the envelope has a flap on a short edge, this edge must enter the printer first.

4. Slide the side-width guides inward until they lightly touch the stack without bending it. The stack should be centered between the guides and must be under the tabs on the guides.

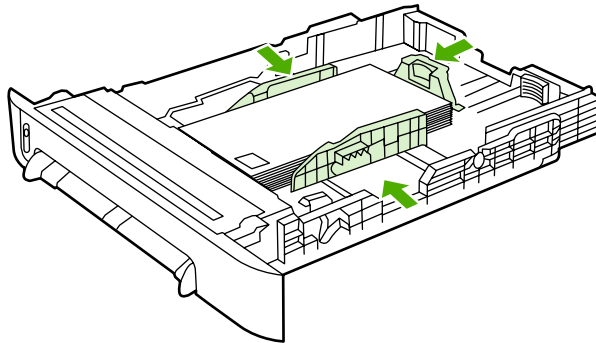

5. Select the envelope you are using as the Size (Windows) or the Paper (Macintosh) in the **Print** dialog box or the printer driver.

Printing on labels

Follow these guidelines for using labels. See [Print-media specifications](#) for more details.

CAUTION

To avoid damaging the printer, use only labels that are recommended for laser printers. Never print on the same sheet of labels more than once or print on a partial sheet of labels.

- Avoid labels that are separating from the backing sheet or are wrinkled or damaged in any way.
- Feed or place labels in the trays with the top, short edge in first and the side to be printed on facing down for Tray 1 and the side to be printed on facing up for Tray 2. For Tray 1, make sure that the media is inserted far enough into the printer for the paper feed mechanism to grab the media.

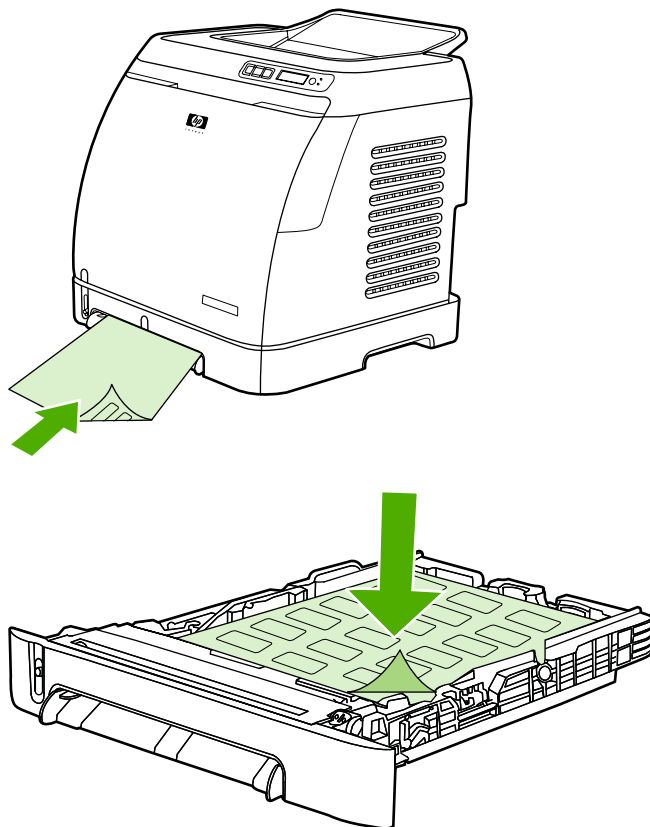

- Select **Labels** as the Type (Windows) or the Paper (Macintosh) from the **Print** dialog box or the printer driver.
- If a sheet of labels jams in the printer, see [Clearing jams](#).

Transparencies

When printing on transparencies, use the following guidelines:

CAUTION

To avoid damaging the printer, use only transparencies that are recommended for laser printers.

CAUTION

Transparent print media that is not designed for LaserJet printing will melt in the printer, and will damage the printer.

- Feed or place transparencies in the trays with the top, short edge in first and the side to be printed on facing down for Tray 1 and the side to be printed on facing up for Tray 2. For Tray 1, make sure that the media is inserted far enough into the printer for the paper feed mechanism to grab the media.

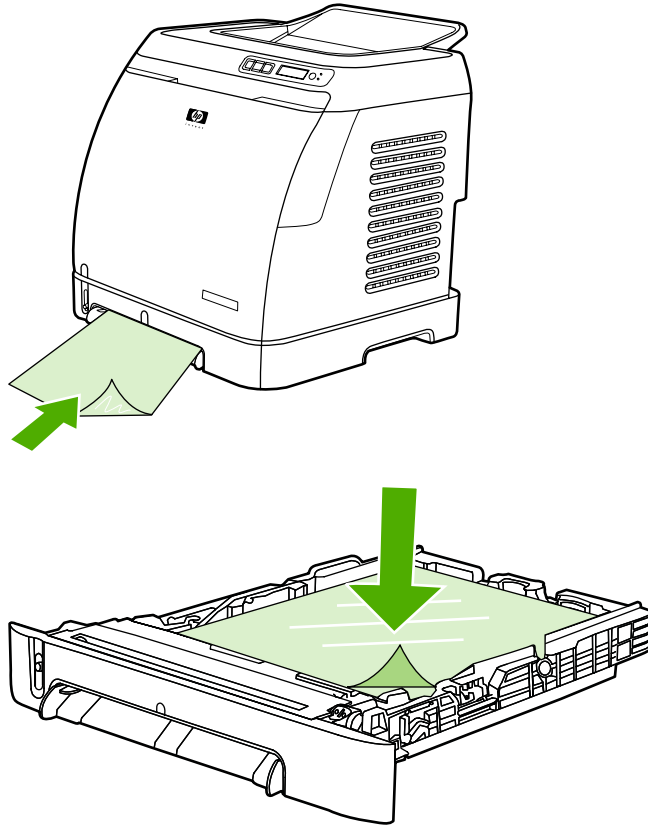

- Select **Transparencies** as the Type (Windows) or the Paper (Macintosh) in the **Print** dialog box or the printer driver.
- Place transparencies on a flat surface after removing them from the printer.

Printing on HP LaserJet glossy paper and HP LaserJet photo paper

This printer supports printing on HP LaserJet glossy paper and HP LaserJet photo paper. Follow these guidelines when printing on HP LaserJet glossy paper. See [Print-media specifications](#) for more information.

- Handle HP LaserJet glossy paper and HP LaserJet photo paper by the edges. Oil from your fingers that is deposited on HP LaserJet glossy paper and HP LaserJet photo paper can cause print-quality problems.
- Use HP LaserJet glossy paper and HP LaserJet photo paper only with this printer. HP products are designed to work together for optimum printing results.

- Feed or place HP LaserJet glossy paper and HP LaserJet photo paper in the trays with the top, short edge in first and the side to be printed on facing down for Tray 1 and the side to be printed on facing up for Tray 2.

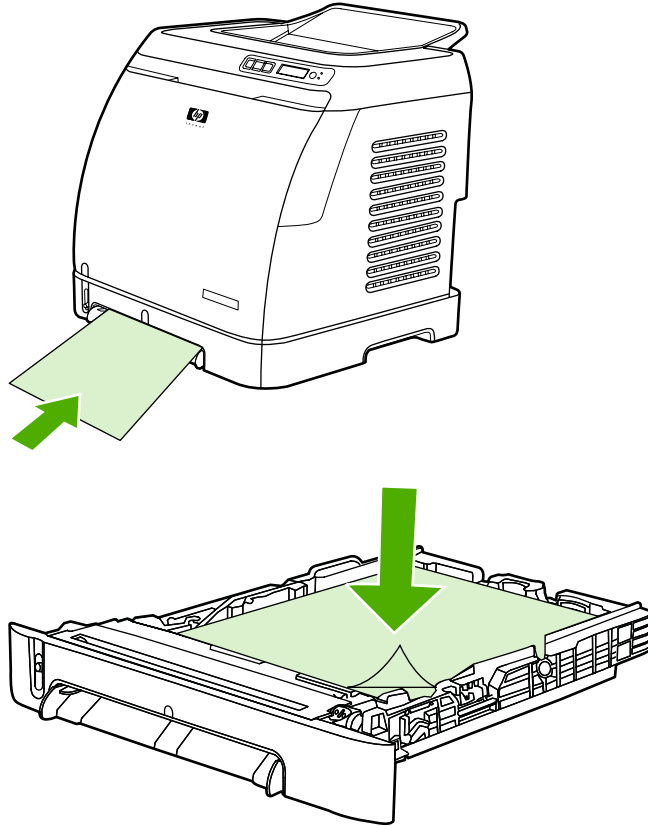

- Select **Light Glossy**, **Glossy** or **Heavy Glossy** as the Type (Windows) or the Paper (Macintosh) in the **Print** dialog box or the printer driver. Select **Light Glossy** for media weights of 105 g/m² (28 lb), **Glossy** for media weights of 120 g/m² (32 lb), and **Heavy Glossy** for media weights of 160 g/m² (43 lb).

Printing on letterhead or preprinted forms

This section shows how to orient letterhead or preprinted forms when you are printing only on one side.

- Tray 1: Feed paper with the top edge first and the side to be printed face down as shown in the following figure.
- Tray 2: Orient paper in with the side to be printed face up and the top edge toward the front of the printer as shown in the following figure.

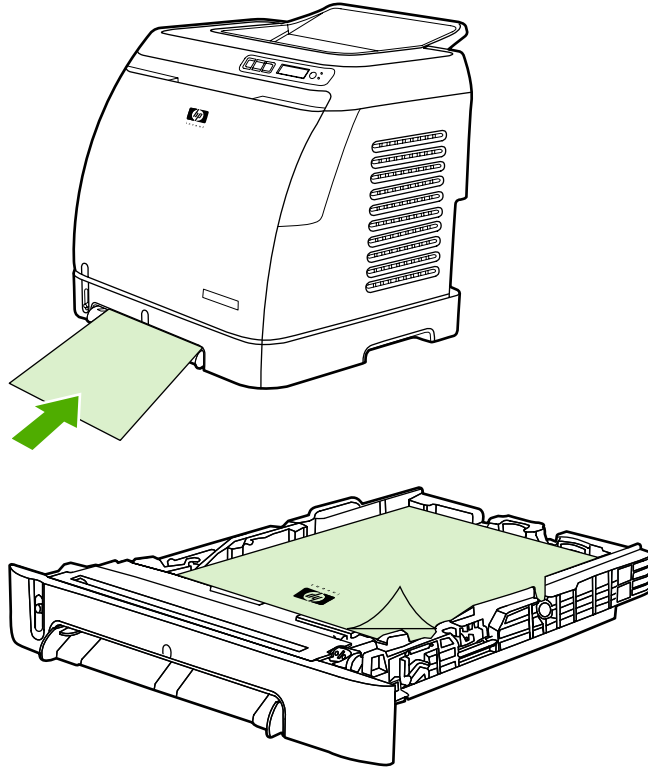

- Avoid using raised or embossed letterhead.
- Avoid using letterhead that is printed with low-temperature inks, such as those used in some types of thermography.
- The printer uses heat and pressure to fuse toner to the print media. Make sure that any colored paper or preprinted forms use inks that are compatible with this fusing temperature (210°C (410°F) for 0.1 second).

Printing on HP LaserJet Tough paper

When printing on HP LaserJet Tough paper, follow these guidelines:

- Handle HP LaserJet Tough paper by the edges. Oil from your fingers that is deposited on HP LaserJet Tough paper can cause print-quality problems.
- Use HP LaserJet Tough paper only with this printer. HP products are designed to work together for optimum printing results.
- In either the software program or the printer driver, select **Tough Paper** as the media type, or print from a tray that is configured for HP LaserJet Tough paper.

For loading information, see [Printing on letterhead or preprinted forms](#).

Printing on custom-sized print media or cardstock

Postcards, 3-x-5-inch (index) cards, and other custom-sized print media can be printed on from Tray 1 or Tray 2. The minimum size is 76 x 127 mm (3 x 5 inches) and the maximum size is 216 x 356 mm (8.5 x 14 inches).

- Always insert the short edge first into Tray 1 or Tray 2. To print in landscape mode, make this selection through your program. Inserting the media long-edge-first might cause a jam.
- In your program, set margins at least 6.4 mm (0.25 inch) away from the edges of the print media.
- Select the custom media that you are using as the **Type** in the printer driver and set the correct **Size**.

For instructions on loading media in Tray 1, see [To load Tray 1](#).

For instructions on loading media in Tray 2 or optional Tray 3, see [To load Tray 2 or optional Tray 3](#).

See [Print-media specifications](#) for more information.

Controlling print jobs

This section provides basic printing instructions. When making changes to printing settings, follow the hierarchy of how changes are prioritized. (Note that the names of commands and dialog boxes might vary depending on your software program.)

- **Page Setup dialog box.** This dialog box opens when you click **Page Setup** or a similar command on the **File** menu in your software program. This dialog box is part of the program in which you are working. *Settings that are changed here override settings that are changed anywhere else.*
- **Print dialog box.** This dialog box opens when you click **Print**, **Print Setup**, or a similar command on the **File** menu in your software program. It is also part of the program, but it has a lower priority than the **Page Setup** dialog box. Settings that are changed in the **Print** dialog box *do not* override settings that are changed in the **Page Setup** dialog box. Settings that are changed here *do* override settings that are changed in the printer driver.
- **Printer driver.** The printer driver opens when you click **Properties** in the **Print** dialog box. Settings that are changed here *do not* override settings that are changed anywhere else. (For Macintosh, the printer driver settings are integrated into the **Print** dialog box.)

Printing by tray Source versus by paper Type or paper Size

Three settings affect how the printer driver tries to pull media when you send a print job. These settings, **Source**, **Type**, and **Size**, appear in your program **Page Setup** dialog box, the **Print** dialog box, or the printer driver. The printer automatically selects a tray if you do not change these settings. If you do want to change these settings, you can print by **Source**, by **Type**, by **Size**, or by **Type** and **Size**. (For Macintosh OS X, types and sizes are both available from the **Paper** pop-up menu.)

- **Source.** Printing by **Source** means that you select a specific tray from which you want the printer to pull paper. The printer tries to print from this tray, no matter what type or size is loaded in it. However, if you select a tray that is configured from the HP Toolbox for a type or size and that does not match your print job, the printer does not print automatically. Instead, it waits for you to load the tray that you selected with the type or size of print media for your print job. When you load the tray, the printer begins printing. (If it does not begin, you might need to configure the tray to match the size or type of the print job.) Or, press (**SELECT**) to have the printer try to print from another tray.
- **Type or Size.** Printing by **Type** or **Size** means that you want the printer to pull paper or print media from the first tray that is loaded with the type or size that you selected. *Always print by Type for special print media such as labels or transparencies.*
 - If you want to print by **Type** or **Size** and the trays have not been configured for a certain type or size from the HP Toolbox, load the paper or print media into a tray and then select the **Type** or **Size** from the **Page Setup** dialog box, the **Print** dialog box, or the printer driver.
 - If you often print on a certain type or size of media, the printer administrator (for a network printer) or you (for a directly connected printer) can use the HP Toolbox to configure a tray for that type or size. (See [HP Toolbox](#).) Then, when you select that Type or Size as you print a job, the printer pulls from the tray that is configured for that type or size.

Features in the printer driver

Some printer drivers and some operating systems do not support all of these printer features.

- Setting a custom paper size
- Printing in grayscale
- Changing the color settings
- Creating and using watermarks
- Printing multiple pages on one sheet of paper (N-up printing)
- Creating and using Quick Sets
- Reducing or enlarging
- Printing on different paper for the first page
- Changing the print quality
- Restoring the default printer-driver settings

For printing using the Print on Both Sides (manually) feature, see [Printing on both sides](#).

Setting a custom paper size

Use the Custom Paper feature to set up the printer to print to sizes other than standard ones.

- Windows: Try to set this setting from *one* of these locations, in this order: the **Page Setup** dialog box in the program, the **Print** dialog box in the program, or the **Paper** tab in the printer driver.
- Mac: To set a custom paper size, click **File**, and then click **Page Setup**. Click the **Settings** menu, and select **Custom Paper Size**. (Mac OS X v10.2 does not support custom paper-size settings.)

Printing in grayscale

If you have a document that you created in color, it will automatically print in color. Or, you can set the printer to print a color document in grayscale (black and white) only.

- Windows: Select the **Print In Grayscale** option on the **Color** tab of the printer driver.
- Mac: In the **Print** dialog box, select the **Color Options** tab, and then select the **Print Color as Gray** checkbox.

Changing the color settings

When you are printing in color, the printer driver automatically sets the optimal color settings for you. However, you can manually make adjustments to how the printer prints in color for text, graphics, and photographs. See [Printing on special media](#) for more information.

- Windows: On the **Color** tab of the printer driver, click **Settings**.
- Mac: In the Print dialog box, click the **Color Options** tab, and then the **Show Advanced Options** button.

Creating and using watermarks

Use the Watermark options to specify that text be placed "underneath" (in the background of) an existing document. For example, you might want to have large gray letters reading "draft" or "confidential" placed diagonally across the first page or all pages of a document. You can change color, position, and wording of the watermark.

NOTE

If you are using Windows 2000 or XP, you must have Administrator privileges to create watermarks. You do not need Administrator privileges to add existing watermarks to documents.

- Windows: Gain access to the **Watermark** options on the **Effects** tab in your printer driver.
- Mac: Gain access to the Watermark options on the watermark/overlay pull-down menu in the **Print** dialog box. (Note that OS X might not support Watermarks.)

Printing multiple pages on one sheet of paper (N-up printing)

N-up printing is the ability to print multiple pages on one sheet of paper. The pages will appear decreased in size. You can specify up to nine pages per sheet, and they will be arranged on the sheet as shown in the following figures if you use the default arrangement. You can also choose whether a border appears around each page or not.

- Windows: Gain access to **Pages per Sheet** on the **Finishing** tab in the printer driver.
- Mac: Gain access to **Pages per sheet** by selecting the **Layout** pop-up menu in the **Print** dialog box.

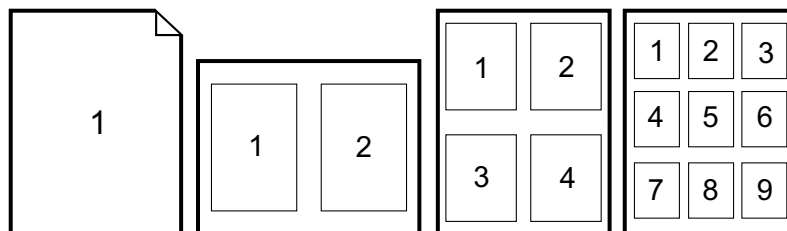

Creating and using Quick Sets

Use Quick Sets to save the current print-driver settings such as the page orientation, N-up printing, or the paper source for later use. You can save up to a total of 30 sets of settings. For convenience, Quick Sets can be selected and saved from most printer-driver tabs.

NOTE

If you are using Windows 2000, you must have Administrator privileges to save Quick Sets.

- Windows: Create Quick Sets from most printer-driver tabs. Later, you can gain access to Quick Sets on the **Finishing** tab in the printer driver.
- Mac: This feature is not supported.

Reducing or enlarging

Use the **Fit to Page** option to scale your document to a percentage of its normal size. You can also choose to scale your document to fit on any size of paper that the printer supports.

- Windows: Gain access to **Fit to Page** settings on the **Effects** tab in the printer driver.
- Mac: Gain access to Reduce and Enlarge (**Scale**) settings in the **Page Setup** dialog box.

Printing on different paper for the first page

Printing on different paper for the first page is useful if, for example, you are printing a letter that uses letterhead on the first page and plain sheets for the subsequent pages. The size for all pages of the print job must be the same in the printer driver.

- Windows: Try to set this setting from *one* of these locations, in this order: the **Page Setup** dialog box in the program, the **Print** dialog box in the program, or the **Paper/Quality** tab in the printer driver.
- Mac: On the **Paper Feed** pop-up menu in the **Print** dialog box, select the **First Page from** option. Then, select the source for the first page.

Restoring the default printer-driver settings

You can return all settings in the printer driver to their default values. This feature might be useful if you are experiencing quality issues, or if the print media is not being selected from the correct tray.

- Windows: Select **Defaults** in the **Quick Sets** dialog box on the **Finishing** tab of the printer driver.
- Mac: The Standard option contains the default settings and is automatically selected each time you open a program.

To print from Windows

1. Make sure that print media is loaded in the printer.
2. On the **File** menu, click **Page Setup** or a similar command. Make sure that the settings are correct for this document.
3. From the **File** menu, click **Print**, **Print Setup**, or a similar command. The **Print** dialog box opens.
4. Select this printer and change settings as necessary. Do not change any settings, such as page size or orientation, that you set in the **Page Setup** dialog box.
5. If this print job is for a standard size and weight of paper, you probably do not need to change the **Source is** (tray), **Type is**, or **Size is** settings, and you can go to step 7. Otherwise, go to step 6.
6. If this print job is to be printed on a non-standard size or weight of paper, select how the printer pulls paper.
 - To print by Source (tray), select the tray in the **Print** dialog box, if possible.
 - To print by Source (tray) when this setting is not available in the **Print** dialog box, click **Properties**, and on the **Paper** tab, select the tray in the **Source is** field.
 - To print by Type or Size, click **Properties** and, on the **Paper** tab, select the type or size in the **Type is** or **Size is** field. (For some paper, such as letterhead, you will set both the Type and Size.) *Always print by Type for special print media such as labels or transparencies.*
7. If you have not yet done so, click **Properties**. The printer driver opens.
8. On the various tabs, set any settings that you want that did not appear in the **Page Setup** or **Print** dialog box. For more information about printer-driver settings, see [Features in the printer driver](#).
9. Select the **Print** command to print the job.

To print from the Macintosh OS

1. Make sure that paper is loaded in the printer.
2. On the **File** menu, click **Page Setup**.
3. Make sure that this printer is selected on the **Format for** pop-up menu.
4. Select the size of paper onto which you are printing.
5. Select the **Orientation** and **Scale**, if necessary, and click **OK**.
6. On the **File** menu, click **Print**.
7. Use the following method to select the Source (tray) from which you want to print or select the Type of media onto which you want to print. *Always print by Type for special print media such as labels or transparencies.*
 - Mac: On the **Paper Feed** pop-up menu, select the tray or type of media.
8. Set any other settings that you want, such as watermarks. (For more information, see [Gaining access to printer driver settings.](#))
9. Select the **Print** command to print the job.

Gaining access to printer driver settings

This section lists the common printing features that are controlled through the printer driver. (The printer driver is the software component you use to send print jobs to the printer.) You can change settings temporarily for the print jobs that you print while the program is still open. You can also make permanent changes to the default settings, and those new settings will be in effect now and in the future.

Operating System	Temporarily change settings for jobs that are printed now	Permanently change default settings ¹	Change configuration settings (For example, to add an optional tray or to enable or disable a driver feature such as "Allow manual duplexing")
Windows 98 Second Edition and Me	On the File menu, click Print , select this printer, and then click Properties . (The actual steps can vary; this is the most common method.)	Click Start , point to Settings , and then click Printers . Right-click the printer icon, and then click Properties .	Click Start , point to Settings , and then click Printers . Right-click the printer icon, and then click Properties . Click the Configure tab.
Windows 2000 and XP (Classic Start Menu)	On the File menu, click Print , select this printer, and then click Properties or Preferences . (The actual steps can vary; this is the most common method.)	Click Start , point to Settings , and then click Printers or Printers and Faxes . Right-click the printer icon, and then click Printing Preferences .	Click Start , point to Settings , and then click Printers or Printers and Faxes . Right-click the printer icon, and then click Properties . Click the Configure tab.
Windows XP	On the File menu, click Print , select this printer, and then click Properties or Preferences . (The actual steps can vary; this is the most common method.)	Click Start , click Printers and Faxes , right-click the printer name or icon, and then click Printing Preferences .	Click Start and then click Printers and Faxes . Right-click the printer icon, and then click Properties . Click the Configure tab.

Operating System	Temporarily change settings for jobs that are printed now	Permanently change default settings ¹	Change configuration settings (For example, to add an optional tray or to enable or disable a driver feature such as "Allow manual duplexing")
Macintosh OS X v10.2 and later	On the File menu, click Print . Change settings as necessary on the various pop-up menus.	On the File menu, click Print . To change settings as necessary, use the various pop-up menus, and then on the Presets pop-up menu, click Save as and type a name for the preset. These settings are saved in the Presets menu. To use the new settings, you must select the saved preset option every time that you open a program and print.	Change configuration settings is not available for Mac.

¹ Access to default printer settings might be restricted and therefore unavailable.

Printing on both sides

To print on both sides of the paper, you have to return to the printer and reinsert the paper manually after the first side has printed.

CAUTION

Do not print on both sides of labels or transparencies. Damage to the printer and jams might result.

To print on both sides (manually)

1. Insert enough paper into Tray 2 or optional Tray 3 to accommodate the print job.

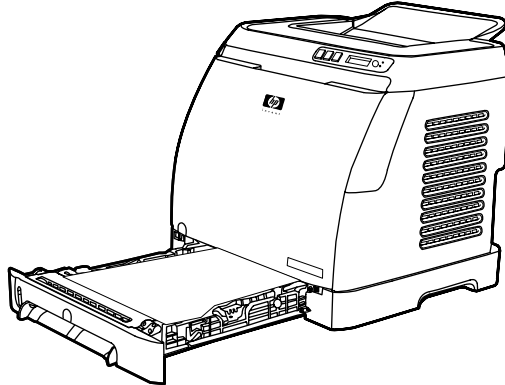

NOTE

In Windows, **Print on both sides (manually)** must be enabled to complete these instructions. To enable duplexing, in the printer driver, select **Properties**, and then click on the **Configure** tab. Under Paper handling, select **Allow Manual Duplexing**, and then click **OK** to save.

2. Use one of the following procedures to configure the printer to Print on both sides (manually).
 - Windows: In the printer driver, select the **Finishing** tab, select the **Print on both sides (manually)** option, and then send the job to print.
 - Mac: In the Mac Print window, in the **Copies & Pages** selection drop-down list, select **Manual Duplex**. On the next menu, select **Print on both sides (manually)** and then send the job to the printer.

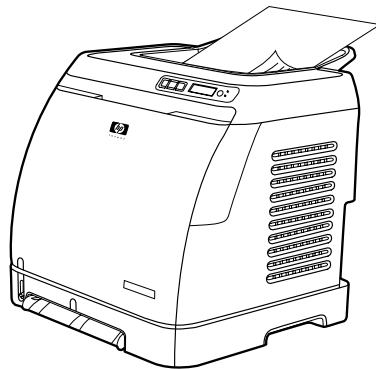



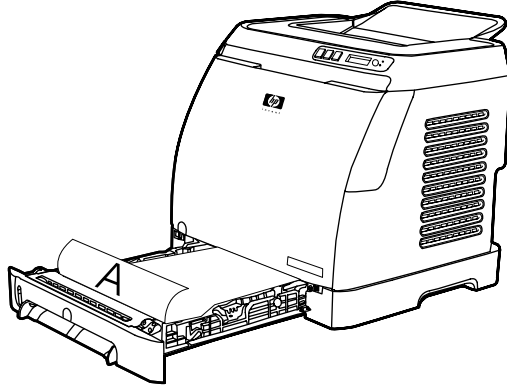

3. After the job is finished printing, remove any blank paper from Tray 2 or optional Tray 3. Lift the printed stack from the output bin and insert the printed stack without rotating or turning the stack over into the printer tray that was used for the first part of the job.



4. Press  (SELECT) to continue printing on the second side.

Canceling a print job

A print job can be canceled from a program, from a print queue, or from the  (CANCEL JOB) button on the printer.

- If the printer has not started printing, first try to cancel the job within the program that sent the print job.
- If the print job is waiting in a print queue or print spooler such as the **Printers** folder in Windows (**Printers or faxes** in Windows 2000 or Windows XP) or **Print Center Queue** in Mac, try to delete the job from there next.
- If the print job is already printing, press  (CANCEL JOB) on the printer. The printer finishes printing any pages that are already moving through the printer and deletes the remainder of the print job.
- Pressing  (CANCEL JOB) cancels only the current job in the printer. If more than one print job is in printer memory, you must press  (CANCEL JOB) once for each job after the job starts printing.

If the Printer Status lights continue to cycle after a job has been canceled, the computer is still sending the job to the printer. Either delete the job from the print queue or wait until the computer finishes sending data.

5

Color

This chapter describes how the printer provides great color printing. This chapter also describes ways to produce the best possible color prints. The following topics are covered:

- [Using color](#)
- [Managing color options](#)
- [Matching colors](#)

Using color

This printer offers great color as soon as you set it up. It provides a combination of automatic color features to generate excellent color results for the general user, plus sophisticated tools for the experienced color user.

The printer provides carefully designed and tested color tables to provide smooth, accurate color rendition of all printable colors.

HP provides free online tools to help businesses of all sizes with their color printing. HP's Office Color Printing Center (<http://www.hp.com/go/color>) identifies solutions and information on creating finished projects.

HP ImageREt 2400

ImageREt 2400 provides 2400 dots-per-inch (dpi) color laser-class quality through a multi-level printing process. This process precisely controls color by combining up to four colors within a single dot and by varying the amount of toner in a given area. ImageREt 2400 has been improved for this printer. The improvements offer trapping technologies, greater control over dot placement, and more precise control of toner quality in a dot. These new technologies, coupled with HP's multi-level printing process, result in a 600 x 600 dpi printer that provides 2400-dpi color laser-class quality with millions of smooth colors.

In contrast, the single-level printing process found in the default mode of other color laser printers does not allow the colors to be mixed within a single dot. This process, called dithering, significantly hinders the ability to create a wide range of colors without reduced sharpness or visible dot structure.

Media selection

For the best color and image quality, it is important to select the appropriate media type from the software printer menu or from the printer driver. See [Print-media specifications](#) for more information.

Color options

Color options enable optimal color output automatically for diverse types of documents.

Color options use object tagging, which allows optimal color settings to be used for different objects (text, graphics, and photos) on a page. The printer driver determines which objects are used on a page and uses color settings that provide the best print quality for each object. Object tagging, combined with optimized default settings, produces great color from the printer without having to establish any special settings.

In the Windows environment, the **Automatic** and **Manual** color options are on the **Color** tab in the printer driver.

Standard red-green-blue (sRGB)

Standard red-green-blue (sRGB) is a worldwide color standard that was originally developed by HP and Microsoft as a common color language for monitors, input devices (scanners and digital cameras), and output devices (printers and plotters). It is the default color space that is used for HP products, Microsoft operating systems, the World Wide Web, and most office software that is sold today. The sRGB standard is representative of the typical Windows computer monitor and is the convergence standard for high-definition television.

NOTE

Factors such as the type of monitor you use and the room's lighting can affect the appearance of colors on your screen. For more information, see [Matching colors](#).

The latest versions of Adobe® Photoshop®, CorelDRAW™, Microsoft Office, and many other applications use sRGB to communicate color. Most importantly, as the default color space in Microsoft operating systems, sRGB has gained broad adoption as a way to exchange color information between software programs and devices by using a common definition that assures that typical users will experience greatly improved color matching. The sRGB standard improves your ability to match colors between the printer, the computer monitor, and other input devices (scanners and digital cameras) automatically, without the need to become a color expert.

Managing color options

Setting color options to **Automatic** typically produces the best possible print quality for color documents. However, in some situations, you might want to print a color document in grayscale (black and shades of gray) or to change one of the printer's color options.

- Using Windows, print in grayscale or change the color options by using the settings on the **Color** tab in the printer driver.
- Using a Macintosh computer, print in grayscale or change the color options by using the **Color Options** pop-up menu in the **Print** dialog box.

Print in Grayscale

Selecting the **Print in Grayscale** option from the printer driver prints a document in black and shades of gray. This option is useful for printing color documents that will be photocopied or faxed.

When **Print in Grayscale** is selected, the printer goes into monochrome mode.

Automatic versus Manual color adjustment

The **Automatic** color adjustment option optimizes the neutral gray color treatment, and the edge enhancements that are used for each element in a document. For more information, see your printer-driver online Help.

NOTE

Automatic is the default setting and is recommended for printing all color documents.

Use the **Manual** color adjustment option to adjust the neutral gray color treatment, and the edge enhancements for text, graphics, and photographs. To gain access to the Manual color options, on the **Color** tab, click **Manual**, and then click **Settings**.

Manual color options

Use the Manual color adjustment to adjust the **Color** (or **Color Map**) options.

NOTE

Some software programs convert text or graphics to raster images. In these cases, the **Photographs** setting also controls the text and graphics.

Halftone options

Halftoning is the method by which the printer mixes the four primary colors (cyan, magenta, yellow, and black) in varying proportions to create millions of colors. Halftone options affect the resolution and clarity of your color output. The two halftone options are **Smooth** and **Detail**.

- The **Smooth** option provides better results for large, solid-filled print areas. It also enhances photos by smoothing out fine color gradations. Choose this option when uniform and smooth area fills are the most important attributes.
- The **Detail** option is useful for text and graphics that require sharp distinctions among lines or colors, or images that contain a pattern or a high level of detail. Choose this option when sharp edges and details are the most important attributes.

Edge Control

The **Edge Control** setting determines how edges are rendered. Edge Control consists of two components: Adaptive Halftoning and Trapping. Adaptive Halftoning increases the edge sharpness. Trapping reduces the effect of color-plane misregistration by slightly overlapping the edges of adjacent objects. The following levels of edge control are available:

- **Off** sets Trapping and Adaptive Halftoning to Off.
- **Normal** provides the default trapping settings. Adaptive Halftoning is set to On.
- **Maximum** provides the most trapping. Adaptive Halftoning is set to On.

RGB Color

The **RGB Color** option determines how colors are rendered.

- **Default** interprets RGB color as sRGB, which is the accepted standard for many software companies and organizations, such as Microsoft and the World Wide Web Consortium. (See <http://www.w3.org>.)
- **Device** sets the printer to print RGB data in raw device mode. To render photographs properly when this option is selected, you must manage color in the program in which you are working or in the operating system.
- **Vivid** instructs the printer to increase the color saturation in the midtones. Less colorful objects are rendered more colorfully. This value is recommended for printing business graphics.
- **Photo Image** interprets the RGB color as if it were printed as a photograph using a digital mini-lab. It is designed to render the deeper, more saturated colors differently than Default mode. Use this setting for printing photos.

Neutral Grays

The **Neutral Grays** setting determines the method for creating gray colors that are used in text, graphics, and photographs.

- **Black Only** generates neutral colors (grays and black) by using only black toner. This option guarantees that neutral colors do not have a color cast.
- **4-Color** generates neutral colors by combining all four colors of toner. This option produces smoother gradients and transitions to non-neutral colors. It also produces the darkest possible black.

Matching colors

The process of matching printer output color to your computer screen is quite complex because printers and computer monitors use different methods of producing color. Monitors display colors by light pixels using an RGB (red, green, blue) color process, but printers print colors using a CMYK (black, yellow, cyan, and magenta) process.

The following factors can influence your ability to match printed colors to those on your screen:

- Print media
- Printer colorants (inks or toners, for example)
- Printing process (inkjet, press, or laser technology, for example)
- Overhead lighting
- Programs
- Printer drivers
- Computer operating system
- Monitors
- Video cards and drivers
- Operating environment (very humid or very dry)
- Personal differences in perception of color

Keep these factors in mind if colors on your screen do not perfectly match your printed colors. For most users, the best method for matching colors on your screen to your printer is to print sRGB colors. The printer uses sRGB and automatically optimizes color output.

For more information about solving issues that are related to color output, see [Solving issues with color documents](#).

6

How do I?

Use this section to perform basic tasks with the HP Color LaserJet 2600n printer.

Print: How do I?

Use this section to answer printing questions.

Print on special media, such as glossy or photo paper

You can print on special media such as transparencies, labels, heavy paper, glossy paper, photo paper, and card stock, by using the optimizing feature in the printer driver.

1. Load the media input tray. Make sure that the top of the media is forward and the side to be printed on (the rough side of transparencies) is facing up.
2. Adjust the media guides to fit the width of the media.
3. Open a document in a program, such as Microsoft Word.
4. Select the print command. For most programs, click the **File** menu, and then click **Print**. The **Print** dialog box appears.
5. On the **Print** dialog box, click **Properties**.
6. On the **Paper** or **Quality** tab, select one of these media types:
 - **Plain**
 - **Preprinted**
 - **Letterhead**
 - **Transparency**
 - **Prepunched**
 - **Labels**
 - **Bond**
 - **Recycled**
 - **Color**
 - **HP Tough paper**
 - **Envelope**
 - **Light 60-74 g/m²**
 - **Heavy paper 91-105 g/m²**
 - **Cardstock 106-176 g/m²**
 - **Light Glossy 75-105 g/m²**
 - **Glossy 106-120 g/m²**
 - **Heavy Glossy 121-163 g/m²**
 - **HP Premium Cover 200 g/m²**
 - **HP Premium Plus Photo 220 g/m²**
7. Print the document. Remove the media from the device as it prints to prevent it from sticking together, and place the printed pages on a flat surface.

The media type can also be selected and configured in HP Toolbox. To configure these media types from HP Toolbox, click **Device Settings**, click the **System Settings** tab, and then open the **Print Modes** page. Make any necessary changes, and then click **Apply** to save the changes.

To print a single-page cover letter on letterhead, followed by a multiple-page document, load a single sheet of letterhead in Tray 1. After the letterhead page has printed, the device prompts you to load paper. Load paper for the rest of the document.

Print on both sides of the paper

To manually print on both sides of the paper, you must send the paper through the device twice.

CAUTION

Do not print on both sides of labels or transparencies.

1. Insert enough paper into Tray 2 or optional Tray 3 to accommodate the print job.
2. Use one of the following procedures to configure the printer to Print on both sides (manually).
 - Windows: In the printer driver, select the **Finishing** tab, select the **Print on both sides (manually)** option, and then send the job to print.
 - Mac: In the Mac Print window, in the **Copies & Pages** selection drop-down list, select **Manual Duplex**. On the next menu, select **Print on both sides (manually)** and then send the job to the printer.
3. After the job finishes printing, remove any blank paper from Tray 2 or optional Tray 3. Insert the printed stack, with the blank side up, and the top edge leading into the device. Print the second side from Tray 2 or optional Tray 3.

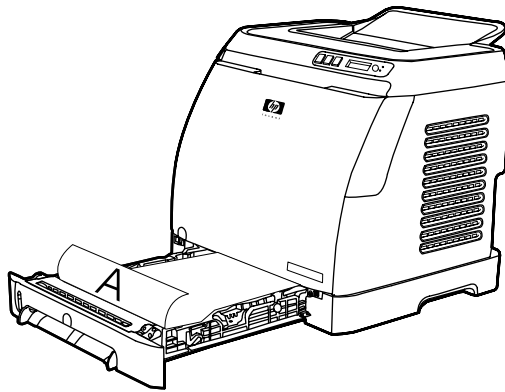

4. Press (SELECT) to continue printing.

Print on envelopes and custom media sizes

To print on envelopes, complete the following steps.

1. Set Tray 2 to the correct media size. See [Loading Tray 2 or optional Tray 3](#).
2. Load no more than 10 envelopes face-up with the flap of the envelope to the right, and the short edge feeding into the device first.
3. Use your computer software program to complete the printing process.

NOTE

For Tray 1, load one envelope at a time, face down and the flap to the right.

NOTE

Do not use envelopes with windows or clasps, and do not use envelopes that are wrinkled, nicked, curled, or otherwise damaged.

To print on custom media sizes, complete the following steps.

1. Load the media Tray 2 or optional Tray 3 with the narrow side forward and the side to be printed on facing up.
2. Adjust the side and rear media guides to fit the media.

3. At your computer, open a document in a program, such as Microsoft Word.
4. Select the print command. For most programs, click the **File** menu, and then click **Print**. The **Print** dialog box appears.
5. In the **Print** dialog box, click **Properties**.
6. On the **Paper** or **Quality** tab, select the correct media size.

NOTE

Software settings can override changes to the device properties.

7. Click **OK**.
8. Print the document.

Change the device print settings, such as print quality, in HP Toolbox

To change the default print settings in HP Toolbox, complete the following steps.

NOTE

The changes that you make to the print settings in HP Toolbox apply to all future print jobs.

1. Open HP Toolbox and click **Device Settings**.
2. Click the **Settings** tab.
3. On the **Settings** tab, you can modify settings that appear on the following pages.
 - **Paper Handling**
 - **Printing**
 - **Print Quality**
 - **Print Density**
 - **Paper type settings**
 - **Print Modes**
 - **System Setup**
 - **Service**
4. Click **Apply** to save the changes that you make on these pages.

NOTE

If you have similar settings in the printer driver, those settings take priority over the settings that are established in HP Toolbox.

Print color documents from my computer in black and white only

In the software program, select **File**, **Print**, the **HP Color LaserJet 2600n** print driver, click **Properties**, click the **Color** tab, and then select the **Print in Grayscale** check box. Click **OK** to save the print properties, and then click **OK** again to print the document.

Change color options

The Automatic color adjustment option optimizes the neutral gray color treatment, and the edge enhancements that are used for each element in a document. For more information, see your printer-driver online Help.

NOTE

Automatic is the default setting and is recommended for printing all color documents.

Use the Manual color adjustment option to adjust the neutral gray color treatment, and the edge enhancements for text, graphics, and photographs. To gain access to the Manual color options, on the Color tab, click **Manual**, and then click **Settings**. Use the Manual color adjustment to adjust the Color (or Color Map) options.

NOTE

Some software programs convert text or graphics to raster images. In these cases, the Photographs setting also controls the text and graphics.

Network: How do I?

Use this section to answer network questions.

Set up the device and use it on the network

Hewlett-Packard recommends that you use the HP software installer on the CD-ROMs that came with the device to set up printer drivers for the following network setups.

To change from a direct-connected shared device to a network port-connected device configuration

To change from a direct connection to a network configuration, complete the following steps.

1. Uninstall the printer driver for the direct connect device.
2. Install the driver as a network configuration by using the steps in [Networking](#).

Set my network password

Use HP Toolbox to set a network password.

1. Open HP Toolbox and click **Device Settings**.
2. Click the **Networking** tab.







NOTE

If a password has been set for the device previously, you will be prompted to type the password. Type the password, and then click **Apply**.

3. Click **Password**.
4. In the **Password** box, type the password you want to set, and then in the **Confirm password** box, type the same password again to confirm your choice.
5. Click **Apply** to save the password.

























Find my network IP address

The network IP address is located on the Configuration page. Use the following steps to print a Configuration page from the control panel.

1. Press  (LEFT ARROW) or  (RIGHT ARROW) to select the **Reports** menu.
2. Press  (SELECT).
3. Press  (LEFT ARROW) or  (RIGHT ARROW) to select **Config Report**.
4. Press  (SELECT) to print the Configuration Report page.

Configure a static IP address for my printer

Use the following steps to manually configure a static IP address from the control panel.

1. Press  (LEFT ARROW) or  (RIGHT ARROW) to select the **Network config** menu.
2. Press  (SELECT).
3. Press  (LEFT ARROW) or  (RIGHT ARROW) to select the **TCP/IP** menu.
4. Press  (SELECT).
5. Press  (LEFT ARROW) or  (RIGHT ARROW) to select **Manual**.
6. Press  (SELECT).
7. Press  (LEFT ARROW) or  (RIGHT ARROW) to enter the first three digits of the IP address.
8. Press  (SELECT) to save those digits and move to the next three digits of the IP address.
9. Press  (LEFT ARROW) or  (RIGHT ARROW) to enter the next three digits of the IP address.
10. Press  (SELECT) to save those digits and move to the next three digits of the IP address.
11. Press  (LEFT ARROW) or  (RIGHT ARROW) to enter the next three digits of the IP address.
12. Press  (SELECT) to save those digits and move to the next three digits of the IP address.
13. Press  (LEFT ARROW) or  (RIGHT ARROW) to enter the next three digits of the IP address.
14. Press  (SELECT).
15. The control panel will display **Yes**. Press  (SELECT) to save the configuration, or to delete and re-enter another IP address, press  (LEFT ARROW) or  (RIGHT ARROW), which will change the display to **No**.
16. After selecting the IP address, you will be prompted to enter the subnet mask and default gateway using steps 7-14 above.
17. If at any time during the configuration you press  (CANCEL JOB), the system will exit the menu and the addresses will not be saved.

Other: How do I?

Use this section to answer other questions about the device.

Changing print cartridges

When a print cartridge approaches the end of useful life, the control panel displays a message recommending that you order a replacement. The printer can continue to print using the current print cartridge until the control panel displays a message instructing you to replace the cartridge.

The printer uses four colors and has a different print cartridge for each color: black (K), cyan (C), magenta (M), and yellow (Y).

Replace a print cartridge when the printer control panel displays one of the following messages: **Replace yellow cartridge**, **Replace magenta cartridge**, **Replace cyan cartridge**, **Replace black cartridge**. The control panel display also indicates the color that should be replaced (unless a genuine HP cartridge is not currently installed).

To change the print cartridge

1. Open the front door.

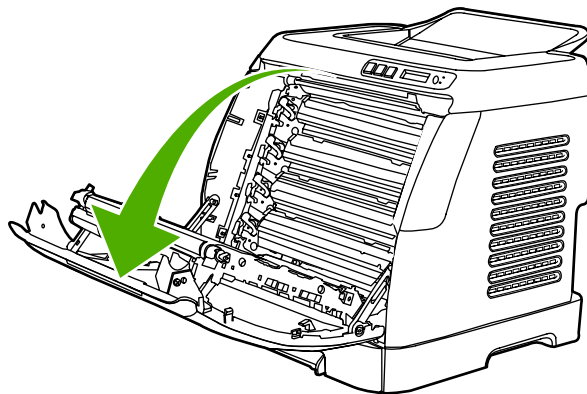

CAUTION

Do not place anything on the transfer belt (ETB), which is located on the inside of the front door.

2. Remove the used print cartridge from the printer.

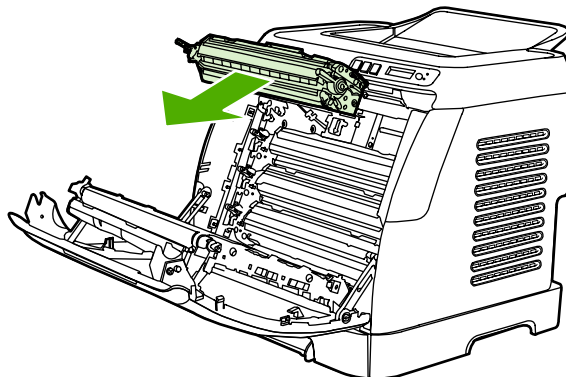

3. Remove the new print cartridge from the bag. Place the used print cartridge in the bag for recycling.

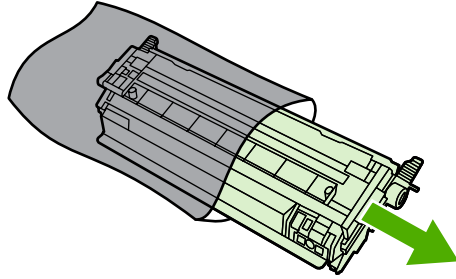

4. Grasp both sides of the print cartridge by the blue handles and distribute the toner by gently rocking the print cartridge from side to side.

CAUTION

Do not touch the shutter or the surface of the roller.

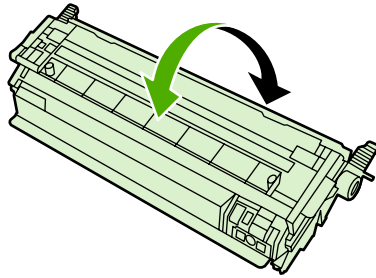

5. Remove the orange shipping locks and the orange shipping tape from the new print cartridge. Discard the shipping tape and shipping locks according to local regulations.

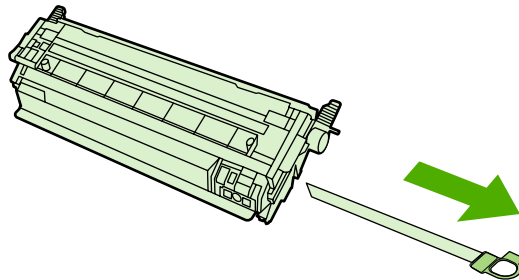

6. Align the print cartridge with the tracks inside the printer, and using the handles, insert the print cartridge until it is firmly seated.

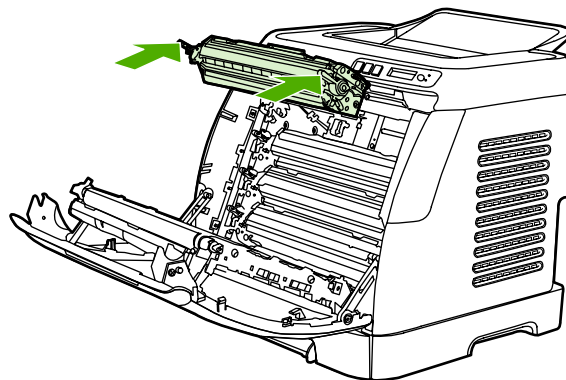

7. Firmly close the front door.

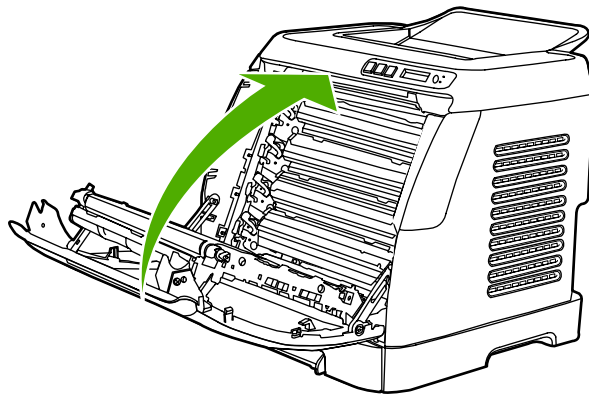

After a short time, the control panel should display **Ready**.

NOTE

If a cartridge is in the wrong slot or is the wrong type for the printer, the control panel will display one of the following messages: **Incorrect yellow**, **Incorrect magenta**, **Incorrect cyan**, **Incorrect black**.

8. Installation is complete. Place the used print cartridge in the box in which the new cartridge arrived. See the enclosed recycling guide for recycling instructions.
9. If you are using a non-HP print cartridge, check the printer control panel for further instructions.

For additional help, go to <http://www.hp.com/support/clj2600n>.

NOTE

When replacing or changing a black print cartridge, a cleaning page will automatically be printed. This helps prevent speckles on the front or back of printed documents. For a more thorough cleaning, see [To clean the fuser using HP Toolbox](#).

7

Managing the printer

This printer comes with several software tools that help you monitor, troubleshoot problems with, and maintain the printer. Information about using these tools is in the following sections:







- [Special pages](#)
- [Menu map](#)
- [HP Toolbox](#)
- [Using the embedded Web server](#)

3. **Paper Settings.** This section lists information about the media type for each tray and about the type settings for all the media that the printer supports.
4. **Page Counts.** This section lists the total number of pages printed, the number of color pages printed, and information about paper jams.
5. **Product Settings.** This section lists information that is gathered during software installation, including the language and the company name.
6. **Network Settings.** This section contains network information about the printer such as the Host Name, Hardware Address, and IP Address.
7. **Paper Types.** This section contains information about paper types that can be configured by the user.
8. **Status Log.** This section contains information about printer errors.

Supplies Status page

The Supplies Status page lists the remaining life of HP print cartridges. It also lists the estimated pages remaining, number of pages printed, and other supplies information. You can print a Supplies Status page from the printer or the HP Toolbox.

To print the Supplies Status page from the control panel

1. Press  (LEFT ARROW) or  (RIGHT ARROW) to select the **Reports** menu.
2. Press  (SELECT).
3. Press  (LEFT ARROW) or  (RIGHT ARROW) to select **Supplies Status**.
4. Press  (SELECT) to print the Supplies Status page.

NOTE

Supplies information is also available through the HP Toolbox.

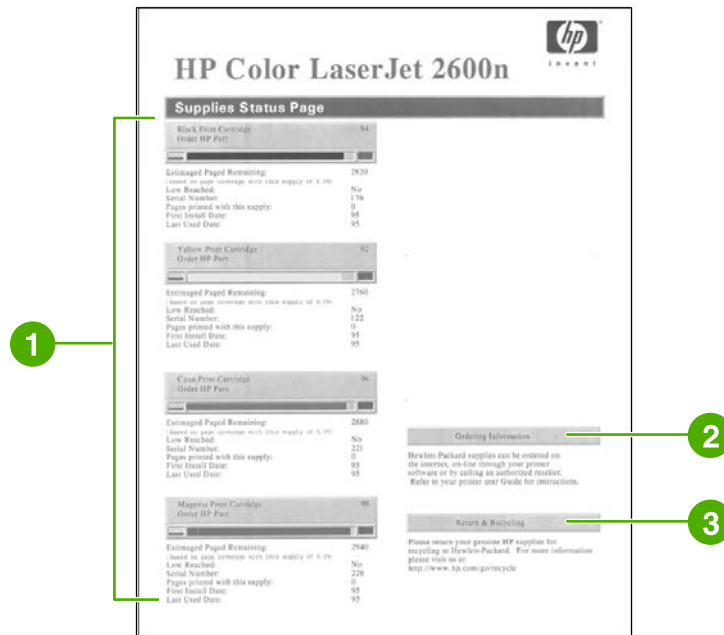







1. **Print cartridge area.** This area contains a section for each of the print cartridges and provides information about HP print cartridges. This information includes the part number for each print cartridge, whether each print cartridge is low, and the life remaining for each print cartridge, which is expressed as a percentage, as a graphic, and as the estimated number of pages remaining. This information might not be provided for non-HP supplies. In some cases, if a non-HP supply is installed, you will see an alert message instead.
2. **Ordering Information.** This section contains basic information about how to order new HP supplies.
3. **Return & Recycling.** This section contains a link to the website that you can visit for information about recycling.

Menu map

The menu map lists the menu structure for each option available on the printer control panel. Use the following steps to print a menu map.

To print a menu map

1. Press  (LEFT ARROW) or  (RIGHT ARROW) to select the **Reports** menu.
2. Press  (SELECT).
3. Press  (LEFT ARROW) or  (RIGHT ARROW) to select **Menu Structure**.
4. Press  (SELECT) to print the Menu map.

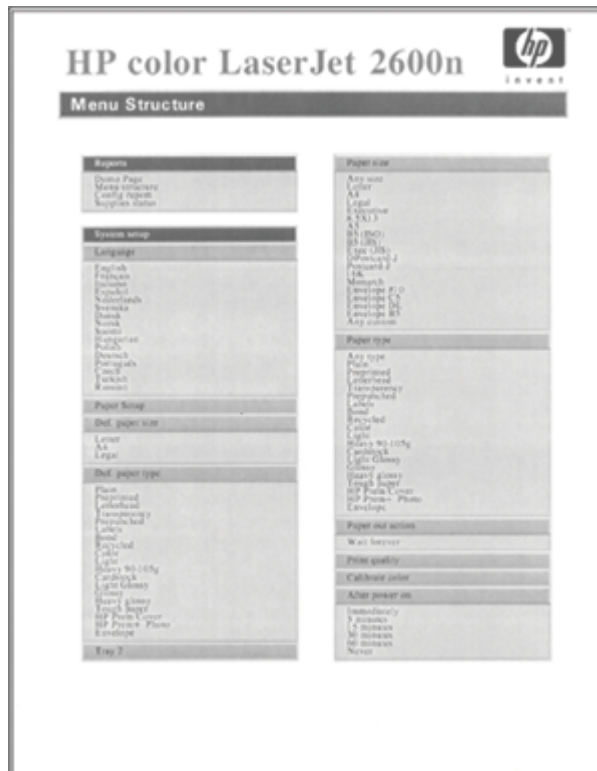

NOTE

The Menu map print as two pages.

HP Toolbox

The HP Toolbox is a Web application that you can use for the following tasks:

- Check the printer status.
- Configure the printer settings.
- View troubleshooting information.
- View online documentation.

You can view the HP Toolbox when the printer is directly connected to your computer or when it is connected to the network. You must perform a complete software installation to use the HP Toolbox.

NOTE

You do not need Internet access to open and use the HP Toolbox. However, if you click a link in the **Other Links** area, you must have Internet access to go to the site that is associated with the link. See [Other links](#) for more information.

Supported operating systems

The HP Toolbox is supported for the following operating systems:

- Windows 98 Second Edition
- Windows 2000
- Windows Me
- Windows XP

Supported browsers

To use the HP Toolbox, you must have one of the following browsers:

Windows

- Microsoft Internet Explorer 5.5 or later
- Netscape Navigator 6.2 or later
- Opera Software ASA Opera 7 or later

All pages can be printed from the browser.

To view the HP Toolbox

1. Open the HP Toolbox in one of these ways:
 - On the Windows desktop, double-click the HP Toolbox icon.
 - On the Windows **Start** menu, point to **Programs**, and click the **HP Toolbox**.

NOTE

After you open the URL, you can bookmark it so that you can return to it quickly in the future.

2. The HP Toolbox opens in a Web browser. The HP Toolbox software contains the following sections:
 - [Status tab](#)
 - [Troubleshooting tab](#)
 - [Alerts tab](#)
 - [Documentation tab](#)
 - [Device Settings](#)
 - [Other links](#)

Status tab

The **Status** tab has links to the following main pages:

- **Device Status.** View printer status information. This page indicates printer conditions such as a jam or an empty tray. After you correct a problem with the printer, click the **Refresh Status** button to update the device status.
- **Supplies Status.** View detailed supplies status such as the percent of toner remaining in the print cartridge and the number of pages that have been printed with the current print cartridge. This page also has links to order supplies and to find recycling information.
- **Print Info Pages.** Print the configuration page and various other information pages that are available for the printer, such as the supplies status page and the demo page.

Troubleshooting tab

The **Troubleshooting** tab has links to the following main pages:

- **Clearing Jams.** View information on locating and clearing jams, and view an animated demo of how to clear jams.
- **Print Problems.** View Help topics that can help you solve print problems.
- **Connectivity Problems.** View Help topics that can help you solve networking problems.
- **Troubleshooting Tools.** Print a page that assists in solving print-quality problems, view information about print-quality problems, print the cleaning page and clean the printer, and calibrate the printer to maintain color print quality.
- **Animated Demonstrations.** View animated Help demonstrations for the device.

Alerts tab

Use the **Alerts** tab to configure the printer to automatically notify you of printer status alerts.

Set up Status Alerts page

On the Set up Status Alerts page, you can choose to turn alerts on or off, and specify when the printer should send an alert.

Click **Apply** to activate the settings.

Documentation tab

The **Documentation** tab contains links to these information sources:

- **Print: How Do I?** View the How Do I? Help for print problems.
- **Network: How Do I?** View the How Do I? Help for network problems.
- **Other: How Do I?** View the How Do I? Help for other device problems.
- **User Guide.** Contains the information about the printer usage, warranty, specifications, and support that you are currently reading. The user guide is available in both HTML and PDF format.
- **Readme.** Contains important information about the printer that is not available in the user guide. The Late-Breaking Readme contains last-minute information about the printer (in English only).

Device Settings

The Device Settings button opens the embedded Web server using either a USB or network connection.

Other links

This section contains links that connect you to the Internet. You must have Internet access in order to use any of these links. If you use a dial-up connection and did not connect when you first opened the HP Toolbox, you must connect before you can visit these websites. Connecting might require that you close the HP Toolbox and reopen it.

- **HP Instant Support.**
- **Product Registration.** Connects to the HP product registration website.
- **Order Supplies.** Order device supplies at the HP website.
- **Product Support.** Connects to the support site for the HP Color LaserJet 2600n series printer where you can search for help with a specific problem.

Using the embedded Web server

When the printer is directly connected to a computer, use the HP Toolbox to view Web pages for the printer status.

When the printer is connected to the network, the embedded Web server is automatically available. You may access the embedded Web server from any supported browser.

The embedded Web server allows you to view printer and network status and to manage printing functions from your computer instead of using the printer control panel. Below are examples of what you can do using the embedded Web server:

- View printer status information.
- Set the type of paper loaded in each tray.
- Determine the remaining life on all supplies and order new ones.
- View and change tray configurations.
- View and change the printer.
- View and print internal information pages.
- View and change network configuration.

The embedded Web server supports the following browsers:

- Windows: Microsoft Internet Explorer 5.5 and later and Netscape Navigator 4 and later.
- Mac: Internet Explorer 5.1 and later, Netscape Navigator 7.01 and later, and Safari.

The embedded Web server works when the printer is connected to an IP-based network. The embedded Web server does not support IPX-based or AppleTalk printer connections. You do not need Internet access to open and use the embedded Web server.

To access the embedded Web server using a network connection

In a supported Web browser on your computer, type the IP address for the printer in the address/URL field. (To find the IP address, print a configuration page. For more information about printing a configuration page, see [Configuration page](#).)

NOTE

If you are unable to access the embedded Web server using the IP address, you can use the host name.

NOTE

Once you open the URL, you can bookmark it so that you can return to it quickly in the future.

1. The embedded Web server has three tabs that contain settings and information about the printer: the Information tab, the Settings tab, and the Networking tab. Click the tab that you want to view.
2. See the following sections for more information about each tab.

Information tab

The **Information** pages group consists of the following pages.

- **Device Status.** This page displays the printer status and shows the life remaining of HP supplies, with 0% indicating that a supply is empty. The page also shows the type and size of print media set for each tray.
- **Configuration.** This page displays the network and product information found on the printer Configuration page, such as page counts, print settings, and paper options.
- **Supplies Status.** This page displays the life remaining of HP supplies, with 0% indicating that a supply is empty. This page also provides supplies part numbers. To order new supplies, click **Order Supplies** in the **Other Links** area on the left side of the window. To visit any website, you must have Internet access.
- **Print Info Pages.** This page provides a remote way to print an internal page for a device.

Settings tab

This tab allows you to configure the printer from your computer. The **Settings** tab can be password protected. If this printer is networked, always consult with the printer administrator before changing settings on this tab.

The **Settings** tab contains the following pages.

- **Paper Handling.** Configure paper handling settings from this page.
- **Printing.** Configure the IO Timeout from this page.
- **Print Quality.** Use this page to configure color calibration and optimize settings.
- **Print Density.** Use this page to configure print density settings including contrast, highlights, midtones, and shadows.
- **Paper Type Settings.** Use this page to configure paper types
- **Print Modes.** Use this page to configure print mode settings.
- **System Setup.** Use this page to set up system settings, including jam recovery, auto continue, display contrast, and device language.
- **Service.** Use this page to start the cleaning mode and restore factory settings.

Networking tab

This tab allows the network administrator to control network-related settings for the printer when it is connected to an IP-based network.

- **IP Configuration.** Use this page to set the IP configuration.
- **Advanced.** Use this page to enable network features such as SLP Config, DHCP, BootP, and AutoIP.
- **mDNS.** Use this page to set the mDNS. Use these settings to turn on or off Rendezvous discovery.
- **SNMP.** Use this page to set SNMP protocols.
- **Password.** Use this page to set or change the Administrator Password.

Other links found in HP Toolbox

This section contains links that connect you to the Internet. You must have Internet access in order to use any of these links. If you use a dial-up connection and did not connect when you first opened the embedded Web server, you must connect before you can visit these websites. Connecting might require that you close the embedded Web server and reopen it.

- **HP Instant Support™.** Connects you to the HP website to help you find solutions. This service analyzes your printer error log and configuration information to provide diagnostic and support information specific to your printer.
- **Product Registration.** Click this link to connect to the HP website to register the product.
- **Order Supplies.** Click this link to connect to the HP website and order genuine HP supplies, such as print cartridges and paper.
- **Product Support.** Connects to the support site for the HP Color LaserJet 2600n printer where you can search for help regarding general topics.

8

Maintenance

This chapter contains information about these maintenance topics:

- [Managing supplies](#)
- [Cartridge out override](#)
- [Cleaning the printer](#)
- [Calibrating the printer](#)

Managing supplies

For warranty information about these supplies, see [Print Cartridge Limited Warranty Statement](#).

Supplies life

The life of a print cartridge depends on the amount of toner that print jobs require. When printing text at approximately 5% coverage, a cyan, magenta, or yellow print cartridge for the HP Color LaserJet 2600n printer lasts an average of 2,000 pages, and a black print cartridge lasts an average of 2,500 pages. A typical business letter has 5% coverage.

Checking and ordering supplies

You can check the supplies status by using the printer control panel, printing a Supplies Status page, or viewing the HP Toolbox, Hewlett-Packard recommends that you place an order for a replacement print cartridge when you first receive the Low message for a print cartridge. For typical use, the Order message indicates that approximately two weeks of life remains. When you use a new, authentic HP print cartridge, you can obtain the following types of supplies information:

- Amount of cartridge remaining
- Estimated number of pages remaining
- Number of pages printed
- Other supplies information

NOTE

If the printer is connected to the network, you can set the HP Toolbox to notify you by e-mail when a print cartridge is low or is near the end of its useful life. If the printer is directly connected to a computer, you can set HP Toolbox to notify you when supplies are low.

To check status and order using the control panel

Do one of the following:

- Check the supplies status gauges on the printer control panel. These gauges indicate when a print cartridge is low or empty. The lights also indicate when a non-HP print cartridge is first installed.
- To print the Supplies Status page from the printer, on the printer control panel, select **Reports Menu**, **Supplies Status**, and then **Print Supplies Status page**. See [Supplies Status page](#) for more information.

If the supplies levels are low, you can order supplies through your local HP dealer, by telephone, or online. See [Accessories and ordering information](#) for part numbers. See <http://www.hp.com/go/ljsupplies> to order online.

To check and order supplies using HP Toolbox

You can configure HP Toolbox to notify you when the supplies are low. You can choose to receive alerts by e-mail or as a pop-up message or taskbar icon. To order supplies by using the HP Toolbox, in the **Other Links** area, click **Order supplies**. You must have Internet access to connect to the website.

For more information, see [HP Toolbox](#).

Storing supplies

Follow these guidelines for storing print cartridges:

- Do not remove the print cartridge from its package until you are ready to use it.

CAUTION

To prevent damage, do not expose the print cartridge to light for more than a few minutes.

- See [Environmental specifications](#) for operating and storage temperature ranges.
- Store the supply in a horizontal position.
- Store the supply in a dark, dry location away from heat and magnetic sources.

Replacing and recycling supplies

To install a new HP print cartridge, follow the instructions that are included on the box that contains the new supply, or see the *Getting Started Guide*.

To recycle supplies, place the used supply in the box in which the new supply arrived. Use the enclosed return label to send the used supply to HP for recycling. For complete information, see the recycling guide that is included with each new HP supply item. See [HP LaserJet printing supplies](#) for more information about HP's recycling program.

HP policy on non-HP supplies

Hewlett-Packard Company cannot recommend the use of non-HP supplies, either new or remanufactured. Because they are not HP products, HP cannot influence their design or control their quality. Service or repairs required as a result of using a non-HP supply will *not* be covered under the printer warranty.

When you insert a supply into the printer, the printer will inform you if the supply is not a genuine HP supply. If you insert a genuine HP supply that has reached the low state from another HP printer, the printer identifies the supply as non-HP. Simply return the supply to the original printer to reactivate HP features and functionality.

Resetting the printer for non-HP supplies

When you install a non-HP print cartridge, the light next to the print cartridge you replaced blinks and the Attention light is on. In order to print with this supply, you must press  (SELECT) the first time you install this non-HP supply. The status gauges will not indicate when this type of supply is low or empty.

CAUTION

The printer will not stop printing when this type of supply is empty. Printer damage could occur if the printer prints with an empty print cartridge. See [Hewlett-Packard limited warranty statement](#) and [Print Cartridge Limited Warranty Statement](#).

HP anti-counterfeit website

Visit the HP anti-counterfeit website at <http://www.hp.com/go/anticounterfeit> if the supplies status gauges or HP Toolbox indicates that the print cartridge is not an HP print cartridge and you think that it is genuine.

Cartridge out override

What is it?

The HP Color LaserJet 2600n printer displays an **Order supplies** message when a cartridge is running low and a **Replace supplies** message when a cartridge has been depleted. **To ensure optimal print quality, HP recommends replacing a cartridge when the Replace supplies message is displayed.** Replacing the cartridge at this point can help prevent waste of media or other cartridges when one cartridge produces poor print quality.

The Cartridge Out Override feature allows the printer to continue using a cartridge that has reached the recommended replacement point.

WARNING!









Using Override may result in unsatisfactory print quality and unavailability of certain features (such as toner remaining information).

WARNING!

All print defects or supply failures incurred when an HP supply is used in Override will not be considered defects in materials or workmanship in the supply under HP's Print Cartridge Limited Warranty Statement. For Warranty information, see [Print Cartridge Limited Warranty Statement](#).

Configuration

Cartridge Out Override can only be enabled from the printer's control panel menu.

1. From the main menu, press  (RIGHT ARROW) to **System setup** and press  (SELECT).
2. Press  (RIGHT ARROW) to **Print quality** and press  (SELECT).
3. Press  (RIGHT ARROW) to **Replace supplies** and press  (SELECT).
4. Press  (RIGHT ARROW) to **Override out** and press  (SELECT).
5. Press  (SELECT).

If **Stop at out** is selected, the printer will stop printing when a cartridge reaches the recommended replacement point. If **Override out** is selected, the printer will continue printing when a cartridge reaches the recommended replacement point. The factory default setting is **Stop at out**.

On-going operation

Override can be enabled or disabled at any time, and does not have to be re-enabled for each cartridge. The printer will automatically continue printing when a cartridge reaches recommended replacement. The printer will display a message **Replace supply Override in use** while a cartridge is used in Override mode. When the cartridge is replaced with a new supply, Override will de-activate until another cartridge reaches recommended replacement.

Cleaning the printer

During the printing process, paper, toner and dust particles can accumulate inside the printer. Over time, this buildup can cause print-quality problems such as toner specks or smearing. This printer has a cleaning mode that can correct and prevent these types of problems.

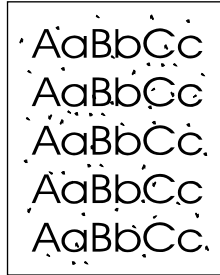

To clean the fuser using HP Toolbox

NOTE

Use the following procedure to clean the fuser using the HP Toolbox. To clean the engine when the computer is running an operating system that does not support HP Toolbox, see the late-breaking Readme on the root of the CD-ROM, or visit <http://www.hp.com/support/clj2600n>.

1. Make sure that the printer is turned on and in the Ready state.
2. Open the HP Toolbox.
3. On the **Troubleshooting** tab, click **Maintenance**, click **Cleaning Page** and then click **Print**. A page with a pattern prints from the printer.
4. At the printer, remove any print media in Tray 2 or optional Tray 3.
5. Remove the page that printed and load it face-down into Tray 2 or optional Tray 3.

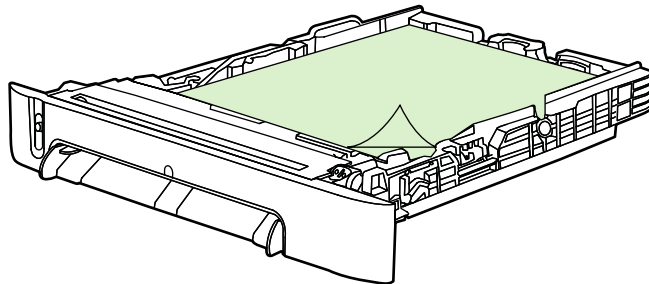

6. At the computer, press **Clean**.













Calibrating the printer

The printer automatically calibrates at various times. You can adjust the calibration settings by using the HP Toolbox.

Environmental differences or aging print cartridges might cause fluctuations in image density. The printer accounts for this with image stabilization control. The printer automatically calibrates at various times to maintain the highest level of print quality. You can also request a calibration by using the HP Toolbox.

The printer does not interrupt a print job to calibrate. It waits until the job is complete before calibrating or cleaning. While the printer is calibrating, it pauses printing for the time that is required to complete the calibration.

To calibrate the printer at the printer

1. To calibrate from the printer, press  (LEFT ARROW) or  (RIGHT ARROW) until the display reads **System setup**.
2. Press  (SELECT).
3. Press  (LEFT ARROW) or  (RIGHT ARROW) until the display reads **Print quality**.
4. Press  (SELECT).
5. Press  (LEFT ARROW) or  (RIGHT ARROW) until the display reads **Calibrate color**.
6. Press  (SELECT).
7. Press  (LEFT ARROW) or  (RIGHT ARROW) until the display reads **Calibrate now**.
8. Press  (SELECT).
9. Press  (SELECT) to confirm **Calibrate now**.

To calibrate the printer from the HP Toolbox

NOTE

This procedure applies to Windows operating systems only. Macintosh users should calibrate the printer manually using the procedure above.

1. Open the HP Toolbox in one of these ways:
 - On the desktop, double-click the **HP Toolbox** icon.
 - On the **Start** menu, point to **Programs**, point to **HP**, point to **HP Color LaserJet 2600n**, and click **HP Color LaserJet 2600n Toolbox**.
2. Click the **Troubleshooting** tab and then click **Troubleshooting Tools** (on the left side of the screen).
3. In the Calibration section, click **Calibrate now**.

9

Problem solving

This troubleshooting information is organized to help you resolve printing problems. Choose the general topic or type of problem from the following list.

- [Support strategy](#)
- [Troubleshooting process](#)
- [Control panel messages](#)
- [Clearing jams](#)
- [Print problems](#)
- [Troubleshooting tools](#)

Support strategy

This device has a one-year limited warranty. Warranty service and support options might vary depending on your country/region. Please refer to the support flyer that came in your box for contact information, or visit <http://www.hp.com>.

You can find additional support information in [Service and support](#).

Troubleshooting process

Use the troubleshooting checklist to solve issues with the device.

Troubleshooting checklist

Follow the steps below when trying to solve a problem with the device.

Step number	Verification step	Possible problems	Solutions
1	<p>Is the power on?</p> <p>When the device is connected to a grounded power source, the control panel shows Hewlett-Packard with both the Ready and Attention lights blinking. The control panel will then display Initializing and then Ready, at which time only the green light will be on.</p>	No power due to failed power source, cable, switch, or fuse.	<ol style="list-style-type: none"> 1. Verify that the device is plugged in. 2. Verify that the power cable is functional and that the power switch is on. 3. Check the power source by plugging the device directly into the wall or into a different outlet. 4. Test the outlet or connect another device to the outlet to verify that the outlet is functioning.
2	<p>Does Ready appear in the device control panel?</p> <p>The control panel should function without error messages.</p>	Control panel shows an error.	<p>See Control panel messages for a list of common messages that will help you correct the error.</p> <p>If the error persists, contact HP Customer Care. See HP Customer Care or the support flyer that came in the device box.</p>
3	<p>Do information pages print?</p> <p>Print a Configuration page.</p>	Control panel displays an error message.	See Control panel messages for a list of common messages that will help you correct the error.
		Media does not move smoothly through the device paper path.	Clean the paper path.
		Poor print quality.	<p>See Print quality problems.</p> <p>If the error persists, contact HP Customer Care. See HP Customer Care or the support flyer that came in the device box.</p>

Step number	Verification step	Possible problems	Solutions
4	<p>Does the device print from the computer?</p> <p>Connect the network cable or USB cable to the device and the computer. Use a word-processing application to send a print job to the device.</p>	Software is not installed correctly or an error occurred during software installation.	Uninstall and then reinstall the device software. Verify that you are using the correct installation procedure and the correct port setting.
		The cable is not connected correctly.	Reconnect the cable.
		An incorrect driver is selected.	Select the proper driver.
		Other devices are connected to the USB port.	Disconnect the other devices and try again to print.
		There is a port driver problem in Microsoft Windows.	Uninstall and then reinstall the device software. Verify that you are using the correct installation procedure and the correct port setting.
		If the error persists, contact HP Customer Care. See HP Customer Care or the support flyer that came in the device box.	

Control panel messages

The majority of the control-panel messages are intended to guide the user through typical operation. The control-panel messages indicate the status of the current operation, and include a page count on the second line of the display, if appropriate. When the device is print data, control-panel messages indicate this status. In addition, alert messages, warning messages, and critical error messages indicate situations that might require some action.



Alert and warning messages

Alert and warning messages appear temporarily and might require the user to acknowledge the message by pressing (SELECT) to resume or by pressing (CANCEL JOB) to cancel the job. With certain warnings, the job might not complete or the print quality might be affected. If the alert or warning message is related to printing and the auto-continue feature is on, the device will attempt to resume the printing job after the warning has appeared for 10 seconds without acknowledgement.

Alert and warning messages

Control panel message	Description	Recommended action
10.000x Supply error	E-label cannot be read or print cartridge is not properly installed.	<ol style="list-style-type: none"> 1. Reinstall print cartridge. 2. Power cycle device. 3. If the problem is not solved, replace the cartridge.
Device error Press <input type="checkbox"/>	An internal error occurred in the device.	Press <input type="checkbox"/> (SELECT) to resume the job.
Engine comm. error	The device experienced an internal communication error.	This is a warning message only. Job output might be affected.
Invalid driver	You are using the incorrect printer driver.	Reselect the printer driver appropriate for your device.
Invalid entry	Invalid data or response.	Correct the entry.
Jam in <> (<> indicates an area where the jam has occurred)	The device has detected a jam.	Clear the jam from the area indicated on the control panel. The job should continue to print. If it does not, try reprinting the job.
Memory is low Press <input type="checkbox"/>	The device memory has been almost completely filled.	<p>Allow the device to finish the job, or press <input type="checkbox"/> (SELECT) to cancel the job.</p> <p>Break the job into smaller jobs that contain fewer pages.</p>

Alert and warning messages (continued)

Control panel message	Description	Recommended action
No paper pickup Press [✓]	The print engine has failed to pick up a piece of media.	In Tray 1, verify that the media was inserted far enough into the tray. In Tray 2 or optional Tray 3, verify that the paper-length guide is in the correct position for the media size that you are using. Reload the media in the input tray and press  (SELECT) to continue the job. If the error persists, contact HP Customer Care. See HP Customer Care or the support flyer that came in the device box.
Replace supplies Override in use	A supply is low and using Override may result in unsatisfactory print quality.	Replace the supply that is low.
Settings cleared	The device has cleared job settings.	Re-enter any appropriate job settings.
Unauthorized yellow Unauthorized magenta Unauthorized cyan Unauthorized black	A new supply has been installed that is not made by HP. One of these four messages is displayed until an HP supply is installed or  (SELECT) is pressed.	If you believe you purchased an HP supply, please call the HP fraud hotline at 1-877-219-3183. Service or repairs required as a result of using non-HP supplies is not covered under HP warranty. To continue printing, press  (SELECT).

Critical error messages

Critical error messages can indicate some kind of failure. Cycling the power might fix the problem. If a critical error persists, the device might require service.

Critical error messages

Control panel message	Description	Recommended action
50 Fuser Error	The device has experienced an internal hardware error.	Turn off the device, wait at least 25 minutes, and then turn on the device. If a surge protector is being used, remove it. Plug the device directly into the wall socket. Use the power switch to turn on the device. If the error persists, contact HP Customer Care. See HP Customer Care or the support flyer that came in the device box.

Critical error messages (continued)

Control panel message	Description	Recommended action
51 Laser Error	The device has experienced an internal hardware error.	<p>Turn off the power by using the power switch, wait at least 30 seconds, and then turn on the power and wait for the device to initialize.</p> <p>If a surge protector is being used, remove it. Plug the device directly into the wall socket. Use the power switch to turn the device on.</p> <p>If the error persists, contact HP Customer Care. See HP Customer Care or the support flyer that came in the device box.</p>
52 Scanner Error	The device has experienced an internal hardware error.	<p>Turn off the power by using the power switch, wait at least 30 seconds, and then turn on the power and wait for the device to initialize.</p> <p>If a surge protector is being used, remove it. Plug the device directly into the wall socket. Use the power switch to turn the device on.</p> <p>If the error persists, contact HP Customer Care. See HP Customer Care or the support flyer that came in the device box.</p>
55.1 Error 59.A0 Error 54.1C Error	The device has experienced an internal hardware error.	<p>Turn off the power by using the power switch, wait at least 30 seconds, and then turn on the power and wait for the device to initialize.</p> <p>If a surge protector is being used, remove it. Plug the device directly into the wall socket. Use the power switch to turn the device on.</p> <p>If the error persists, contact HP Customer Care. See HP Customer Care or the support flyer that came in the device box.</p>
57 Fan Error Turn off then on	The device has experienced a problem with its internal fan.	<p>Turn off the power by using the power switch, wait at least 30 seconds, and then turn on the power and wait for the device to initialize.</p> <p>If the error persists, contact HP Customer Care. See HP Customer Care or the support flyer that came in the device box.</p>

Critical error messages (continued)

Control panel message	Description	Recommended action
79 Error Turn off then on	The device has experienced an internal firmware error.	Turn off the power by using the power switch, wait at least 30 seconds, and then turn on the power and wait for the device to initialize. If a surge protector is being used, remove it. Plug the device directly into the wall socket. Use the power switch to turn the device on. If the error persists, contact HP Customer Care. See HP Customer Care or the support flyer that came in the device box.

Clearing jams

Occasionally, paper or other print media can become jammed during a print job. Some causes include the following events:

- The input trays are loaded improperly or overfilled.
- Tray 2 or optional Tray 3 is opened during a print job.
- Too many sheets accumulated in the output area or sheets blocked the output area.
- The print media that is being used does not meet HP specifications. See [Print-media specifications](#).
- The environment in which the print media was stored is too humid or too dry. See [Print-media specifications](#).

Where to look for jams

Jams can occur in these locations:

- Inside the printer. See [To clear jams from inside the printer](#).
- In input areas. See [To clear jams from Tray 2 or optional Tray 3](#).
- In the output area. See [To clear jams from the top bin](#).

Find and remove the jam by using the instructions on the following pages. If the location of the jam is not obvious, first look inside the printer.

Loose toner might remain in the printer after a jam. This problem should resolve itself after a few sheets have been printed.

Each section below corresponds to an area where a paper jam could occur. Use the following procedures to clear the jam. In all cases, grasp the jammed paper by both corners and pull slowly to remove the paper.

To clear jams from inside the printer

CAUTION

Jams in this area might result in loose toner on the page. If you get toner on your clothes or hands, wash them in cold water. (Hot water will set the toner into the fabric.)

1. Open the front door.

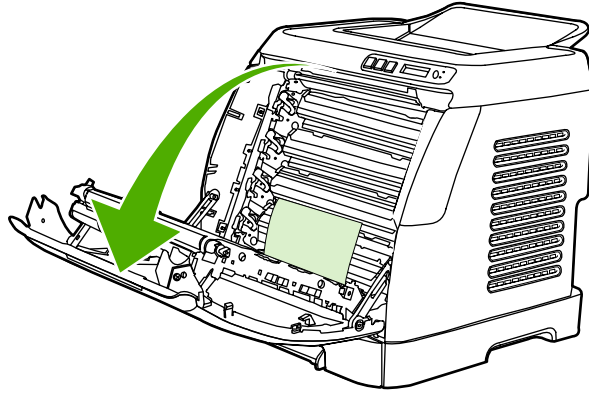

CAUTION

Do not place anything on the transfer belt, which is located on the inside of the front door. Otherwise, the printer may be damaged, adversely affecting print quality.

2. Carefully grasp the jammed paper by both corners and pull slowly to remove the paper.

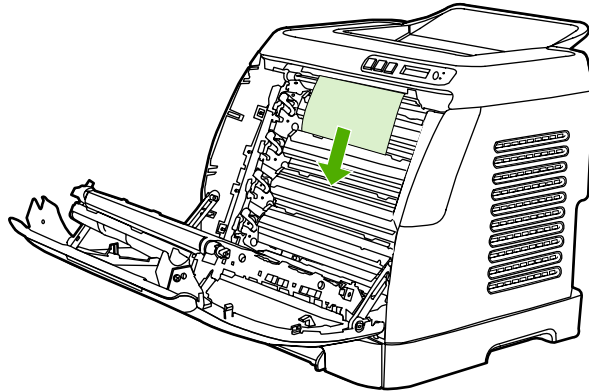
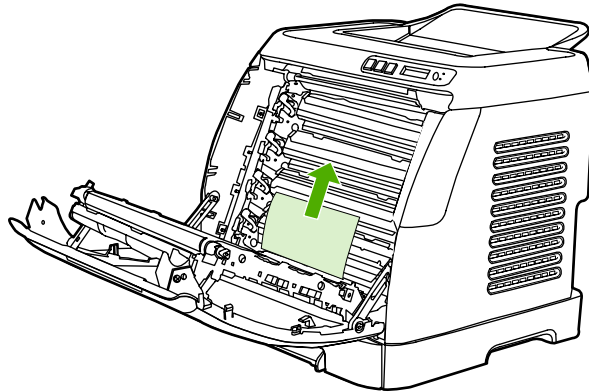

3. Close the front door.

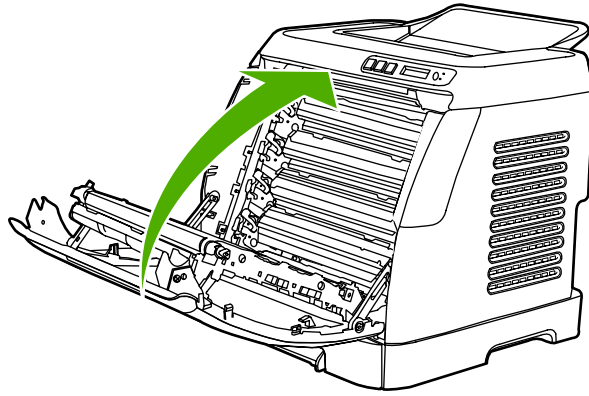

To clear jams from Tray 2 or optional Tray 3

NOTE

Before attempting to clear jams from Tray 2 or optional Tray 3, remove any jams inside the printer.

1. Pull Tray 2 or optional Tray 3 out of the printer.

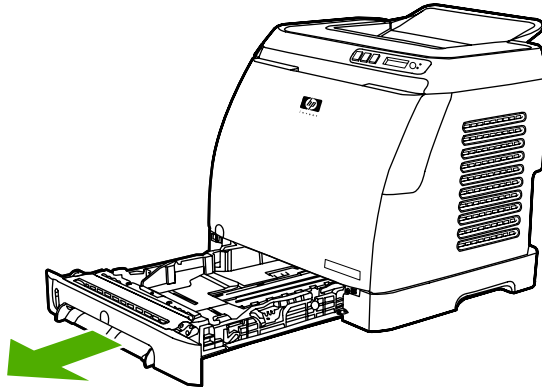

2. Carefully grasp the jammed paper by both corners and pull slowly to remove the paper.
3. Slide the tray into the printer.

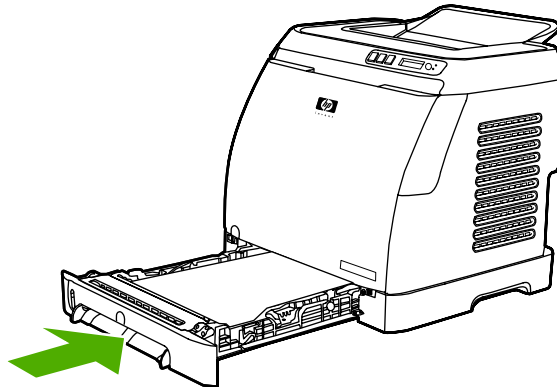

4. Open and close the front door.

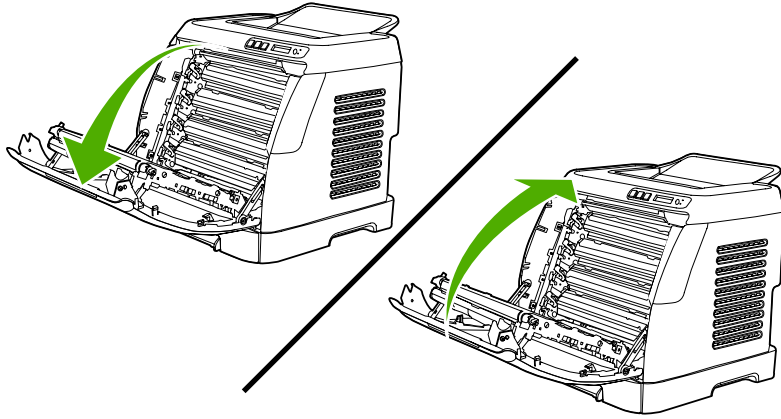

To clear jams from the top bin

CAUTION

Jams in these areas might result in loose toner on the page. If you get toner on your clothes or hands, wash them in cold water. (Hot water will set the toner into the fabric.)

1. Carefully grasp the jammed paper by both corners and pull slowly to remove the paper from the top bin.

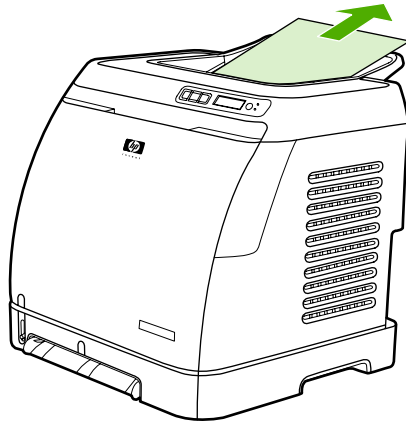

2. Open and close the front door.

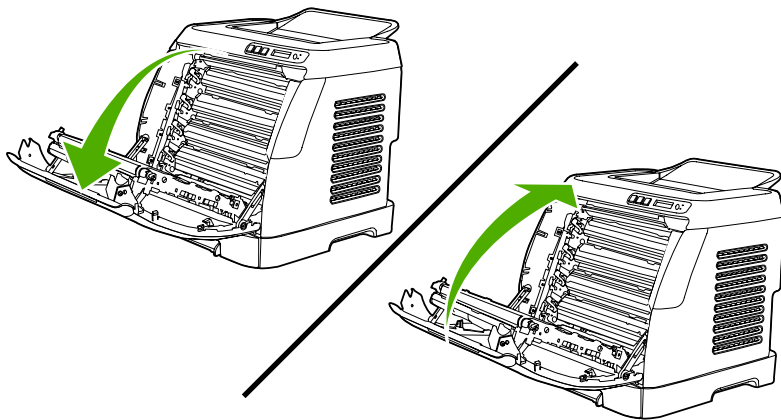

Print problems

Print quality problems

Occasionally, you might encounter problems with print quality. The information in the following sections helps you identify and resolve these issues.

Improving print quality

Use the print-quality settings to prevent print-quality problems.

Understanding print-quality settings

Print-quality settings affect how light or dark the print is on the page and the style in which the graphics are printed. You can also use the print-quality settings to optimize the print quality for a specific media type.

You can change the settings in the device properties to accommodate the types of jobs that you are printing. The following settings are available, depending on the printer driver that you are using:

- **600 dpi**
- **Custom:** This setting produces the same resolution as the default setting, but you can change the scale patterns.

NOTE

Changing the resolution can change the formatting of your text.

To temporarily change print-quality settings

To change the print-quality settings only for the current software program, open the properties through the **Print Setup** menu in the program that you are using to print.

To change print-quality settings for all future jobs

NOTE

For Macintosh instructions, see [Gaining access to printer driver settings](#) for more information.

For Windows 98, Windows 2000, and Windows Me:

1. In the Windows system tray, click **Start**, select **Settings**, and then click **Printers**.
2. Right-click the device icon.
3. Click **Properties** (in Windows 2000, you can also click **Printing Preferences**).
4. Change the settings, and click **OK**.

For Windows XP:

1. In the Windows system tray, click **Start**, click **Control Panel**, and then click **Printers and Faxes**.
2. Right-click the device icon.
3. Click **Properties**, or click **Printing Preferences**.
4. Change the settings, and click **OK**.

Identifying and correcting print defects

Use the checklist and print-quality issues charts in this section to solve print-quality problems.

Print-quality checklist



General print-quality problems can be solved by using the following checklist:

1. Make sure that the paper or print media that you are using meets specifications. Generally, smoother paper provides better results.
2. If you are using a special print media such as labels, transparencies, glossy, or letterhead, ensure that you have printed by type.
3. Print a Configuration page and Supplies Status page at the device. See [Special pages](#).
 - Check the Supplies Status page to see if any supplies are low or empty. No information is provided for non-HP print cartridges.
 - If the pages do not print correctly, the problem is with the hardware. Contact HP Customer Care. See [HP Customer Care](#) or the flyer that came in the device box.
4. Print a Demo page from the HP Toolbox. If the page prints, the problem is with the printer driver.
5. Try printing from a different program. If the page prints correctly, the problem is with the program from which you were printing.
6. Restart the computer and the device and try printing again. If the problem is not resolved, choose one of these options:
 - If the problem is affecting all printed pages, see [General print quality issues](#).
 - If the problem is affecting only pages printed in color, see [Solving issues with color documents](#).

General print quality issues

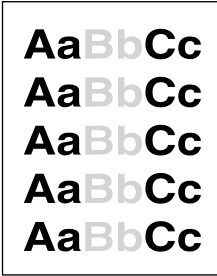

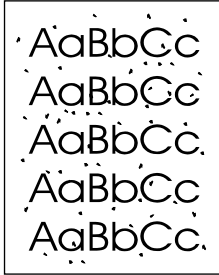
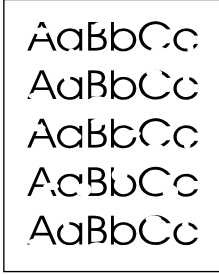
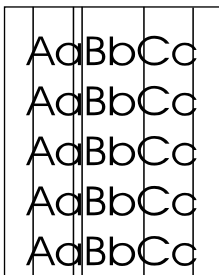
The following examples depict letter-size paper that has passed through the device short edge first. These examples illustrate problems that would affect all of the pages that you print, whether you print in color or in black only. The topics that follow list the typical cause and solution for each of these examples.

Problem	Cause	Solution
Print is light or faded. 	The media might not meet HP specifications.	Use media that meets HP specifications.
	One or more print cartridges might be low. If you are using non-HP print cartridges, no messages appear on the device control panel or in the HP Toolbox.	Replace any low print cartridges. See Changing print cartridges . If none of the print cartridges is low or empty, remove the print cartridges one at a time and inspect the toner roller in each to see if the roller is damaged. If so, replace the print cartridge.
		Print the Supplies Status page to check the remaining life. See Supplies Status page .

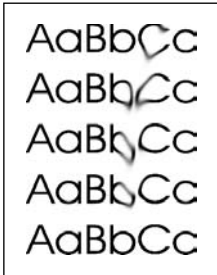
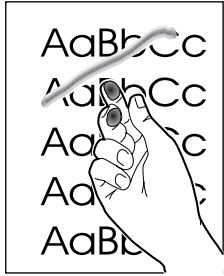
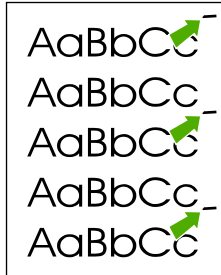
Problem	Cause	Solution
<p>Toner specks appear.</p> 	The media might not meet HP specifications.	Use media that meets HP specifications.
	The paper path might need cleaning.	Clean the paper path. See the HP Toolbox online Help.
<p>Dropouts appear.</p> 	A single sheet of print media might be defective.	Try reprinting the job.
	The moisture content of the paper is uneven or the paper has moist spots on its surface.	Try different paper, such as high-quality paper that is intended for color laser printers.
	The paper lot is flawed. The manufacturing processes can cause some areas to reject toner.	Try different paper, such as high-quality paper that is intended for color laser printers.
<p>Vertical streaks or bands appear on the page.</p> 	One or more print cartridges might be low or defective. If you are using non-HP print cartridges, no messages appear on the device control panel or in the HP Toolbox.	Replace any low print cartridges.
<p>The amount of background toner shading becomes unacceptable.</p> 	The media might not meet HP specifications.	Use a different paper with a lighter basis weight.
	Very dry (low humidity) conditions can increase the amount of background shading.	Check the device environment.
	One or more print cartridges might be low. If you are using non-HP print cartridges, no messages appear on the device control panel or in the HP Toolbox.	Replace any low print cartridges.

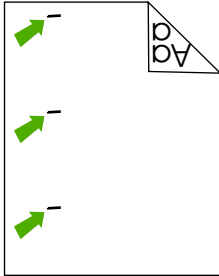
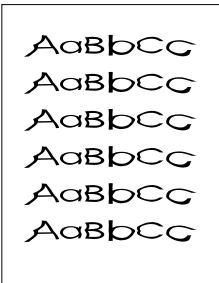
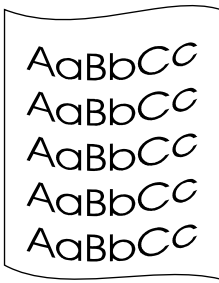
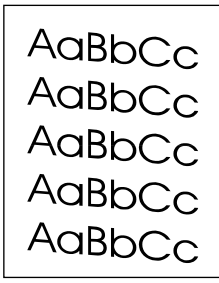

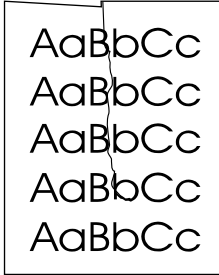
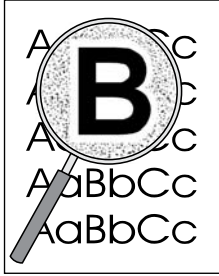
Problem	Cause	Solution
<p>Toner smears appear on the media.</p> 	<p>The media might not meet HP specifications.</p> <p>If toner smears appear on the leading edge of the paper, the media guides are dirty, or debris has accumulated in the print path.</p>	<p>Use media that meets HP specifications.</p> <p>Clean the media guides and the paper path.</p>
<p>The toner smears easily when touched.</p> 	<p>The device is not set to print on the type of media on which you want to print.</p> <p>The media might not meet HP specifications.</p> <p>The paper path might need cleaning.</p>	<p>In the printer driver, select the Paper tab and set Type is to match the type of media on which you are printing. Print speed might be slower if you are using heavy paper.</p> <p>Use media that meets HP specifications.</p> <p>Clean the device.</p>
<p>Marks repeatedly appear at even intervals on the printed side of the page.</p> 	<p>The device is not set to print on the type of media on which you want to print.</p> <p>Internal parts might have toner on them.</p> <p>The paper path might need cleaning.</p> <p>The fuser might be damaged or dirty.</p> <p>A print cartridge may have a problem.</p>	<p>In the printer driver, select the Paper tab and set Type is to match the type of paper on which you are printing. Print speed might be slower if you are using heavy paper.</p> <p>The problem typically corrects itself after a few more pages.</p> <p>Clean the device.</p> <p>Clean using instructions in HP Toolbox.</p> <p>Contact HP Customer Care. See HP Customer Care or the support flyer that came in the device box.</p> <p>To determine which cartridge has a problem, print the PQ diagnostics page from HP Toolbox.</p>



Problem	Cause	Solution
<p>Marks repeatedly appear at even intervals on the unprinted side of the page.</p> 	<p>Internal parts might have toner on them.</p> <p>The paper path might need cleaning.</p> <p>The fuser might be damaged or dirty.</p>	<p>The problem typically corrects itself after a few more pages.</p> <p>Clean the device.</p> <p>Clean using instructions in HP Toolbox.</p> <p>Contact HP Customer Care. See HP Customer Care or the support flyer that came in the device box.</p>
<p>The printed page contains misformed characters.</p> 	<p>The media might not meet HP specifications.</p> <p>If characters are incorrectly formed so that they produce a wavy effect, the laser scanner might need service.</p>	<p>Use a different paper, such as high-quality paper that is intended for color laser printers.</p> <p>Verify that the problem also occurs on the Configuration page. If so, contact HP Customer Care. See HP Customer Care or the support flyer that came in the device box.</p>
<p>The printed page is curled or wavy.</p> 	<p>The device is not set to print on the type of media on which you want to print.</p> <p>The media might not meet HP specifications.</p> <p>Both high temperature and humidity can cause paper curl.</p>	<p>In the printer driver, select the Paper tab and set Type is to match the type of paper on which you are printing. Print speed might be slower if you are using heavy paper.</p> <p>Use a different paper, such as high-quality paper that is intended for color laser printers.</p> <p>Check the device environment.</p>
<p>Text or graphics are skewed on the printed page.</p> 	<p>The media might be loaded incorrectly.</p> <p>The media might not meet HP specifications.</p>	<p>Make sure that the paper or other print media is loaded correctly and that the media guides are not too tight or too loose against the stack. See Loading trays.</p> <p>Use a different paper, such as high-quality paper that is intended for color laser printers.</p>

Problem	Cause	Solution
<p>The printed page contains wrinkles or creases.</p> 	<p>The media might be loaded incorrectly.</p>	<p>Verify that the media is loaded correctly and that the media guides are not too tight or too loose against the stack. See Loading trays.</p> <p>Turn over the stack of paper in the input tray, or try rotating the paper 180° in the input tray.</p>
	<p>The media might not meet HP specifications.</p>	<p>Use a different paper, such as high-quality paper that is intended for color laser printers.</p>
<p>Toner appears around the printed characters.</p> 	<p>The media might be loaded incorrectly.</p>	<p>Turn over the stack of paper in the tray.</p>
	<p>If large amounts of toner have scattered around the characters, the paper might have high resistivity.</p>	<p>Use a different paper, such as high-quality paper that is intended for color laser printers.</p>
<p>An image that appears at the top of the page (in solid black) repeats farther down the page (in a gray field).</p> 	<p>Software settings might affect image printing.</p>	<p>In your software program, change the tone (darkness) of the field in which the repeated image appears.</p> <p>In your software program, rotate the whole page 180° to print the lighter image first.</p>
	<p>The order of images printed might affect printing.</p>	<p>Change the order in which the images are printed. For example, have the lighter image at the top of the page, and the darker image farther down the page.</p>
	<p>A power surge might have affected the device.</p>	<p>If the defect occurs later in a print job, turn the device off for 10 minutes, and then turn on the device to restart the print job.</p>

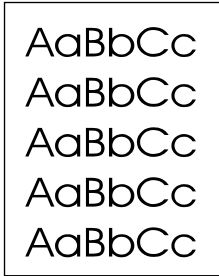
Solving issues with color documents

This section describes issues that can occur when you print in color.

Problem	Cause	Solution
<p>Only black is printing when the document should be printing in color.</p> 	Color mode is not selected in your program or printer driver.	Select color mode instead of grayscale mode.
	The correct printer driver might not be selected in the program.	Select the correct printer driver.
	The device might not be correctly configured.	Print a Configuration page. If no color appears on the Configuration page, contact HP Customer Care. See HP Customer Care or the support flyer that came in the device box.
<p>One or more colors are not printing, or are inaccurate.</p> 	Sealing tape might be on the print cartridges.	Verify that the sealing tape has been completely removed from the print cartridges.
	The media might not meet HP specifications.	Use a different paper, such as high-quality paper that is intended for color laser printers.
	The device might be operating in excessively humid conditions.	Verify that the device environment is within humidity specifications.
	One or more print cartridges might be low. If you are using non-HP print cartridges, no messages appear on the device control panel or in the HP Toolbox.	Replace any low print cartridges.
	The control panel is set for override.	Replace low or empty print cartridges.
<p>A color is printing inconsistently after you load a new print cartridge.</p> 	Another print cartridge might be low. If you are using a non-HP print cartridge, it might be low or empty but you will receive no indication.	Remove the print cartridge for the color that is printing inconsistently and reinstall it.
	The control panel is set for override.	Replace low or empty print cartridges.

Problem	Cause	Solution
<p>The colors on the printed page do not match the colors as they appear on the screen.</p> 	<p>The colors on your computer monitor might differ from the device output.</p>	<p>Select Screen Match in the Color tab of the printer driver.</p>
	<p>If extremely light colors or extremely dark colors on screen are not printing, your software program might interpret extremely light colors as white or extremely dark colors as black.</p>	<p>If possible, avoid using extremely light or extremely dark colors.</p>
	<p>The media might not meet HP specifications.</p>	<p>Use a different paper, such as high-quality paper that is intended for color laser printers.</p>
<p>The finish on the printed color page is inconsistent.</p> 	<p>The media might be too rough.</p>	<p>Use a smooth paper or print media, such as a high-quality paper that is made for color laser printers. Generally, smoother media produces better the results.</p>

Media-handling problems

Use the information in this section when the device experiences media-handling problems.

Print-media guidelines

- For best results, make sure that the paper is of good quality, and free of cuts, nicks, tears, spots, loose particles, dust, wrinkles, voids, staples, and curled or bent edges.
- For best-quality color printing, use a smooth type of paper. Generally, smoother media produces better results.
- If you are unsure what type of paper you are loading (such as bond or recycled), check the label on the package of paper.
- Do not use media that is designed for Inkjet printers only. Use media that is designed for color LaserJet printers.
- Do not use letterhead paper that is printed with low-temperature inks, such as those used in some types of thermography.
- Do not use raised or embossed letterhead.
- The device uses heat and pressure to fuse toner to the paper. Make sure that any colored paper or preprinted forms use inks that are compatible with this fusing temperature (210°C or 410°F for 0.2 second).

CAUTION

Failure to follow these guidelines could cause jams or damage to the device.

Solving print-media problems

The following problems with paper cause print quality deviations, jamming, or even damage to the device.

Problem	Cause	Solution
Poor print quality or toner adhesion	The paper is too moist, too rough, too heavy or too smooth, or it is embossed or from a faulty paper lot.	Verify that the appropriate media type was selected in the printer driver. Try another kind of paper, between 100 and 250 Sheffield, 4% to 6% moisture content.
Dropouts, jamming, or curl	The paper has been stored incorrectly.	Store paper flat in its moisture-proof wrapping.
	The paper has variability from one side to the other.	Turn the paper over.
Excessive curl	The paper is too moist, has the wrong grain direction, or is of short-grain construction.	Verify that the appropriate media type was selected in the printer driver. Try printing on media from a new or different package. Use long-grain paper.
	The paper varies from side-to-side.	Turn the paper over.
Jamming, damage to device	The paper has cutouts or perforations.	Use paper that is free of cutouts or perforations.
Problems with feeding	The paper has ragged edges.	Use high-quality paper that is made for color laser printers.
	The paper varies from side-to-side.	Turn the paper over.
	The paper is too moist, too rough, too heavy or too smooth, has the wrong grain direction, or is of short-grain construction or it is embossed or from a faulty paper lot.	Try another kind of paper, between 100 and 250 Sheffield, 4 to 6% moisture content. Use long-grain paper.
Print is skewed (crooked)	The media guides might be incorrectly adjusted.	Remove all media from the input tray, straighten the stack, and then load the media in the input tray again. Adjust the media guides to the width and length of the media that you are using and try printing again.

Problem	Cause	Solution
More than one sheet feeds at one time.	The media tray might be overloaded.	Remove some of the media from the tray. See Loading trays .
	The media might be wrinkled, folded, or damaged.	Verify that the media is not wrinkled, folded, or damaged. Try printing on media from a new or different package.
Device does not pull media from the media input tray.	The device might be in manual feed mode.	<ul style="list-style-type: none"> If Manual feed appears on the device control-panel display, press  (SELECT) to print the job. Verify that the device is not in manual feed mode and print your job again.
	The media tray might be overloaded.	Remove some of the media from the tray. See Loading trays .
	The paper-length adjustment control in Tray 2 or optional Tray 3 is set at a length that is greater than the media size.	Adjust the paper-length adjustment control to the correct length.
	The pickup roller might be dirty or damaged.	Contact HP Customer Care. See HP Customer Care or the support flyer that came in the device box.

Performance problems

Try the tips in this section if pages exit the device, but have nothing printed on them, or when the device does not print any pages.

Problem	Cause	Solution
Pages print but are totally blank.	The sealing tape might still be in the print cartridges.	Verify that the sealing tape has been completely removed from the print cartridges.
	The document might contain blank pages.	Check the document that you are printing to see if content appears on all of the pages.
	The device might be malfunctioning.	To check the device, print a Configuration page.
Pages print very slowly.	Heavier media types can slow the print job.	Print on a different type of media.
	Complex pages will print slower	Proper fusing may require a slower print speed to ensure the best print quality.

Problem	Cause	Solution
Pages did not print.	The device might not be pulling media correctly.	See Media-handling problems .
	The media is jamming in the device.	Clear the jam.
	The USB cable might be defective or incorrectly connected.	<ul style="list-style-type: none"> ● Disconnect the USB cable at both ends and reconnect it. ● Try printing a job that has printed in the past. ● Try using a different USB cable.
	Other devices are running on your computer.	The device might not share a USB port. If you have an external hard drive or network switchbox that is connected to the same port as the device, the other device might be interfering. To connect and use the device, you must disconnect the other device or you must use two USB ports on the computer.



Troubleshooting tools

The section describes the tools that can help you solve problems with your device.

Device pages and reports







This section describes the pages and reports that help you diagnose and solve problems with the device.

Demo page

To print the Demo page, press the  (LEFT ARROW) and  (RIGHT ARROW) buttons on the printer control panel simultaneously. You can also print this page from the HP Toolbox.

Configuration page







The Configuration page lists the current settings and properties of the printer. You can print a Configuration page from the printer or HP Toolbox. To print the Configuration page from the printer, complete the following steps.

1. Press the  (LEFT ARROW) or the  (RIGHT ARROW) to select the **Reports** menu.
2. Press  (SELECT).
3. Press the  (LEFT ARROW) or the  (RIGHT ARROW) to select **Config report**.
4. Press  (SELECT) to print the Configuration page.

For more information about the Configuration page, see [Configuration page](#).

Supplies Status page

The Supplies Status page lists the remaining life of the HP print cartridges. It also lists the estimated pages remaining, number of pages printed, and other supplies information. You can print a Supplies Status page from the device or HP Toolbox. To print from the device, complete the following steps.

1. Press the  (LEFT ARROW) or the  (RIGHT ARROW) to select the **Reports**.
2. Press  (SELECT).
3. Use the  (LEFT ARROW) or the  (RIGHT ARROW) to select **Supplies Status**.
4. Press  (SELECT) to print the Supplies Status page.

For more information about the Supplies Status page, see [Supplies Status page](#).

HP Toolbox

HP Toolbox is a Web application that you can use for troubleshooting tasks.

To view HP Toolbox

Open HP Toolbox in one of these ways:

- On the Windows desktop, double-click the HP Toolbox icon.
- On the Windows **Start** menu, click **Programs** (**All Programs** in Windows XP), click **HP**, click **HP Color LaserJet 2600n**, and then click **HP Color LaserJet 2600n Toolbox**.

Troubleshooting tab

HP Toolbox includes a **Troubleshooting** tab that contains links to the following main pages:

- **Control Panel Messages**. View descriptions of device control-panel messages.
- **Clearing Jams**. View information about locating and clearing jams.
- **Print Problems**. View Help topics that can help you solve print problems.
- **Memory Card Problems**. View Help topics that can help you solve memory-card problems.
- **Connectivity Problems**. View Help topics that can help you solve networking problems.
- **Troubleshooting Tools**. Employ such troubleshooting tools as a cleaning page or a color troubleshooting page to maintain the device.

NOTE

Other tabs on HP Toolbox might be helpful in troubleshooting device problems. For information about the other tabs on HP Toolbox, see [HP Toolbox](#).

Service menu

Use the control-panel **Service** menu to troubleshoot device problems.

Restoring the factory-set defaults

Restoring the factory-set defaults returns all of the settings to the factory defaults.

To restore the factory-set defaults

1. Use the  (**LEFT ARROW**) or the  (**RIGHT ARROW**) button to select **Service**, and then press  (**SELECT**).
2. Use the  (**LEFT ARROW**) or the  (**RIGHT ARROW**) button to select **Restore defaults**, and then press  (**SELECT**).

The device automatically restarts.







Cleaning the paper path

The device features a special cleaning mode to clean the paper path.

NOTE

If you have access to HP Toolbox, HP recommends cleaning the paper path by using HP Toolbox.

To clean the paper path

1. Use the  (LEFT ARROW) or the  (RIGHT ARROW) button to select **Service**, and then press  (SELECT).
2. Use the  (LEFT ARROW) or the  (RIGHT ARROW) button to select **Cleaning Mode**, and then press  (SELECT).











A page feeds through the printer slowly. Discard the page when the process is completed.

3. Load plain letter or A4 paper when you are prompted.
4. Press  (SELECT) again to confirm and begin the cleaning process.

A page feeds through the printer slowly. Discard the page when the process is completed.

Calibrating the printer

Calibrations are performed at regular intervals. For best print quality, a calibration can be performed from the control panel using the following steps:

1. Use the  (LEFT ARROW) or the  (RIGHT ARROW) button to select **System setup** and then press  (SELECT).
2. Use the  (LEFT ARROW) or the  (RIGHT ARROW) button to select **Print quality** and then press  (SELECT). **Calibrate color** will display on the control panel.
3. Press  (SELECT).
4. Use the  (LEFT ARROW) or the  (RIGHT ARROW) button to select **Calibrate now** and then press  (SELECT).
5. Press  (SELECT) to start the calibration.

A

Accessories and ordering information

The following list of accessories was current at the time of printing. Ordering information and availability of the accessories might change during the life of the printer. For the most current ordering information, visit the most appropriate of the following websites:

- North America: <http://www.hp.com>
- Europe and Middle East: <http://www.hp.com>
- Asia Pacific countries/regions: <http://www.hp.com>
- Latin America: <http://www.hp.com>

Supplies

Product name	Description	Part number
Black print cartridge	Life of 2,500 pages at approximately 5% coverage.	Q6000A
Cyan print cartridge	Life of 2,000 pages at approximately 5% coverage.	Q6001A
Yellow print cartridge	Life of 2,000 pages at approximately 5% coverage.	Q6002A
Magenta print cartridge	Life of 2,000 pages at approximately 5% coverage.	Q6003A

NOTE

Actual yields may vary according to usage.

Cable and interface accessories

Product name	Description	Part number
USB cable	2-meter standard USB-compatible device connector	C6518A

Paper handling accessories

Product name	Description	Part number
Optional Tray 3	Optional 250-sheet universal input tray. Only one optional 250-sheet tray can be installed.	Q6459A

Paper and other print media

Product name	Description	Part number
HP LaserJet paper	Premium HP-brand paper for use with HP LaserJet printers.	HPJ1124 (letter)
HP LaserJet paper	Premium HP-brand paper for use with HP LaserJet printers.	CHP310 (A4)
HP LaserJet paper	Premium HP-brand paper for use with HP LaserJet printers.	HPJ1424 (legal)
HP Premium Choice paper	HP bond paper with a weight of 120.32 g/m ² (32 lb)	HPU1132 (letter)
HP Premium Choice paper	HP bond paper with a weight of 120.32 g/m ² (32 lb)	CHP410 (A4)
HP Cover paper	HP-brand paper with a weight of 200 g/m ² (75 lb) cover. Use for printing postcards and document covers.	Q2413A (letter) 100 sheets
HP Cover paper	HP-brand paper with a weight of 200 g/m ² (75 lb) cover. Use for printing postcards and document covers.	Q2414A (A4) 100 sheets
HP Printing paper	HP-brand paper for use with HP LaserJet printers.	HPP1122 (letter)
HP Printing paper	HP-brand paper for use with HP LaserJet printers.	CHP210 (A4)
HP Multipurpose paper	HP-brand paper for a variety of uses.	HPM1120 (letter)
HP Multipurpose paper	HP-brand paper for a variety of uses.	HPM1420 (legal)
HP LaserJet Tough paper	Robust paper with a satin finish. Paper will not tear and will withstand the weather. For documents requiring durability and longevity.	Q1298A (letter)
HP LaserJet Tough paper	Robust paper with a satin finish. Paper will not tear and will withstand the weather. For documents requiring durability and longevity.	Q1298B (A4)
HP Glossy Photo & Imaging laser paper	High-gloss finish coating on both sides. Use for brochures, catalogs, photographs, and whenever a high-gloss finish is desired.	Q6545A (letter) 200 sheets

Product name	Description	Part number
HP Laser Photo Paper, Glossy	High-gloss finish coating on both sides. Use for brochures, catalogs, photographs, and whenever a high-gloss finish is desired.	Q6547A (A4) 200 sheets
HP Soft Gloss Presentation laser paper	Satin finish coating on both sides. 120 g/m ² (32 lb)	Q6541A (letter) 200 sheets
HP Laser Paper, Soft Gloss	Satin finish coating on both sides. 120 g/m ² (32 lb)	C6542A (A4) 200 sheets
HP Soft Gloss laser paper	Satin finish coating on both sides. 105 g/m ² (28 lb)	Q2415A (letter) 500 sheets
HP Soft Gloss laser paper	Satin finish coating on both sides. 105 g/m ² (28 lb)	Q2417A (A4) 500 sheets
HP Color LaserJet transparencies	Use color transparencies for full-color printing.	C2934A (letter) 50 sheets
HP Color LaserJet transparencies	Use color transparencies for full-color printing.	C2936A (A4) 50 sheets
HP Matte Photo & Imaging laser paper	Matte finish paper for photos and imaging. 120 g/m ² (32 lb)	Q6549A (letter) 100 sheets
HP Laser Photo paper, Matte	Matte finish paper for photos and imaging. 120 g/m ² (32 lb)	Q6550A (A4) 100 sheets
HP Matte Brochure laser paper	Matte finish paper. Use for brochures, catalogs, and so on. 160 g/m ² (52 lb)	Q6543A (letter) 150 sheets
HP Laser Paper, Matte	Matte finish paper. Use for brochures, catalogs, and so on. 160 g/m ² (52 lb)	Q6544A (A4) 150 sheets

User-replaceable parts

Product name	Description	Part number
Separation pad and pick-up rollers	Replace when the printer is picking up multiple sheets or no sheets. Trying different paper did not resolve the problem.	Q5956-67902
Paper tray	A 250-sheet paper tray cassette.	Q5956-67901
Dust cover	Protects the output of paper cassette from dust.	Q5956-67903
Output tray extender	An extension for supporting paper in the output bin.	Q5956-67904

Supplementary Documentation

A printed copy of this user guide is available in the following languages.

User guides

Language	Part number
English	Q6455-90901
Arabic	Q6455-90902
Catalan	Q6455-90903
Chinese (Simplified)	Q6455-90918
Chinese (Traditional)	Q6455-90921
Czech	Q6455-90904
Danish	Q6455-90905
Dutch	Q6455-90906
Finnish	Q6455-90907
French	Q6455-90908
German	Q6455-90909
Hebrew	Q6455-90910
Hungarian	Q6455-90911
Indonesian (Bahasa)	Q6455-90924
Italian	Q6455-90912
Korean	Q6455-90913
Norwegian	Q6455-90914
Portuguese (Brazilian)	Q6455-90916
Polish	Q6455-90915
Russian	Q6455-90917
Spanish	Q6455-90919
Swedish	Q6455-90920
Thai	Q6455-90922
Turkish	Q6455-90923



Service and support

Hewlett-Packard limited warranty statement

HP PRODUCT
HP Color LaserJet 2600n

DURATION OF LIMITED WARRANTY
1 year, Limited Warranty

HP warrants to you, the end-user customer, that HP hardware and accessories will be free from defects in materials and workmanship after the date of purchase, for the period specified above. If HP receives notice of such defects during the warranty period, HP will, at its option, either repair or replace products which prove to be defective. Replacement products may be either new or equivalent in performance to new.

HP warrants to you that HP software will not fail to execute its programming instructions after the date of purchase, for the period specified above, due to defects in material and workmanship when properly installed and used. If HP receives notice of such defects during the warranty period, HP will replace software which does not execute its programming instructions due to such defects.

HP does not warrant that the operation of HP products will be uninterrupted or error free. If HP is unable, within a reasonable time, to repair or replace any product to a condition as warranted, you will be entitled to a refund of the purchase price upon prompt return of the product.

HP products may contain remanufactured parts equivalent to new in performance or may have been subject to incidental use.

Warranty does not apply to defects resulting from (a) improper or inadequate maintenance or calibration, (b) software, interfacing, parts or supplies not supplied by HP, (c) unauthorized modification or misuse, (d) operation outside of the published environmental specifications for the product, or (e) improper site preparation or maintenance.

TO THE EXTENT ALLOWED BY LOCAL LAW, THE ABOVE WARRANTIES ARE EXCLUSIVE AND NO OTHER WARRANTY OR CONDITION, WHETHER WRITTEN OR ORAL, IS EXPRESSED OR IMPLIED AND HP SPECIFICALLY DISCLAIMS ANY IMPLIED WARRANTIES OR CONDITIONS OF MERCHANTABILITY, SATISFACTORY QUALITY, AND FITNESS FOR A PARTICULAR PURPOSE. Some countries/regions, states or provinces do not allow limitations on the duration of an implied warranty, so the above limitation or exclusion might not apply to you. This warranty gives you specific legal rights and you might also have other rights that vary from country/region to country/region, state to state, or province to province. HP's limited warranty is valid in any country/region or locality where HP has a support presence for this product and where HP has marketed this product. The level of warranty service you receive may vary according to local standards. HP will not alter form, fit or function of the product to make it operate in a country/region for which it was never intended to function for legal or regulatory reasons.

TO THE EXTENT ALLOWED BY LOCAL LAW, THE REMEDIES IN THIS WARRANTY STATEMENT ARE YOUR SOLE AND EXCLUSIVE REMEDIES. EXCEPT AS INDICATED ABOVE, IN NO EVENT WILL HP OR ITS SUPPLIERS BE LIABLE FOR LOSS OF DATA OR FOR DIRECT, SPECIAL, INCIDENTAL, CONSEQUENTIAL (INCLUDING LOST PROFIT OR DATA), OR OTHER DAMAGE, WHETHER BASED IN CONTRACT, TORT, OR OTHERWISE. Some countries/regions, states or provinces do not allow the exclusion or limitation of incidental or consequential damages, so the above limitation or exclusion may not apply to you.

THE WARRANTY TERMS CONTAINED IN THIS STATEMENT, EXCEPT TO THE EXTENT LAWFULLY PERMITTED, DO NOT EXCLUDE, RESTRICT OR MODIFY AND ARE IN ADDITION TO THE MANDATORY STATUTORY RIGHTS APPLICABLE TO THE SALE OF THIS PRODUCT TO YOU.

Print Cartridge Limited Warranty Statement

This HP product is warranted to be free from defects in materials and workmanship.

This warranty does not apply to products that (a) have been refilled, refurbished, remanufactured or tampered with in any way, (b) experience problems resulting from misuse, improper storage, or operation outside of the published environmental specifications for the printer product or (c) exhibit wear from ordinary use.

To obtain warranty service, please return the product to place of purchase (with a written description of the problem and print samples) or contact HP Customer Support. At HP's option, HP will either replace products that prove to be defective or refund your purchase price.

TO THE EXTENT ALLOWED BY LOCAL LAW, THE ABOVE WARRANTY IS EXCLUSIVE AND NO OTHER WARRANTY OR CONDITION, WHETHER WRITTEN OR ORAL, IS EXPRESSED OR IMPLIED AND HP SPECIFICALLY DISCLAIMS ANY IMPLIED WARRANTIES OR CONDITIONS OF MERCHANTABILITY, SATISFACTORY QUALITY, AND FITNESS FOR A PARTICULAR PURPOSE.

TO THE EXTENT ALLOWED BY LOCAL LAW, IN NO EVENT WILL HP OR ITS SUPPLIERS BE LIABLE FOR DIRECT, SPECIAL, INCIDENTAL, CONSEQUENTIAL (INCLUDING LOST PROFIT OR DATA), OR OTHER DAMAGE, WHETHER BASED IN CONTRACT, TORT, OR OTHERWISE.

THE WARRANTY TERMS CONTAINED IN THIS STATEMENT, EXCEPT TO THE EXTENT LAWFULLY PERMITTED, DO NOT EXCLUDE, RESTRICT OR MODIFY AND ARE IN ADDITION TO THE MANDATORY STATUTORY RIGHTS APPLICABLE TO THE SALE OF THIS PRODUCT TO YOU.

Availability of support and service

Around the world, HP provides a variety of service and support options for purchase. Availability of these programs will vary depending upon your location.

HP Care Pack™ Services and Service Agreements

HP has various service and support options that meet a wide range of needs. These options are not part of the standard warranty. Support services may vary by location. For most printers HP offers both in-warranty and post-warranty HP Care Pack Services and Service Agreements.

To identify service and support options for this printer go to <http://www.hpexpress-services.com/10467a> and type the printer model number. In North America, Service Agreement information can be obtained through HP Customer Care. Call 1-800-HPINVENT 1-800-474-6836 (U.S.) or 1-800-268-1221 (Canada). In other countries/regions please contact your country/region specific HP Customer Care Center. See the inbox flyer or go to <http://welcome.hp.com/country/us/en/wwcontact.html> for the HP Customer Care phone number in your country/region.

Repacking the printer

If your printer needs to be moved or shipped to another location, perform the following procedure to repack the printer.

CAUTION

Shipping damage as a result of inadequate packing is the customer's responsibility. To ensure proper protection during shipment, the printer must be repackaged properly using the original cushions.

To repack the printer

CAUTION

It is *extremely important* to remove the print cartridges before shipping the printer. Print cartridges left in the printer during shipping will leak and entirely cover the printer engine and other parts with toner.

To prevent damage to the print cartridge, avoid touching the roller, and store the print cartridge in its original packing material or so that it is not exposed to light.

1. Remove all four print cartridges.
2. If you have added optional Tray 3, remove and retain.
3. Remove and retain the power cable and interface cable.
4. Remove and retain the optional HP Jetdirect external print server, if you have one.
5. If possible, include print samples and 50 to 100 sheets of paper or other print media that did not print correctly.
6. Use the original shipping container and packing material, if possible. If you have already disposed of the printer packing material, contact a local mailing service for information about repacking the printer. HP recommends insuring the equipment for shipment.
7. Include a completed copy of the [Service information form](#).
8. In the U.S., call HP Customer Care to request new packing material. In other areas, use the original packing material, if possible. Hewlett-Packard recommends insuring the equipment for shipment.

Service information form

WHO IS RETURNING THE EQUIPMENT?		Date:
Person to contact:		Phone:
Alternate contact:		Phone:
Return shipping address:	Special shipping instructions:	
WHAT ARE YOU SENDING?		
Model name:	Model number:	Serial number:
Please attach any relevant printouts. Do NOT ship accessories (manuals, cleaning supplies, and so on) that are not required to complete the repair.		
HAVE YOU REMOVED THE PRINT CARTRIDGES?		
You must remove them before shipping the printer, unless a mechanical problem prevents you from doing so.		
<input type="checkbox"/> Yes.	<input type="checkbox"/> No, I cannot remove them.	
WHAT NEEDS TO BE DONE? (Attach a separate sheet if necessary.)		
1. Describe the conditions of the failure. (What was the failure? What were you doing when the failure occurred? What software were you running? Is the failure repeatable?)		
2. If the failure is intermittent, how much time elapses between failures?		
3. If the unit connected to any of the following, give the manufacturer and model number.		
Personal computer:	Modem:	Network:
4. Additional comments:		
HOW WILL YOU PAY FOR THE REPAIR?		
<input type="checkbox"/> Under warranty	Purchase/received date:	
(Attach proof of purchase or receiving document with original received date.)		
<input type="checkbox"/> Maintenance contract number:		
<input type="checkbox"/> Purchase order number:		
Except for contract and warranty service, a purchase order number and/or authorized signature must accompany any request for service. If standard repair prices do not apply, a minimum purchase order is required. Standard repair prices can be obtained by contacting an HP-authorized repair center.		
Authorized signature:		Phone:
Billing address:	Special billing instructions:	



Specifications

Printer specifications

Physical specifications

Product	Height	Depth	Width	Weight
HP Color LaserJet 2600n printer without optional Tray 3 or consumables	370 mm (14.6 in)	453 mm (17.83 in)	407 mm (16.02 in)	15.67 kg (34.54 lbs)
HP Color LaserJet 2600n printer with optional Tray 3 (250-sheet), without consumables	460 mm (18.1 in)	451 mm (17.76 in)	482 mm (18.98 in)	20.16 kg (44.43 lbs)

Supplies specifications

Print-cartridge life (based on approximately 5% coverage)	Black: 2,500 pages Yellow, cyan, and magenta: 2,000 pages each (HP Color LaserJet 2600n printer)
---	---

Electrical specifications

Item	110-Volt models	220-Volt models
Power supply	115-127V (+/-10%) 50/60 Hz (+/- 2 Hz)	220-240V (+/-10%) 50/60 Hz (+/- 2 Hz)
Power consumption (typical)		
During printing (color)	190 W (average)	190 W (average)
During printing (black and white)	190 W (average)	190 W (average)
During standby	16 W (average)	16 W (average)
Off mode	0 W (average)	0 W (average)

Electrical specifications (continued)

Item	110-Volt models	220-Volt models
Heat output Ready Mode	55 BTU/hour	55 BTU/hour
Rated current	3.6 Amps	2.5 Amps

CAUTION

Power requirements are based on the country/region where the printer is sold. Do not convert operating voltages. This will damage the printer and void the product warranty.

Environmental specifications

	Recommended ¹	Operating ¹	Storage ¹
(printer and print cartridge) Temperature	20° to 27°C (68° to 81°F)	15° to 32.5°C (59° to 90.5°F)	-20° to 40°C (-4° to 104°F)
Relative humidity	20% to 70%	10% to 80%	95% or less

¹ Values are subject to change. See <http://www.hp.com/support/clj2600n> for current information.

Acoustic emissions

Sound Power Level	Declared per ISO 9296 ¹
Printing (8 ppm)	$L_{WAd} = 6.0$ Bels (A) [60 dB (A)]
SPL-Bystander Position	Declared per ISO 9296 ¹
Printing (8 ppm)	$L_{pAm} = 52$ dB(A)

¹ Values are subject to change. See <http://www.hp.com/support/clj2600n> for current information.

D

Regulatory information

Introduction

This section contains the following regulatory information:

- [FCC regulations](#)
- [Environmental Product Stewardship program](#)
- [Material safety data sheet](#)
- [Declaration of conformity](#)
- [Laser safety statement](#)
- [Canadian DOC statement](#)
- [Korean EMI statement](#)
- [VCCI statement \(Japan\)](#)
- [Finnish laser statement](#)

FCC regulations

This equipment has been tested and found to comply with the limits for a Class B digital device, pursuant to Part 15 of the FCC rules. These limits are designed to provide reasonable protection against harmful interference in a residential installation. This equipment generates, uses, and can radiate radio frequency energy. If this equipment is not installed and used in accordance with the instructions, it may cause harmful interference to radio communications. However, there is no guarantee that interference will not occur in a particular installation; the presence of interference can be determined by turning the equipment off and on. If this equipment does cause harmful interference to radio or television communications, the user is encouraged to try to correct the interference by one or more of the following measures:

- Reorient or relocate the receiving antenna.
- Increase distance between equipment and receiver.
- Connect equipment to an outlet on a circuit different from that to which the receiver is located.
- Consult your dealer or an experienced radio/television technician.

NOTE

Any changes or modifications to the printer that are not expressly approved by HP could void the user's authority to operate this equipment.

Use of a shielded interface cable is required to comply with the Class B limits of Part 15 of FCC rules.

Environmental Product Stewardship program

Protecting the environment

Hewlett-Packard Company is committed to providing quality products in an environmentally sound manner. This product has been designed with several attributes to minimize impacts on our environment.

Ozone production

This product generates no appreciable ozone gas (O₃).

Energy consumption

This product qualifies for ENERGY STAR®, which is a voluntary program established to encourage the development of energy-efficient office products.



Power usage drops significantly while in sleep mode, which saves natural resources and saves money without affecting the high performance of this product.

ENERGY STAR (version 3.0) is a U.S. registered service mark of the U.S. Environmental Protection Agency. As an ENERGY STAR partner, Hewlett-Packard Company has determined that this product meets ENERGY STAR Guidelines for energy efficiency. For more information, see <http://www.energystar.gov>.

Paper use

This product's manual duplex feature (two-sided printing); see [Printing on both sides](#) and N-up printing [multiple pages printed on one sheet] capability can reduce paper usage and the resulting demands on natural resources.

Plastics

Plastic parts over 25 grams are marked according to international standards that enhance the ability to identify plastics for recycling purposes at the end of the product's life.

HP LaserJet printing supplies

In many countries/regions, this product's printing supplies (for example, print cartridge) can be returned to HP through the HP Printing Supplies Returns and Recycling Program. An easy-to-use and free takeback program is available in over 30 countries/regions. Multi-lingual program information and instructions are included in every new HP LaserJet print cartridge and supplies package.

HP Printing Supplies Returns and Recycling Program Information

Since 1992, HP has offered HP LaserJet supplies return and recycling free of charge in 86% of the world market where HP LaserJet supplies are sold. Postage-paid and pre-addressed labels are included within the instruction guide in most HP LaserJet print cartridge boxes. Labels and bulk boxes are also available through the website: <http://www.hp.com/recycle>.

More than 10 million HP LaserJet print cartridges were recycled globally in 2002 through the HP Planet Partners supplies recycling program. This record number represents 26 million pounds of print cartridge materials diverted from landfills. Worldwide, HP recycled an average of 80% of the print cartridge by weight consisting primarily of plastic and metals. Plastics and metals are used to make new products such as HP products, plastic trays and spools. The remaining materials are disposed of in an environmentally responsible manner.

U.S. returns

For a more environmentally responsible return of used cartridges and supplies, HP encourages the use of bulk returns. Simply bundle two or more cartridges together and use the single, pre-paid, pre-addressed UPS label that is supplied in the package. For more information in the U.S., call 1-800-340-2445 or visit the HP Printing Supplies Returns and Recycling Program website at: <http://www.hp.com/go/recycle>.

Non-U.S. returns

Non-U.S. customers should visit the <http://www.hp.com/go/recycle> website for further information regarding availability of the HP Supplies Returns and Recycling program.

Paper

This product is capable of using recycled papers, when the paper meets the guidelines outlined in the *HP LaserJet Printer Family Print Media Guide*. Go to <http://www.hp.com/support/ljpaperguide> to download this guide in PDF format. This product is suitable for the use of recycled paper according to EN12281:2002.

Material restrictions

This product does not contain added mercury.

This product does not contain batteries.

For recycling information, you can contact <http://www.hp.com/go/recycle> or contact your local authorities or the Electronics Industry Alliance at <http://www.eiae.org>.

Material safety data sheet

Material Safety Data Sheets (MSDS) for supplies containing chemical substances, such as toner, can be obtained by contacting the HP website at <http://www.hp.com/go/msds> or <http://www.hp.com/hpinfo/community/environment/productinfo/safety>.

Extended warranty

HP SupportPack provides coverage for the HP hardware product and all HP-supplied internal components. The hardware maintenance covers a three-year period from the date of the HP product purchase. The customer must purchase HP SupportPack within 90 days of the HP product purchase. For more information, contact the HP Customer Care Service and HP Customer Support Group. See [HP Customer Care](#).

Spare parts and supplies availability

Spare parts and consumable supplies for this product will be available for at least five years after production has stopped.

For more information

To obtain information about these environmental topics:

- Product environmental profile sheet for this and many related HP products
- HP's commitment to the environment
- HP's environmental management system
- HP's end-of-life product return and recycling program
- MSDS

See: <http://www.hp.com/go/environment> or <http://www.hp.com/hpinfo/community/environment/productinfo/safety>.

Declaration of conformity

Declaration of Conformity

according to ISO/IEC Guide 22 and EN 45014

Manufacturer's Name: Hewlett-Packard Company
Manufacturer's Address: 11311 Chinden Boulevard,
Boise, Idaho 83714-1021, USA

declares, that the product

Product Name: HP Color LaserJet 2600n
Regulatory Model Number³⁾: BOISB-0409-00. Including: Q6459A – Optional 250-sheet input tray
Product Options: ALL

conforms to the following Product Specifications:

Safety: IEC60950:2001-1 / EN60950: 2001-1
IEC 60825-1:1993 +A1: 1997 +A2:2001 / EN 60825-1:1994 +A11:1996 +A2:2001 (Class 1 Laser/LED Product)
GB4943-2001

EMC: CISPR 22:1997 / EN 55022:1998 Class B¹⁾
EN 61000-3-2:2000
EN 61000-3-3:1995/ A1:2001
EN 55024:1998
FCC Title 47 CFR, Part 15 Class B²⁾ / ICES-003, Issue 4/ GB9254-1998, GB17625.1-1998

Supplementary Information:

The product herewith complies with the requirements of the EMC Directive 89/336/EEC and the Low Voltage Directive 73/23/EEC, and carries the CE-Marking accordingly.

1) The product was tested in a typical configuration with Hewlett-Packard Personal Computer Systems. Compliance testing of product to standard with exception of Clause 9.5, which is not yet in effect.

2) This Device complies with Part 15 of the FCC Rules. Operation is subject to the following two conditions: (1) this device may not cause harmful interference, and (2) this device must accept any interference received, including interference that may cause undesired operation.

3) For regulatory purposes, this product is assigned a Regulatory model number. This number should not be confused with the product name or the product number(s).

Boise, Idaho 83714-1021, USA

February 24th, 2005

For regulatory topics only:

Australia Contact: Product Regulations Manager, Hewlett-Packard Australia Ltd., 31-41 Joseph Street, Blackburn, Victoria 3130, Australia

European Contact: Your Local Hewlett-Packard Sales and Service Office or Hewlett-Packard GmbH, Department HQ-TRE / Standards Europe, Herrenberger Strasse 140, D-71034 Böblingen, Germany, (FAX: +49-7031-14-3143)

USA Contact: Product Regulations Manager, Hewlett-Packard Company, PO Box 15, Mail Stop 160, Boise, Idaho 83707-0015, USA (Phone: 208-396-6000)

Country/region-specific safety statements

Laser safety statement

The Center for Devices and Radiological Health (CDRH) of the U.S. Food and Drug Administration has implemented regulations for laser products manufactured since August 1, 1976. Compliance is mandatory for products marketed in the United States. The printer is certified as a "Class 1" laser product under the U.S. Department of Health and Human Services (DHHS) Radiation Performance Standard according to the Radiation Control for Health and Safety Act of 1968.

Since radiation emitted inside the printer is completely confined within protective housings and external covers, the laser beam cannot escape during any phase of normal user operation.

WARNING!

Using controls, making adjustments, or performing procedures other than those specified in this user guide may result in exposure to hazardous radiation.

Canadian DOC statement

Complies with Canadian EMC Class B requirements.

« Conforme à la classe B des normes canadiennes de compatibilité électromagnétiques (CEM). »

Korean EMI statement

사용자 안내문 (B 급 기기)

이 기기는 비업무용으로 전자파장해검정을 받은 기기로서, 주거지역에서는 물론 모든 지역에서 사용할 수 있습니다.

VCCI statement (Japan)

この装置は、情報処理装置等電波障害自主規制協議会（VCCI）の基準に基づくクラスB情報技術装置です。この装置は、家庭環境で使用することを目的としていますが、この装置がラジオやテレビジョン受信機に近接して使用されると、受信障害を引き起こすことがあります。
取り扱い説明書に従って正しい取り扱いをして下さい。

Finnish laser statement

LASERTURVALLISUUS

LUOKAN 1 LASERLAITE

KLASS 1 LASER APPARAT

HP Color LaserJet 2600n -laserkirjoitin on käyttäjän kannalta turvallinen luokan 1 laserlaite. Normaalisissa käytössä kirjoittimen suojakotelointi estää lasersäteen pääsyn laitteen ulkopuolelle.

Laitteen turvallisuusluokka on määritetty standardin EN60825-1 (1994) mukaisesti.

VAROITUS!

Laitteen käyttäminen muulla kuin käyttöohjeessa mainitulla tavalla saattaa altistaa käyttäjän turvallisuusluokan 1 ylittävälle näkymättömälle lasersäteilylle.

WARNING!

Om apparaten används på annat sätt än i bruksanvisning specificerats, kan användaren utsättas för osynlig laserstrålning, som överskrider gränsen för laserklass 1.

HUOLTO

HP Color LaserJet 2600n -kirjoittimen sisällä ei ole käyttäjän huollettavissa olevia kohteita. Laitteen saa avata ja huoltaa ainoastaan sen huoltamiseen koulutettu henkilö. Tällaiseksi huoltotoimenpiteeksi ei katsota väriainekasetin vaihtamista, paperiradan puhdistusta tai muita käyttäjän käsikirjassa lueteltuja, käyttäjän tehtäväksi tarkoitettuja ylläpitotoimia, jotka voidaan suorittaa ilman erikoistyökaluja.

VARO!

Mikäli kirjoittimen suojakotelo avataan, olet alttiina näkymättömälle lasersäteilylle laitteen ollessa toiminnassa. Älä katso säteeseen.

WARNING!

Om laserprinterns skyddshölje öppnas då apparaten är i funktion, utsättas användaren för osynlig laserstrålning. Betrakta ej strålen.

Tiedot laitteessa käytettävän laserdiodin säteilyominaisuuksista:

Aallonpituus 770-800 nm

Teho 5 mW

Luokan 3B laser

Index

Symbols/Numerics

- 250-sheet tray. *See* tray 2
- 4-Color option 65
- 600 dpi print-quality setting 109

A

- accessories
 - part numbers 124
- Adaptive Halftoning options 65
- adding paper 40
- adhesive labels
 - printing 46
 - specifications 16, 17
- agreements, maintenance 134, 143
- Alerts tab, HP Toolbox 85
- Apple LaserWriter 8 driver 11
- Apple Macintosh. *See* Macintosh
- applications, settings 9
- Attention light 21, 123
 - See also* lights

B

- background, gray 111
- bands, troubleshooting 111
- battery specifications 142
- bins, output
 - features 5
 - jams, clearing 108
- black and white printing
 - selecting 53
 - troubleshooting 115
- Black cartridge
 - life expectancy 92
 - part number 124
 - status gauge 20
 - See also* cartridges
- Black Only option 65
- blank pages, troubleshooting 118
- blinking lights 101
- BOOTP/TFTP
 - configuring 30
- both sides, printing on 58
- browser requirements 84
- built-in networking
 - information page, printing 80
- buttons, control panel 19

C

- cables
 - USB, troubleshooting 119
- calibrating printer 96
- Cancel Job button 20, 60
- cardstock
 - printing on 51
 - specifications 17
- cartridge out override 94
- cartridges
 - HP fraud hotline 93
 - life expectancy 92
 - part numbers 124
 - recycling 141
 - replacing 93
 - status gauge 20
 - status page, printing 81
 - storage specifications 138
- characters, troubleshooting 113
- clearing jams
 - common locations 105
 - input areas 107
 - inside printer 106
 - output areas 108
- color
 - calibration 96
 - features 62
 - grayscale, printing as 53
 - HP ImageREt 2400 62
 - Manual adjustment options 64
 - matching 66
 - settings, changing 64
 - sRGB 66
 - troubleshooting 114
- components
 - locating 7
- Configuration page
 - printing 80
- configurations
 - AutoIP 27
 - manual TCP/IP 27
 - network 23, 24
 - server-based 27
 - TCP/IP 28
- configurations, printer 4

- consumables
 - availability 143
 - life expectancies 92
 - part numbers 124
 - recycling 141
 - specifications 137
 - status gauge 20
 - status page, printing 81
- contracts, maintenance 134, 143
- control panel
 - lights and buttons, description 19
 - messages, troubleshooting 101
- covers, document
 - cardstock, printing on 51
 - paper specifications 17
 - using different paper for 55
- creases, troubleshooting 114
- crooked pages 113, 117
- curled media 113
- custom paper sizes 51, 53
- customer support
 - maintenance agreements 134, 143
 - repacking printer 135
 - service information form 136
- Cyan cartridge
 - life expectancy 92
 - part number 124
 - status gauge 20
 - See *also* cartridges

D

- declaration of conformity 144
- default settings, restoring 55
- deleting print jobs 60
- Demo page, printing 80
- Detail halftone option 64
- device discovery 25
- Device Settings, HP Toolbox 86
- different first page 55
- digital cameras, color matching 66
- dimensions, media. See sizes, media
- dimensions, printer 137
- display
 - control panel 20
- documentation 86, 130
- Documentation tab, HP Toolbox 86
- dots per inch (dpi)
 - HP ImageREt 2400 62
 - print settings 109
 - specifications 5
- dots, troubleshooting 111
- double-sided printing 58
- downloading drivers 10
- dpi (dots per inch)
 - HP ImageREt 2400 62
 - print settings 109
 - specifications 5

- drivers
 - downloading 10
 - features 53
 - opening 52
 - operating systems supported 9
 - restoring default settings 55
 - settings, changing 56
 - uninstalling 11
 - Windows, features 10
- duplexing 58

E

- Edge Control 65
- electrical specifications 137
- embedded Web server
 - using 87
- energy consumption 137, 141
- engine, cleaning 95
- enlarging documents 54
- envelopes
 - printing 44
 - specifications 14, 17
- environmental
 - features 141
 - paper specifications 14
 - printer specifications 138
- error messages
 - control panel 101
 - critical 102
- Explorer, versions supported 84
- extended warranty 134, 143

F

- face down bin. See top output bin
- face up bin. See rear output door
- faded print 110
- FCC statements 140
- features
 - color 62
 - drivers 53
- feeding problems, troubleshooting 118
- film, transparency. See transparencies
- first page, different 55
- Fit to Page option 54
- flashing lights 101
- fraud hotline 93
- 4-Color option 65

G

- gray background, troubleshooting 111
- grayscale
 - troubleshooting 115
- grayscale printing
 - selecting 53

H

- halftone options 64

- heavy paper
 - printing on 51
 - specifications 17
- Help 123
 - See *a/so* customer support
- HP built-in networking
 - information page, printing 80
- HP customer care iii
- HP fraud hotline 93
- HP ImageREt 2400 62
- HP LaserJet glossy paper
 - printing 48
- HP LaserJet paper 127
- HP LaserJet photo paper
 - media 48
- HP multipurpose paper 127
- HP Printing Supplies Returns and Recycling Program 141
- HP SupportPack 134, 143
- HP Toolbox
 - calibrating printer 96
 - device settings 86
 - operating systems supported 9
 - toner level, checking from 92
 - using 84
- HP toolbox
 - other links 86
- humidity specifications
 - paper, storing 14
 - printer environment 138

I

- image quality
 - HP ImageREt 2400 62
 - print, troubleshooting 109, 110
- ImageREt 2400 62
- indicator lights, device control panel
 - error messages 101
- information pages, printing 80
- ink cartridges. See print cartridges
- input trays
 - features 5
 - feeding problems, troubleshooting 118
 - jams, clearing 107
 - loading 40
 - media supported 17
 - part numbers 126
 - selecting 52
- interface ports
 - cables, ordering 125
 - types included 5
- Internet Explorer, versions supported 84
- IP address 73
- IP addressing 26

J

- jams
 - causes of 105
 - input areas 107
 - inside printer 106
 - output areas 108

K

- keys, control panel 19

L

- labels
 - printing 46
 - specifications 16, 17
- language
 - information pages 80
- laser safety statements 145
- LaserJet paper 127
- LaserWriter 8 driver 11
- letterhead
 - printing 50
- life expectancies, supplies 92
- light print, troubleshooting 110
- lightness
 - faded print, troubleshooting 110
- lights
 - locating 19
- lines, troubleshooting
 - printed pages 111
- loading media
 - tray 1 40
 - tray 2 41
- loose toner, troubleshooting 112

M

- Macintosh
 - driver features 53
 - features supported 9
 - printing from 56
 - software features 11
 - uninstalling software 12
- Magenta cartridge
 - life expectancy 92
 - part number 124
 - status gauge 20
 - See *a/so* cartridges
- mailing labels
 - printing 46
 - specifications 16, 17
- maintenance
 - agreements 134, 143
 - replacing print cartridges 92
- Manual color options 64
- manual duplexing 58
- manuals 86, 130
- margins, envelopes 14
- matching, color 66

Material Safety Data Sheet 143
media

- cardstock 51
- curled, troubleshooting 113
- custom-sized 51, 53
- envelopes 14, 44
- first page, different 55
- HP LaserJet glossy paper 48
- HP LaserJet photo paper 48
- HP, ordering 127
- jams 105
- labels 16, 46
- letterhead 50
- loading trays 40
- selecting 13
- specifications 13
- transparencies 16, 47
- tray 1, types supported 17
- tray 2, types supported 17
- tray 3, types supported 17
- troubleshooting 116
- wrinkled 114

mercury specifications 142

messages

- control panel 101

messages, error 101

messaging and management, network 25

Microsoft Windows. See Windows

monitors, color matching 66

multiple pages per sheet 54

multipurpose paper, HP 127

N

N-up printing 54

Netscape Navigator, versions supported 84

network

- AutoIP configuration 27
- BOOTP/TFTP 29
- configuring 23, 24
- device discovery 25
- device set up 73
- DHCP 32
- discontinue DHCP configuration 36
- embedded Web server 38
- IP address 73
- IP addressing 26
- manual TCP/IP configuration 27
- messaging and management 25
- NetWare systems 35
- server-based configuration 27
- static IP address 74
- supported protocols 25
- TCP/IP configuration 27
- TCP/IP configuration tools 28
- UNIX systems 32
- using printer control panel 37
- Windows systems 32

network password

- set up 73

networks

- information pages, printing 80

Neutral Grays options 65

non-HP print cartridges 93

O

on-site service agreements 143

online customer support iii

operating environment, specifications 138

operating systems supported 9

optional 250-sheet tray. See tray 3

optional tray 3. See tray 3

options. See settings

ordering supplies and accessories 124

other links 86

output bin

- features 5

output bin extender 7

output bins

- jams, clearing 108

output quality

- HP ImageREt 2400 62

- print, troubleshooting 109, 110

overhead transparencies

- specifications 16, 17

ozone specifications 141

P

packaging printer 135

Page Setup 52

pages

- blank 118

- not printing 119

- printing slowly 118

- skewed 113, 117

pages per minute 5

pages per sheet 54

paper

- cardstock 51

- curled, troubleshooting 113

- custom-sized 51, 53

- first page, different 55

- HP, ordering 127

- jams 105

- letterhead 50

- loading trays 40

- selecting 13

- specifications 13

- tray 1, types supported 17

- tray 2, types supported 17

- tray 3, types supported 17

- troubleshooting 116

- wrinkled 114

- paper input trays
 - features 5
 - feeding problems, troubleshooting 118
 - jams, clearing 107
 - loading 40
 - media supported 17
 - part numbers 126
 - selecting 52
- paper output bin
 - features 5
- paper output bins
 - jams, clearing 108
- parts
 - part numbers 124
 - user replaceable 129
- paused printing 21
- phone numbers
 - HP fraud hotline 93
 - HP Printing Supplies Returns and Recycling Program 142
 - support iii
- pick-up rollers, ordering 129
- platforms supported 9
- ports
 - cables, ordering 125
 - types included 5
- power
 - consumption 141
 - requirements 137
- preprinted paper
 - printing on 50
- print cartridge
 - replacing 75
- print cartridges
 - HP fraud hotline 93
 - life expectancy 92
 - part numbers 124
 - recycling 141
 - replacing 93
 - status gauge 20
 - status page, printing 81
 - storage specifications 138
- Print dialog box 52
- print media. *See* media
- print quality
 - HP ImageREt 2400 62
 - settings 109
 - specifications 5
 - troubleshooting 109, 110
- print servers
 - information page, printing 80
- printer driver, Macintosh 11
- printer drivers
 - downloading 10
 - features 53
 - opening 52
 - operating systems supported 9
 - restoring default settings 55
 - settings, changing 56
 - uninstalling 11
 - Windows, features 10
- printing
 - both sides 58
 - canceling 60
 - Macintosh 56
 - troubleshooting 118, 119
 - Windows 55
- printing environment 25
- problem solving. *See* troubleshooting
- programs, settings 9
- properties. *See* settings

Q

- quality
 - HP ImageREt 2400 62
 - print settings 109
 - print, troubleshooting 109, 110
 - specifications 5
- Quick Sets 54

R

- Readme 86
- Ready light 21, 123
 - See also* lights
- ready light and select button 21
- rear output door
 - features 5
- recycling
 - plastics 141
 - print cartridges 141
- reducing documents 54
- refilled print cartridges 93
- refilling paper 40
- regulatory statements
 - declaration of conformity 144
 - FCC 140
 - laser safety 145
 - Material Safety Data Sheet 143
- repacking printer 135
- repair. *See* service
- repetitive defects, troubleshooting 114
- replacement parts. *See* supplies\service
- replacing print cartridges 93
- reports, printing 80
- resizing documents 54
- resolution
 - HP ImageREt 2400 62
 - print settings 109
 - specifications 5
- restoring default settings 55
- resuming printing 21
- RGB color options 65, 66
- rollers, ordering 129

- S**
- saving settings 54
- scaling documents 54
- scanners, color matching 66
- scatter, troubleshooting 114
- screen color matching 66
- separation pad, ordering 129
- servers
 - information page, printing 80
- service
 - agreements 134, 143
 - information form 136
 - part numbers 124
 - repacking printer 135
- set up
 - device 73
 - network password 73
- settings
 - changing 9, 56
 - color 64
 - restoring defaults 55
 - saving 54
- shipping printer 135
- size, printer 137
- sizes, media
 - custom 51, 53
 - selecting trays 52
- skewed pages 113, 117
- smeared toner, troubleshooting 112
- Smooth halftone option 64
- software
 - downloading 10
 - features 53
 - Macintosh, features 11
 - operating systems supported 9
 - settings, changing 56
 - Toolbox 84
 - uninstalling 11
 - Windows, features 10
- source, printing by 52
- spare parts. *See* supplies\service
- special media
 - cardstock 51
 - custom-sized 51, 53
 - envelopes 14, 44
 - HP LaserJet glossy paper 48
 - labels 16, 46
 - letterhead 50
 - specifications 17
 - transparencies 16
- specifications
 - envelopes 14
 - environmental 138
 - labels 16
 - Material Safety Data Sheet 143
 - paper 13
 - printer 137
 - printer features 5
 - transparencies 16
 - trays, media supported 17
- specks, troubleshooting 111
- speed
 - specifications 5
- spots, troubleshooting 111
- sRGB 65, 66
- static IP address 74
- status
 - lights. *See* lights
 - Supplies Status page, printing 81
 - viewing with HP Toolbox 85
- Status tab, HP Toolbox 85
- stopping printing 60
- storing
 - envelopes 15
 - paper 14
 - print cartridges 93
 - printer 138
- streaks, troubleshooting 111
- supplies
 - availability 143
 - life expectancies 92
 - recycling 141
 - specifications 137
 - status gauge 20
 - status page 81
- support
 - maintenance agreements 134, 143
 - part numbers 124
 - repacking printer 135
 - service information form 136
- supported network protocols 25
- SupportPack, HP 134, 143
- T**
- TCP/IP configuration 27
- technical support
 - maintenance agreements 134, 143
 - part numbers 124
 - repacking printer 135
 - service information form 136
- telephone numbers
 - HP fraud hotline 93
 - HP Printing Supplies Returns and Recycling Program 142
 - support iii
- temperature specifications
 - paper, storing 14
 - printer environment 138

- text, troubleshooting
 - misformed characters 113
 - toner
 - loose, troubleshooting 112
 - scatter, troubleshooting 114
 - smear, troubleshooting 112
 - specks, troubleshooting 111
 - status gauge 20
 - toner cartridges. *See* print cartridges
 - Toolbox
 - operating systems supported 9
 - using 84
 - top output bin
 - features 5
 - transparencies
 - specifications 16, 17
 - Trapping options 65
 - tray 1
 - loading 40
 - See also* trays
 - tray 2
 - loading 41
 - See also* trays
 - tray 3
 - loading 41
 - part number 126
 - See also* trays
 - trays
 - features 5
 - feeding problems, troubleshooting 118
 - jams, clearing 107
 - loading 40
 - media supported 17
 - part numbers 126
 - selecting 52
 - troubleshooting
 - blank pages 118
 - calibrating printer 96
 - color 114
 - Configuration page, printing 80
 - control panel messages 101
 - curled media 113
 - Demo page, printing 80
 - faded print 110
 - feeding problems 118
 - jams 105
 - lines, printed pages 111
 - loose toner 112
 - pages not printing 119
 - pages printing slowly 118
 - paper 116
 - print quality 109
 - repetitive defects 114
 - replacing print cartridges 93
 - skewed pages 113, 117
 - text 113
 - toner scatter 114
 - toner smear 112
 - toner specks 111
 - USB cables 119
 - wrinkles 114
 - Troubleshooting tab, HP Toolbox 85
 - two-sided printing 58
 - typefaces. *See* fonts
 - types, media
 - selecting trays by 52
- U**
- uninstalling software 11
 - universal tray. *See* tray 2
 - universal tray 2. *See* tray 2
 - USB port
 - troubleshooting 119
 - type included 5
 - user guide
 - accessing 86
 - part numbers 130
 - user replaceable parts 129
- V**
- vertical lines, troubleshooting 111
 - voltage requirements 137
- W**
- warranty
 - extended 134, 143
 - print cartridge 133
 - product 131
 - watermarks 53
 - wavy paper, troubleshooting 113
 - Web browser requirements 84
 - websites
 - customer support iii
 - HP Printing Supplies Returns and Recycling Program 142
 - Material Safety Data Sheet 143
 - weight
 - printer 137
 - Windows
 - driver features 53
 - printing from 55
 - settings 56
 - uninstalling software 11
 - versions supported 9
 - wrinkles, troubleshooting 114
- Y**
- Yellow cartridge
 - life expectancy 92
 - part number 124
 - status gauge 20
 - See also* cartridges

© 2005 Hewlett-Packard Development Company, L.P.

www.hp.com



Q6455-90937